

707

StartupBoeing



707 Series Lower Hold

StartupBoeing

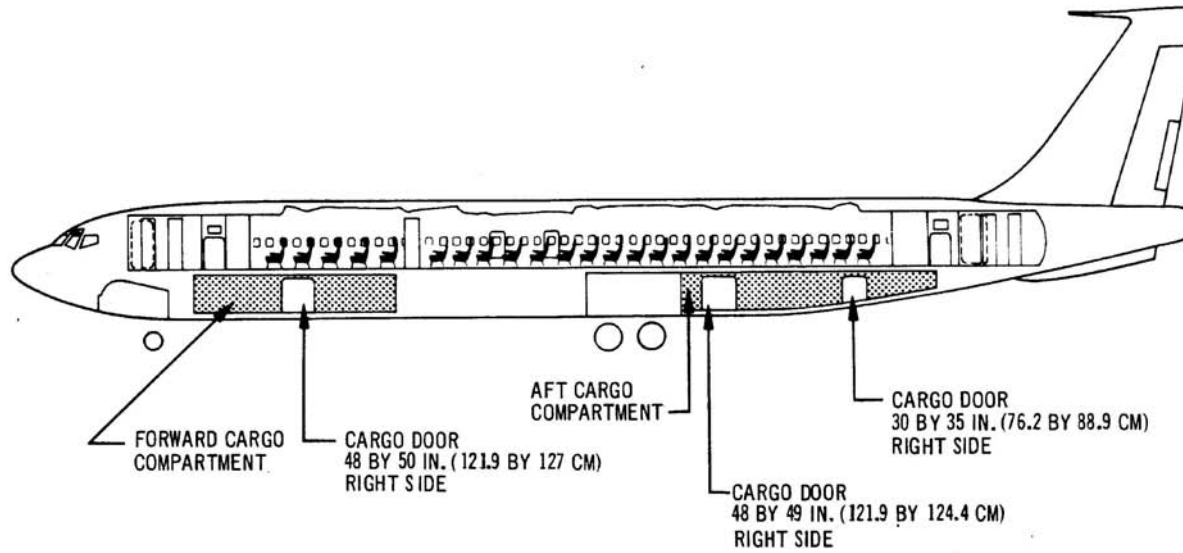

LOWER CARGO COMPARTMENT CAPACITIES

MODEL	FORWARD		AFT		TOTAL	
	CU FT	CU M	CU FT	CU M	CU FT	CU M
707-120B	758	21.46	910	25.76	1,668	47.22
707-320/-420	868	24.58	905	25.63	1,773	50.21
707-320B	865	24.49	905	25.63	1,770	50.12
707-320C (CONV)	835	23.60	865	24.49	1,700	48.09
707-320C (F)	875	24.80	910	25.76	1,785	50.56

NOTE: CARGO IN LOWER COMPARTMENTS NOT USUALLY CONTAINERIZED; HOWEVER, INDIVIDUAL AIRLINES HAVE OPTION OF USING CONTAINERS.

707-120B General Arrangement

StartupBoeing

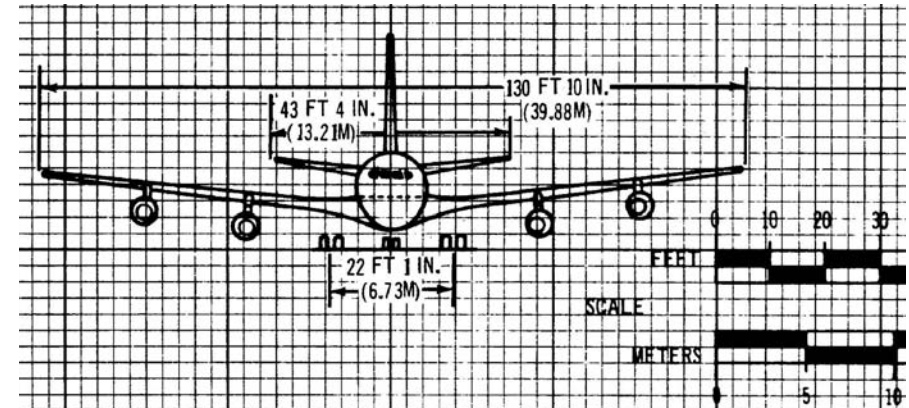
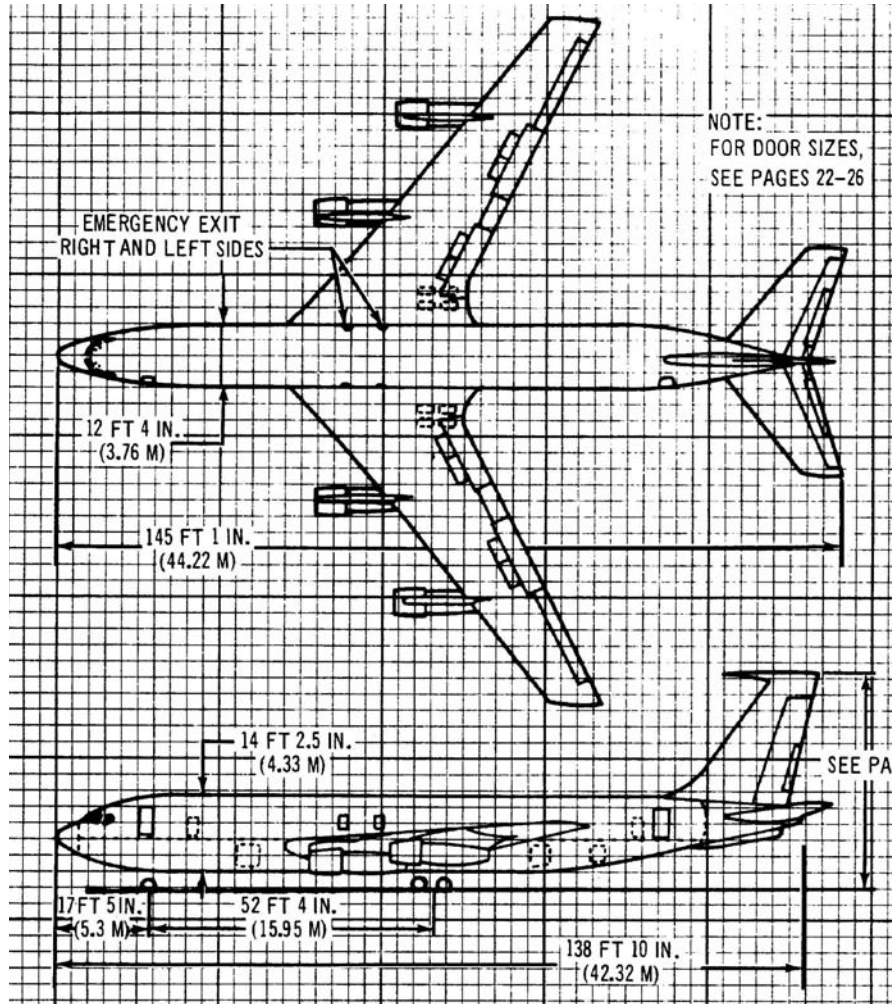

707-320/-420 General Arrangement

StartupBoeing

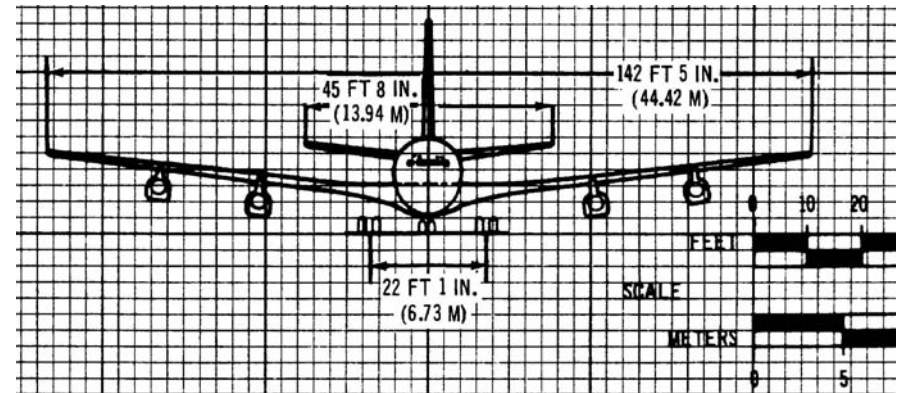
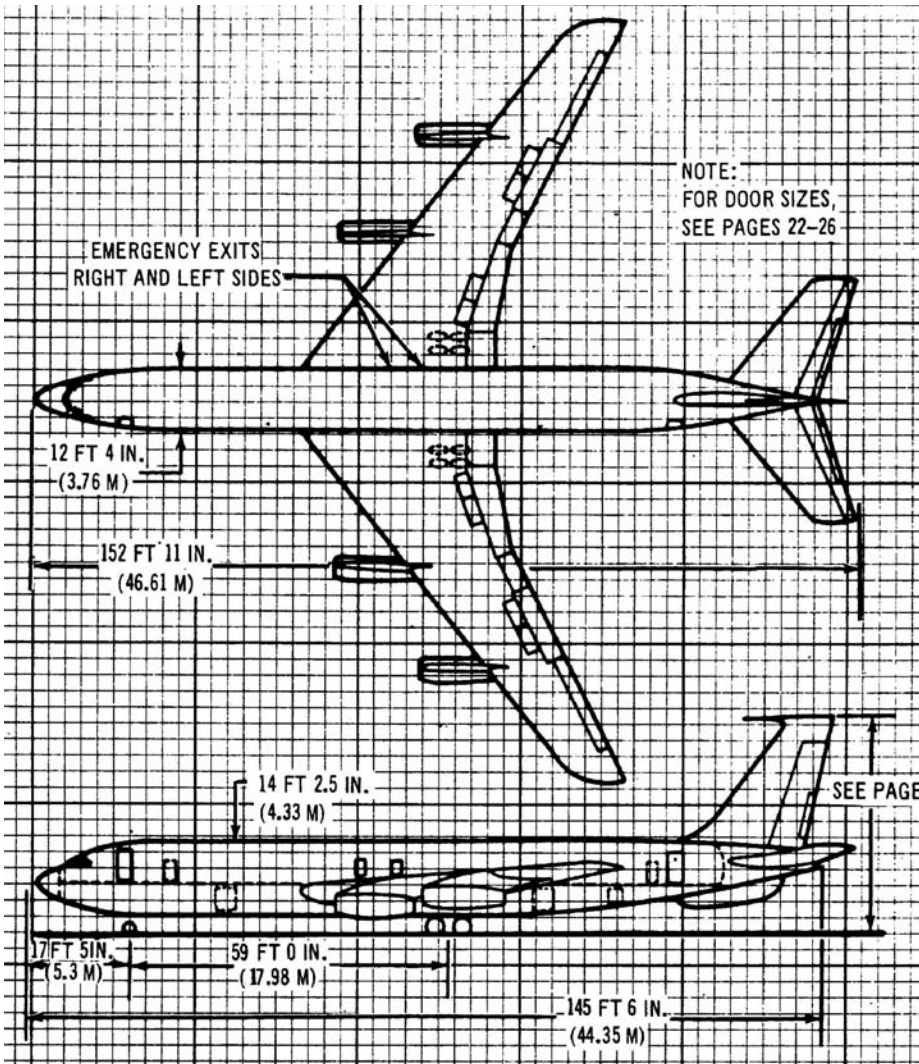

707-320B/-320C General Arrangement

StartupBoeing

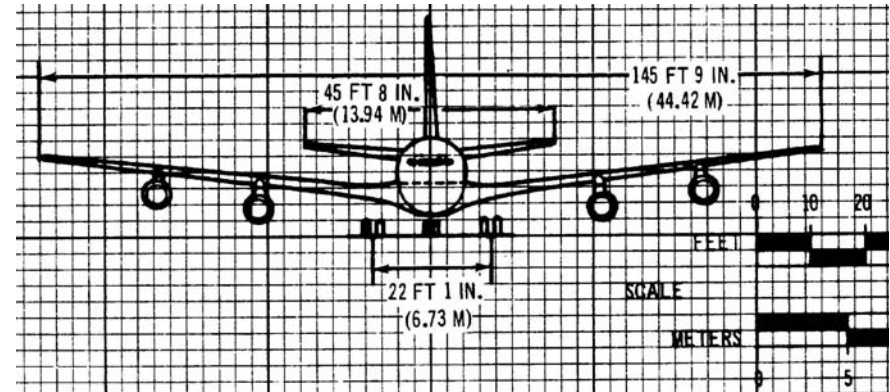
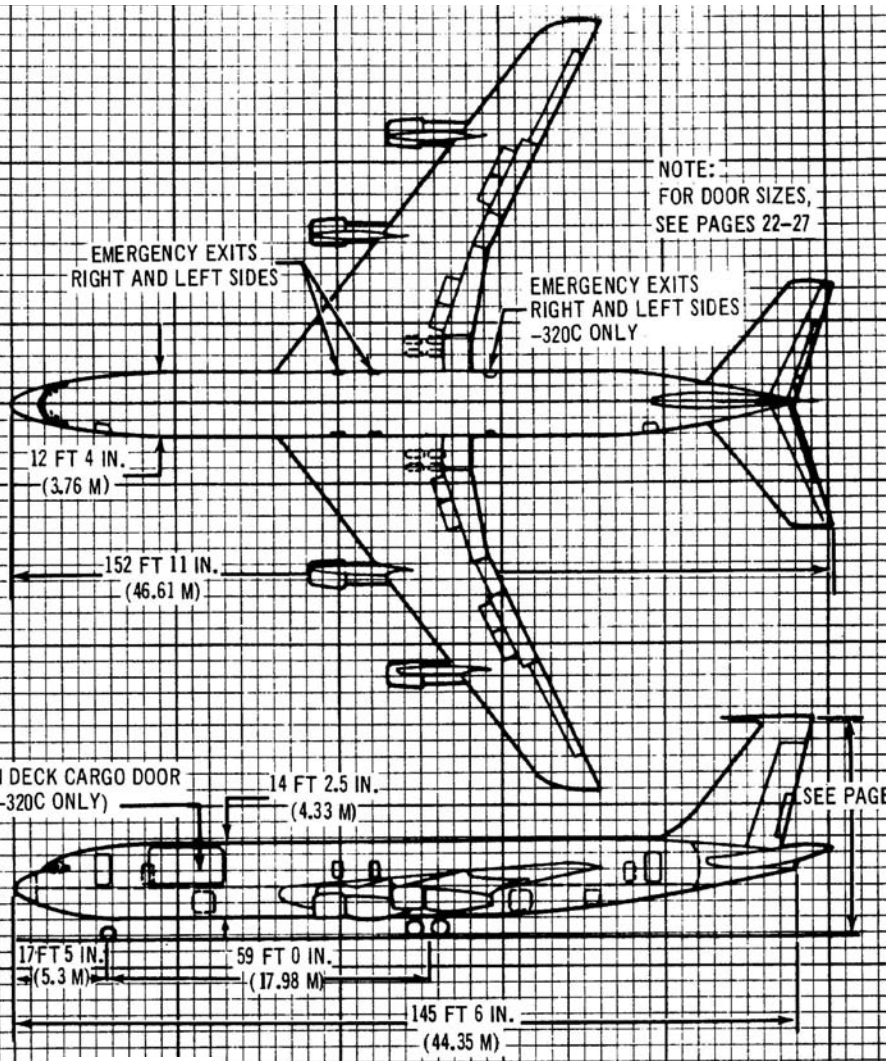

707-120B Interior Arrangements

StartupBoeing

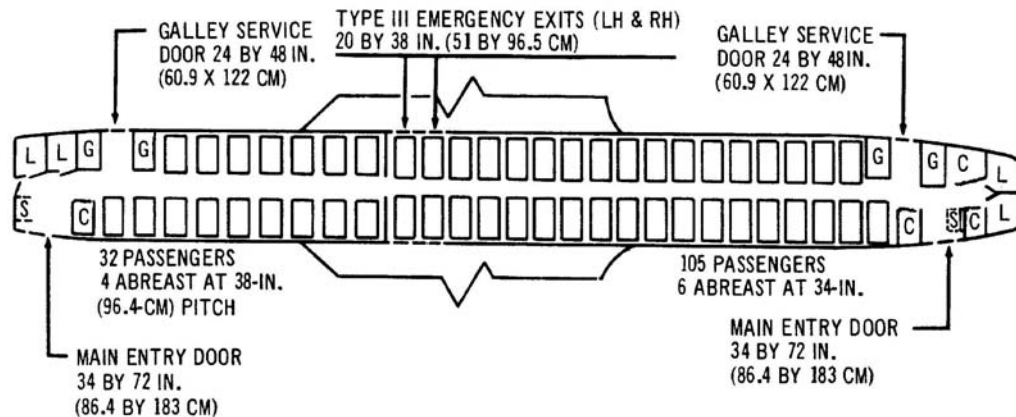

137 PASSENGERS—MIXED CLASS (DOMESTIC)

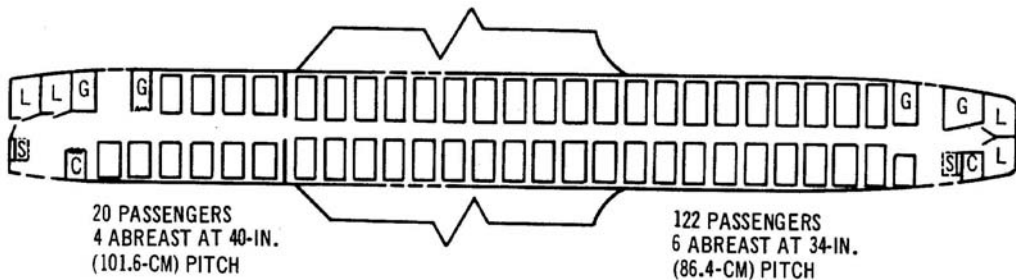

142 PASSENGERS – MIXED CLASS (INTERNATIONAL)

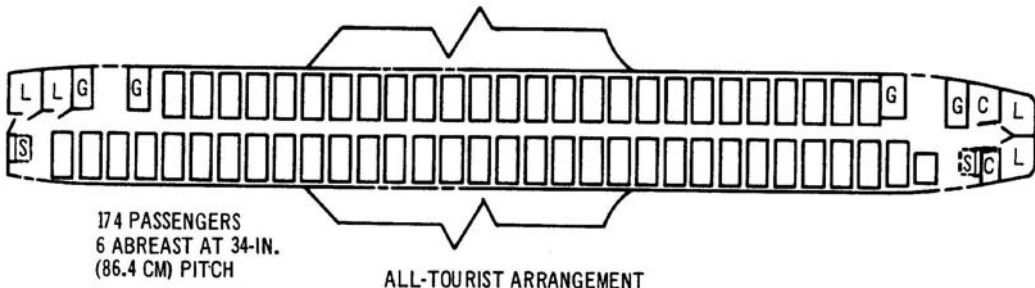

ALL-TOURIST ARRANGEMENT

- C CLOSET
- G GALLEY
- L LAVATORY
- S DOUBLE ATTENDANTS SEAT

707-320/-320B/-420 Interior Arrangements

StartupBoeing

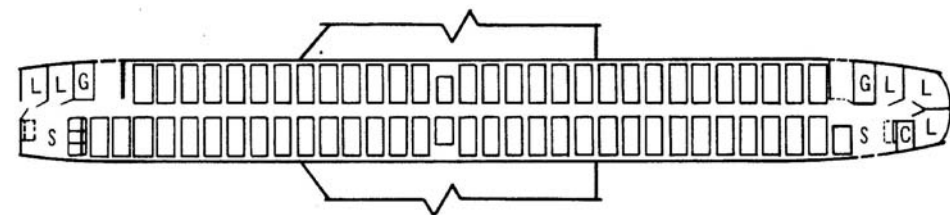
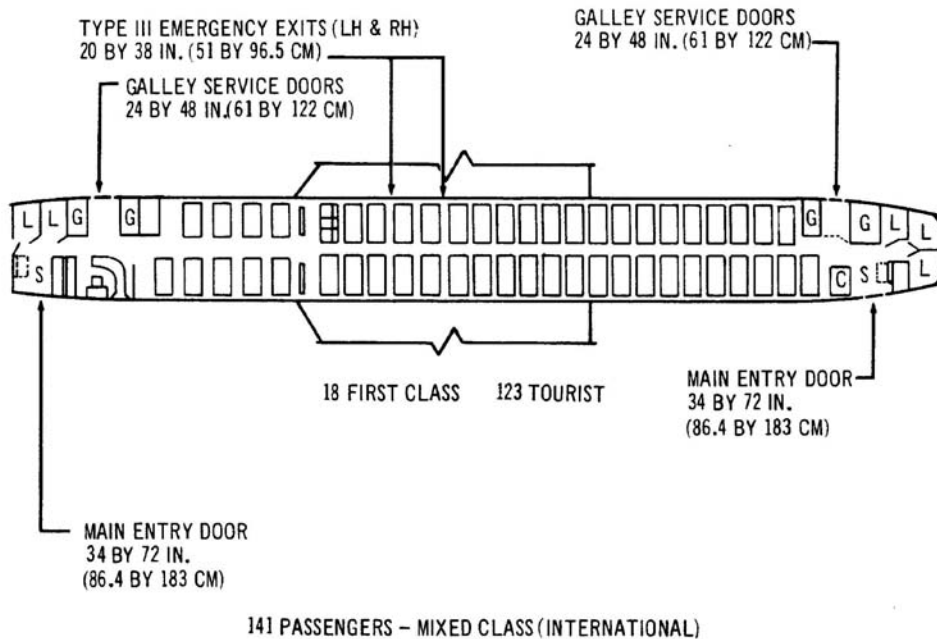

- C** CLOSET
- G** GALLEY
- L** LAVATORY
- S** DOUBLE ATTENDANTS SEAT

707-320C Interior Arrangements

StartupBoeing

THREE TO 10 PALLETS CAN BE ACCOMMODATED IN MIXED CARGO/PASSENGER CONFIGURATIONS. VARIOUS COMBINATIONS ARE SHOWN BELOW.

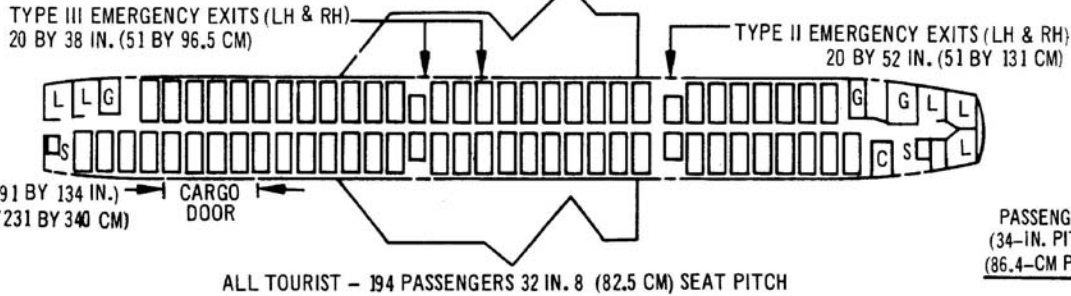

PASSENGERS
(34-IN. PITCH)
(86.4-CM PITCH)

- 187
- 131
- 115
- 103
- 87
- 69
- 57
- 33
- 29
- 0
- 0

PALLETS
NO. SIZE
IN. (CM)

NO.	SIZE	IN.	(CM)
0	88 BY 108	223 BY 274	
3	88 BY 108	223 BY 274	
4	88 BY 108	223 BY 274	
5	88 BY 108	223 BY 274	
6	88 BY 108	223 BY 274	
7	88 BT 108	223 BY 274	
8	88 BT 108	223 BY 274	
9	88 BT 108	223 BY 274	
10	88 BY 108	223 BY 274	
13	88 BY 108 (BASIC)	223 BY 274	
13	88 BY 125 (OPTIONAL)	223 BY 318	

TOTAL CARGO VOLUMES
(INCLUDING LOWER CARGO COMPARTMENTS)

CU FT	(CU M)
1,700	(48.14)
2,906	(82.30)
3,317	(93.94)
3,728	(105.58)
4,139	(117.22)
4,550	(128.86)
4,961	(140.50)
5,372	(152.14)
5,783	(163.77)
7,022	(198.86)
7,630	(216.08)

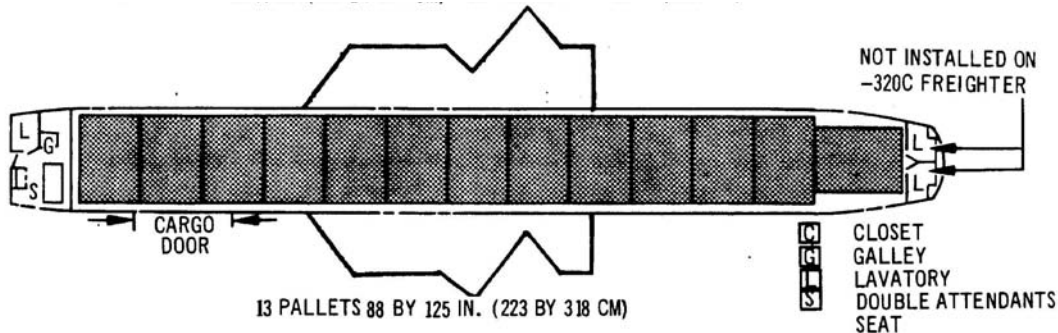
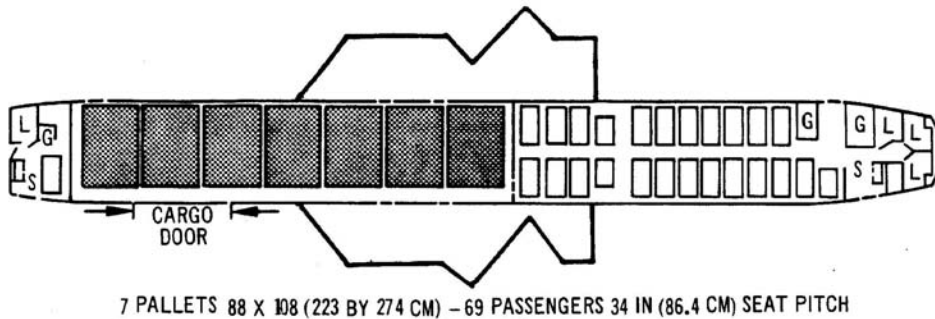

707 Series Cross Section

StartupBoeing

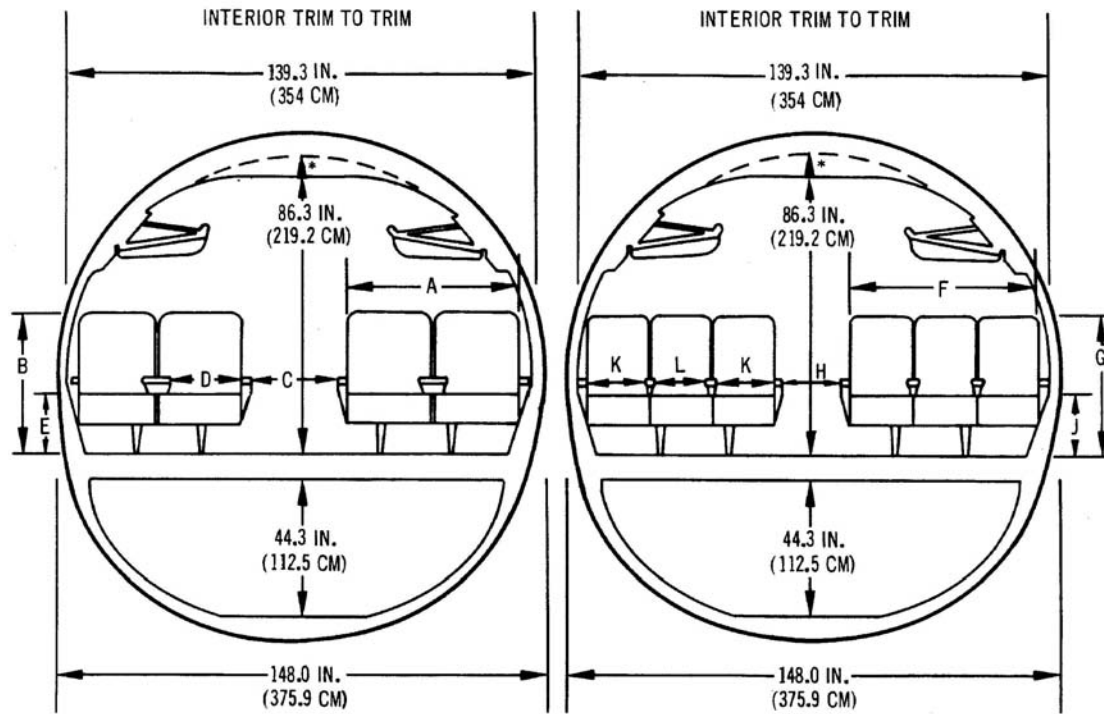

* 9.1.3 IN. (232 CM) -320C ONLY

	IN.	CM
A	47.4	120.4
B	42.6	107.9
C	28.0	71.2
D	20.0	50.8
E	17.9	45.5

FIRST CLASS

	IN.	CM
F	54.4	138.2
G	42.6	107.9
H	18.0	45.7
J	17.9	45.5
K	16.5	41.9
L	17.6	44.7

TOURIST

707 Series Lower Hold

StartupBoeing

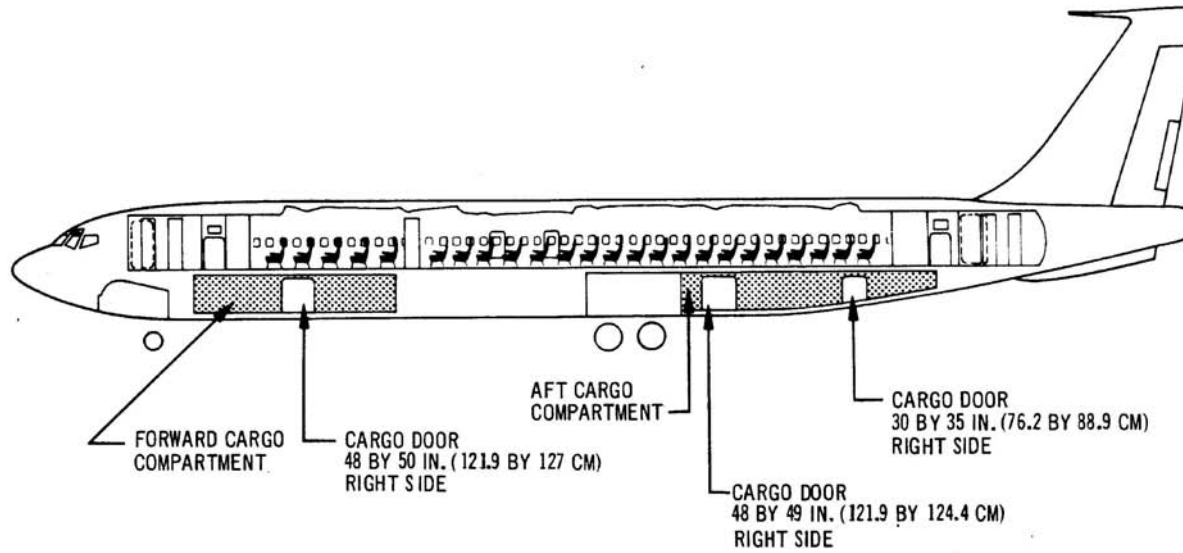

LOWER CARGO COMPARTMENT CAPACITIES

MODEL	FORWARD		AFT		TOTAL	
	CU FT	CU M	CU FT	CU M	CU FT	CU M
707-120B	758	21.46	910	25.76	1,668	47.22
707-320/-420	868	24.58	905	25.63	1,773	50.21
707-320B	865	24.49	905	25.63	1,770	50.12
707-320C (CONV)	835	23.60	865	24.49	1,700	48.09
707-320C (F)	875	24.80	910	25.76	1,785	50.56

NOTE: CARGO IN LOWER COMPARTMENTS NOT USUALLY CONTAINERIZED; HOWEVER, INDIVIDUAL AIRLINES HAVE OPTION OF USING CONTAINERS.

707 Series General Characteristics

StartupBoeing

AIRPLANE CHARACTERISTIC	UNIT OF MEASURE	MODEL						
		-120B	-320/-420	-320B		-320C		
						CONVERTIBLE		FREIGHTER
						PASSENGER	CARGO	
MAXIMUM RAMP WEIGHT	POUNDS	258,000	316,000	328,000	336,000	336,000	336,000	336,000
	KILOGRAMS	117,100	143,500	148,900	152,500	152,500	152,500	152,500
MAXIMUM LANDING WEIGHT	POUNDS	190,000	207,000	207,000	215,000	247,000	247,000	247,000
	KILOGRAMS	86,300	94,000	94,000	97,500	112,100	112,100	112,100
MAXIMUM TAKEOFF WEIGHT	POUNDS	257,340	312,000	327,000	333,600***	333,600***	333,600***	333,600***
	KILOGRAMS	117,000	141,700	148,500	151,500	151,500	151,500	151,500
OPERATING EMPTY WEIGHT (TYP)	POUNDS	127,500 **	142,600 *	142,780 **	148,800 *	155,100 *	148,300 *	135,500 *
	KILOGRAMS	57,600	64,600	64,700	67,500	70,500	67,300	61,500
ZERO FUEL WEIGHT	POUNDS	170,000	190,000	190,000	195,000	230,000	230,000	230,000
	KILOGRAMS	77,200	86,300	86,300	88,500	104,400	104,400	104,400
MAXIMUM STRUCTURAL PAYLOAD	POUNDS	42,500	47,400	47,220	46,200	74,900	81,700	94,500
	KILOGRAMS	19,300	32,500	21,400	21,000	34,000	37,100	42,900
MAXIMUM SEATING CAPACITY	ALL ECONOMY	174	189	189	189	194	—	—
MAXIMUM CARGO CAPACITY	CUBIC FEET	1,668	1,773	1,770	1,770	1,700	9,115	9,785
	CUBIC METERS	47.39	50.24	50.16	50.16	48.36	258.0	277.00
USABLE FUEL CAPACITY	U.S. GALLONS	17,330	23,820	23,855	23,855	23,855	23,855	23,855
	LITERS	65,590	90,160	90,290	90,290	90,290	90,290	90,290

NOTE: OEW'S SHOWN ARE AN AVERAGE AIRLINE VALUE.
IF SPECIFIC FIGURES ARE REQUIRED, CONSULT USING AIRLINE.

* INTERNATIONAL CONFIGURATION

** DOMESTIC CONFIGURATION

*** MAXIMUM TAKEOFF WEIGHT OF 335,000 POUNDS
IS POSSIBLE WHEN USING WET THRUST.