

DC-9

StartupBoeing



DC-9 Series General Arrangement

StartupBoeing

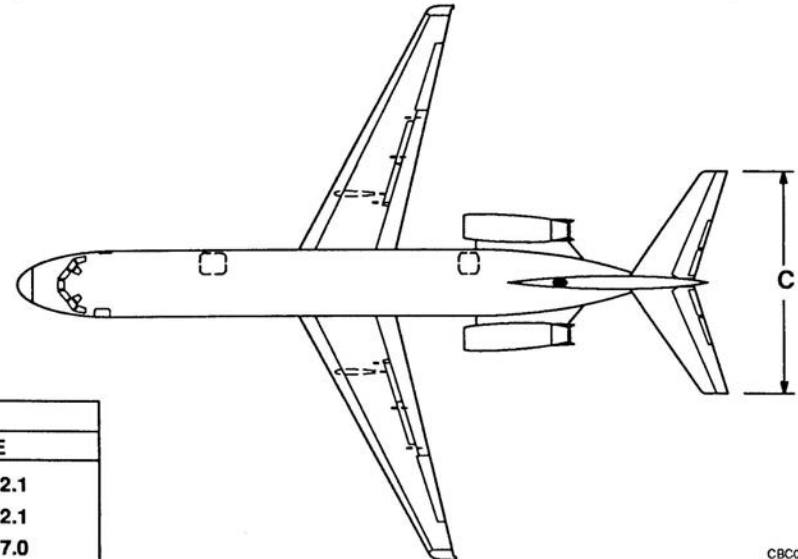
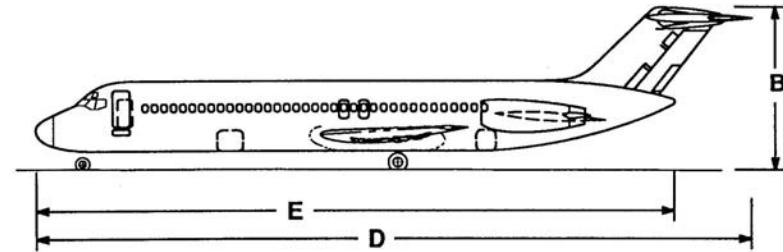
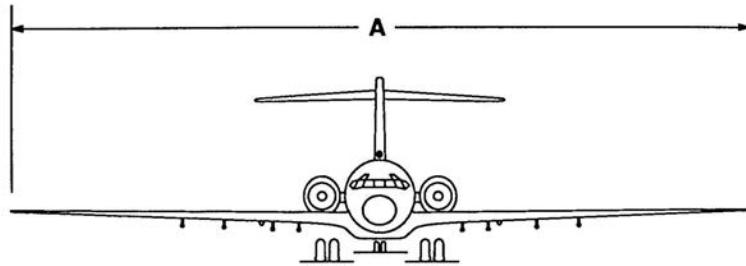

PHYSICAL DIMENSIONS

MODEL	DIMENSION (FT)				
	A	B	C	D	E
MODEL 10	89.4	27.5	36.9	104.4	92.1
MODEL 21	93.3	27.5	36.9	104.4	92.1
MODEL 30	93.3	27.5	36.8	119.3	107.0
MODEL 40	93.3	27.5	36.9	125.6	113.3
MODEL 50	93.3	27.5	36.9	133.5	121.2

CBC011

DC-9 Family

StartupBoeing

DC-9-10

BASIC FUSELAGE

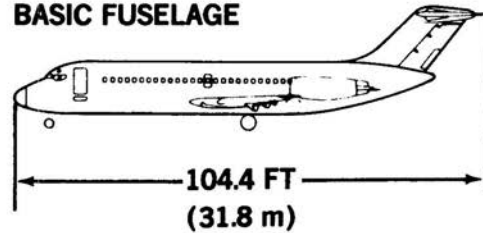

BASIC WING

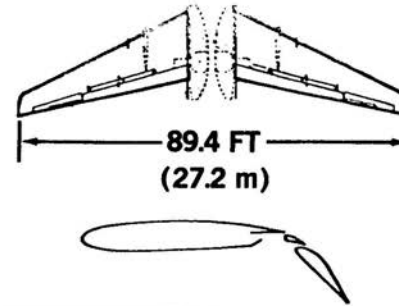

SAME AS DC-9-10



**179-IN. FUSELAGE EXTENSION
(455 cm)**



HIGH-LIFT WING

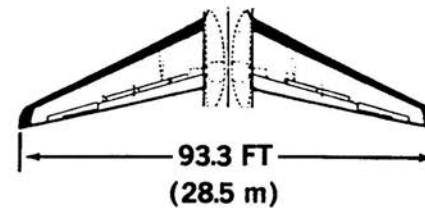

**255-IN. FUSELAGE EXTENSION
(648 cm)**

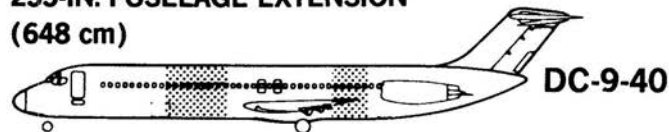

**350-IN. FUSELAGE EXTENSION
(889 cm)**



DC-9-10/-20 Interior Arrangements

StartupBoeing

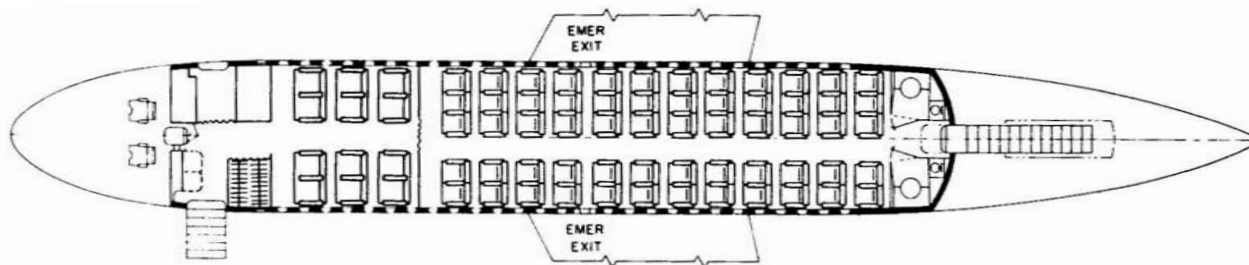

72 Mixed Class
12 First Class
38-In. Pitch
60 Coach Class
34-In. Pitch

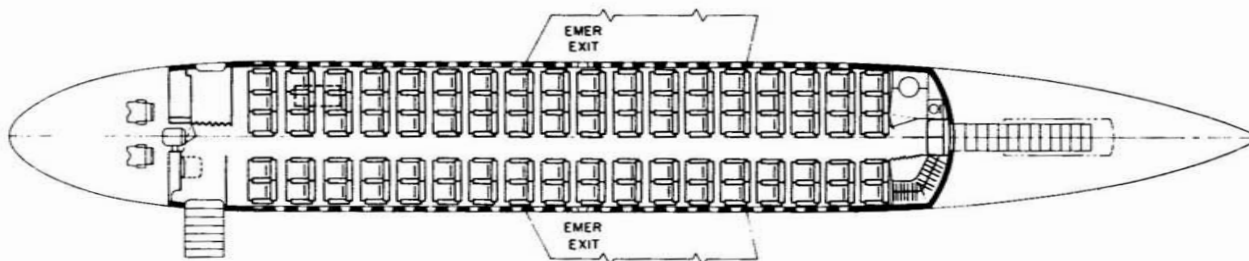

90 Coach Class
34-In. Pitch

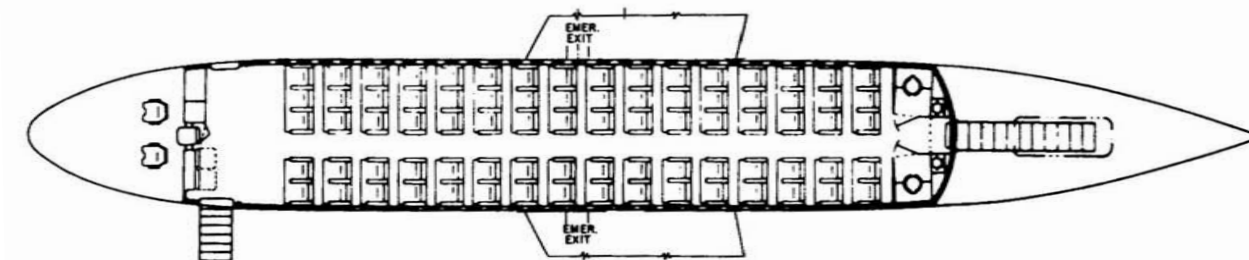

80 Coach Class
34-In. Pitch

DC-9-10RC Interior Arrangements

StartupBoeing

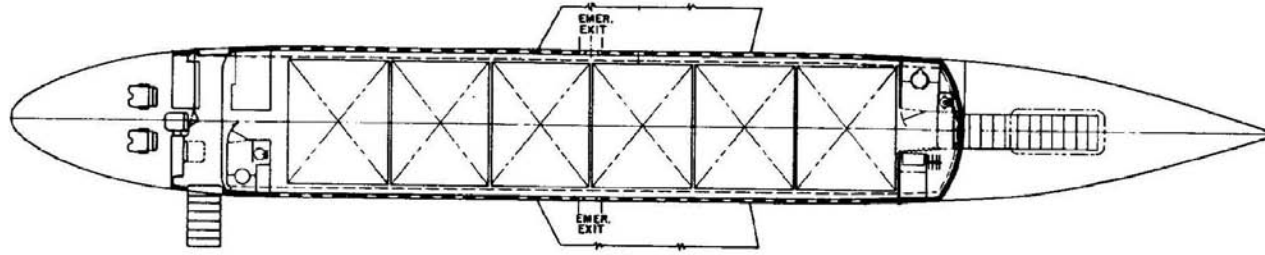

6 Pallets
88 x 108 In.

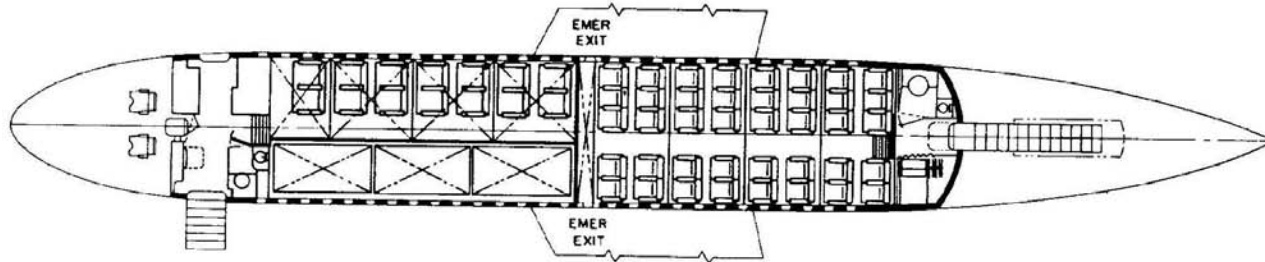

54 Mixed Class
14 First Class
38-In. Pitch
40 Coach Class
34-In. Pitch
3 Pallets 43 x 87 In.

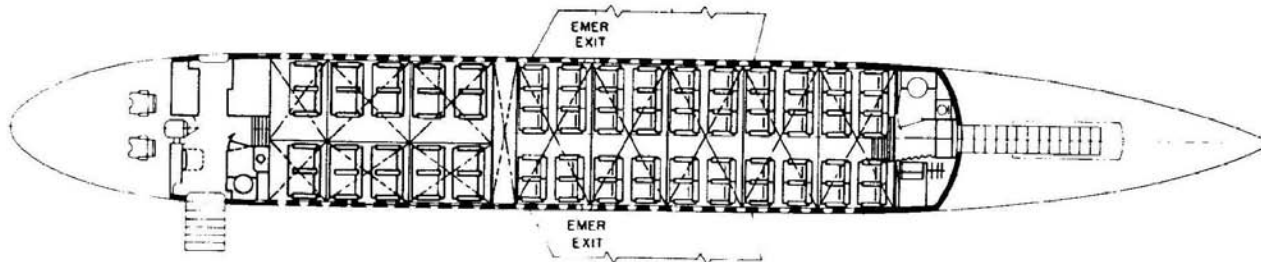

70 Mixed Class
20 First Class
38-In. Pitch
50 Coach Class
34-In. Pitch

DC-9-30 Interior Arrangements

StartupBoeing

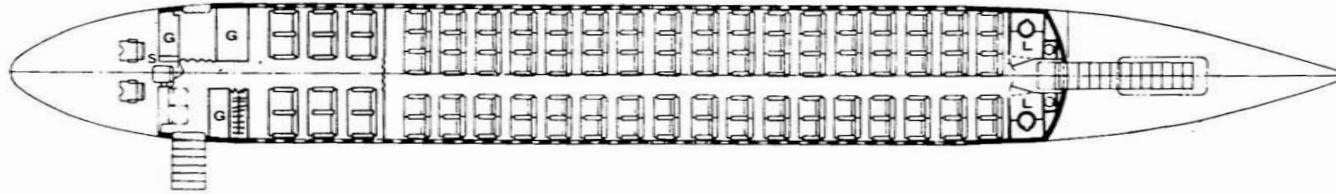

97 Mixed Class
12 First Class
38-in. Pitch
85 Coach Class
34-in. Pitch

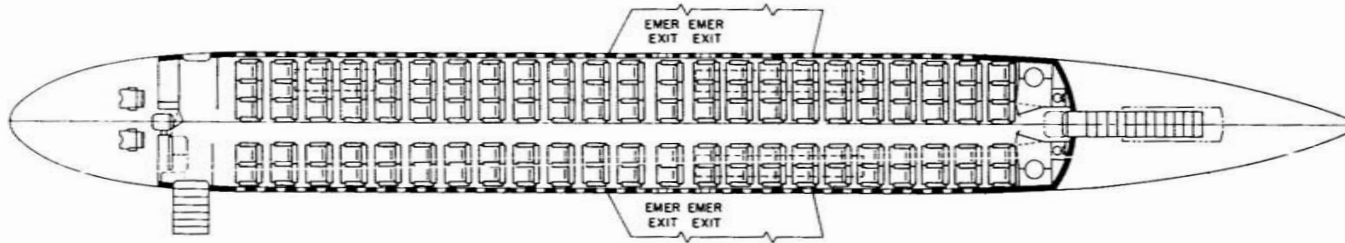

115 Single Class
32 In. Pitch

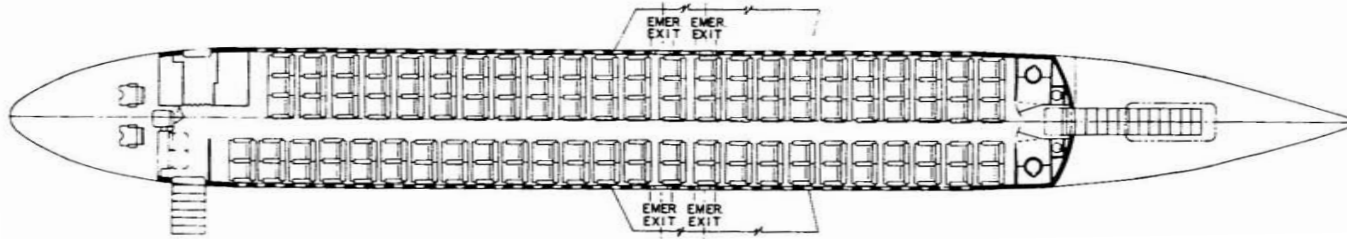

119 Single Class
29-, 30-, and 31-in. Pitch

DC-9-30RC Interior Arrangements

StartupBoeing

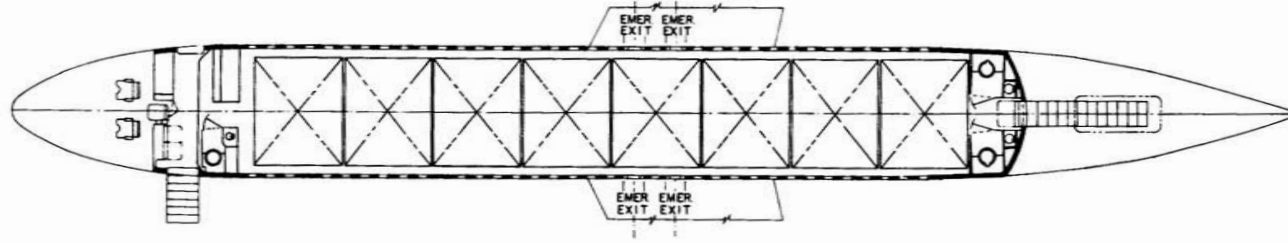

8 Pallets
88 x 108 In.

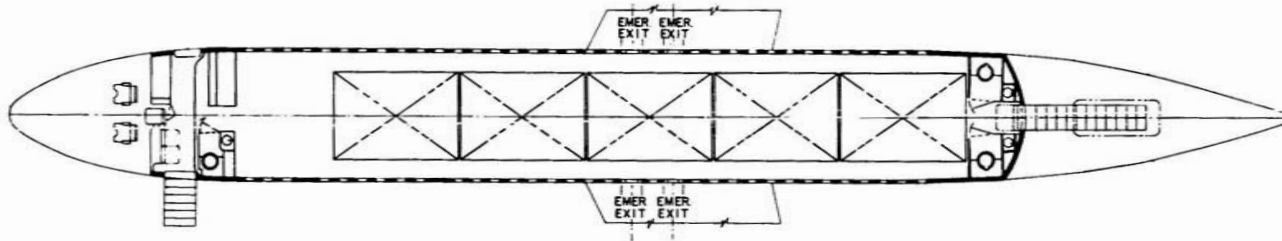

5 Pallets
88 x 125 In.

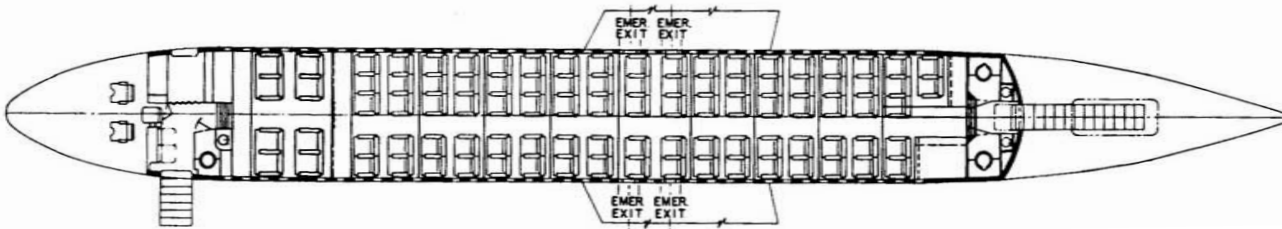

95 Mixed Class
8 First Class
38-In. Pitch
87 Coach Class
34-In. Pitch

DC-9-30CF Interior Arrangements

StartupBoeing

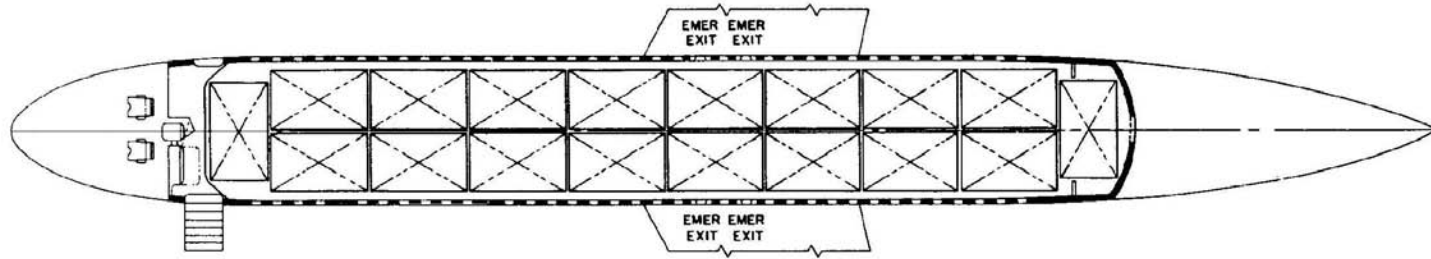

18 Pallets
54 x 88 in.

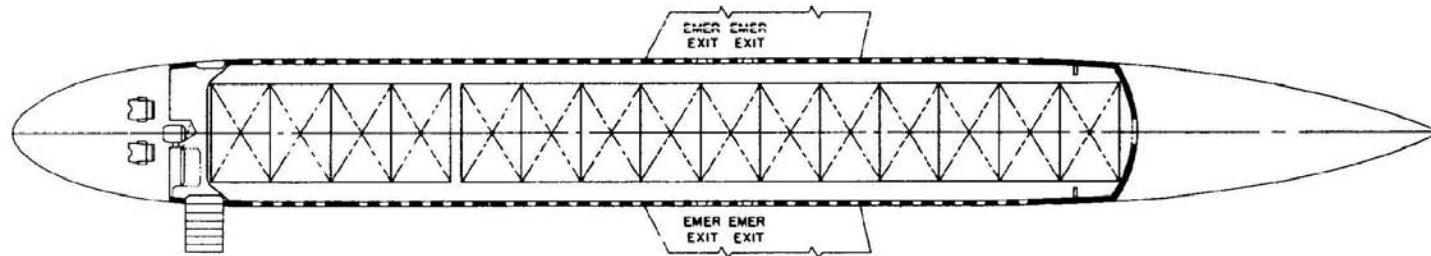

15 Pallets
54 x 88 in.

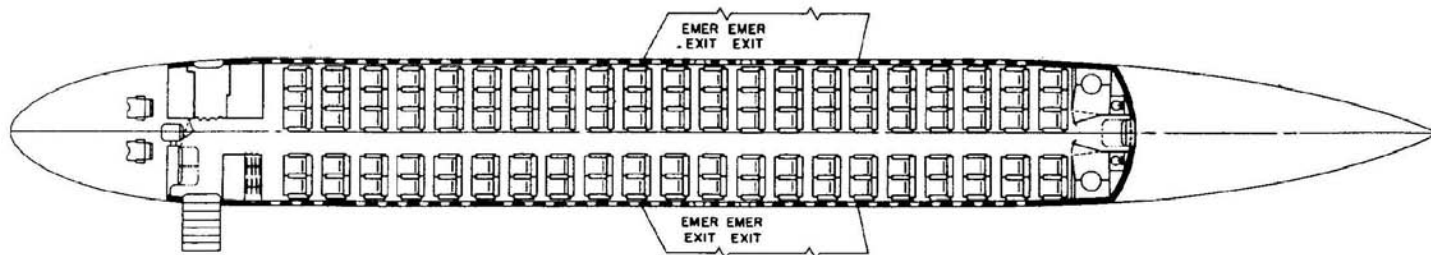

105 Coach Class
34-in. Pitch

DC-9-30AF Interior Arrangements

StartupBoeing

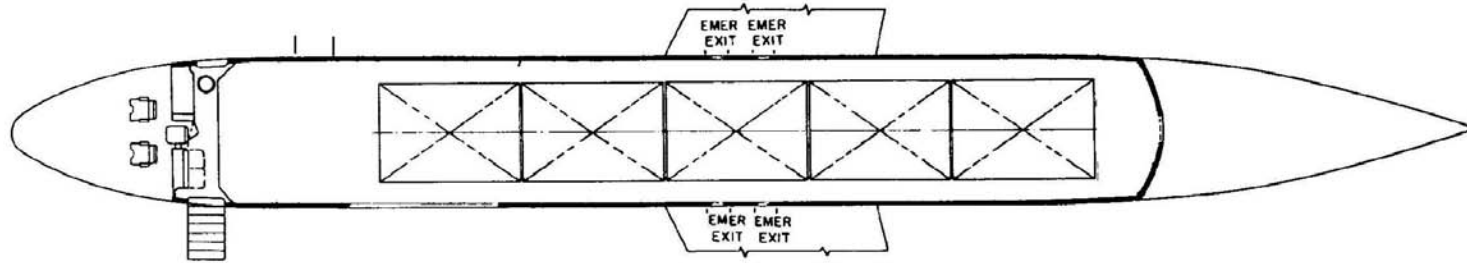

5 Pallets
88 x 125 In.

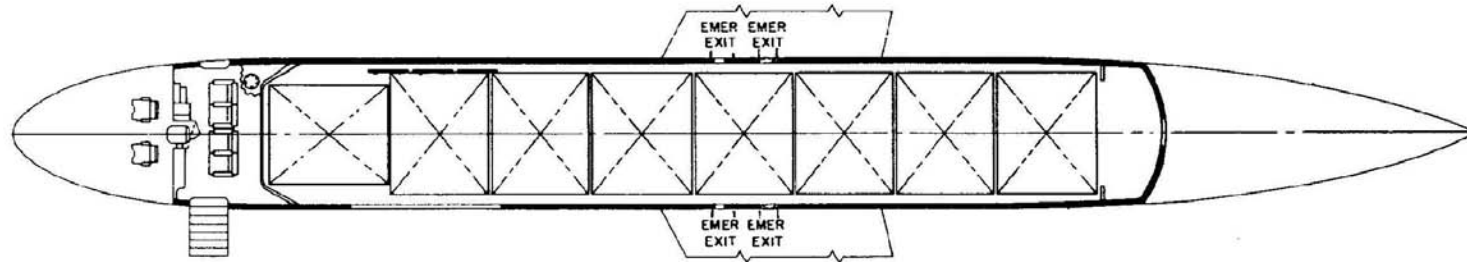

8 Pallets
88 x 108 In.

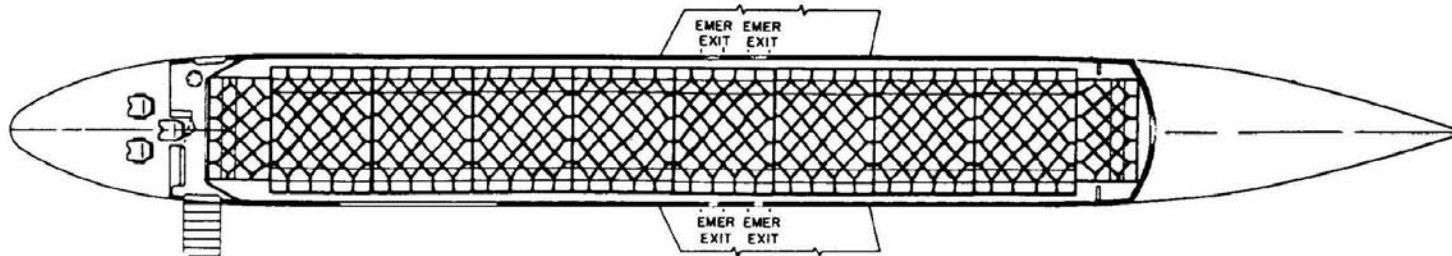

8 Pallets
88 x 108 In.
2 Pallets
88 x 54 In.

DC-9-40 Interior Arrangements

StartupBoeing

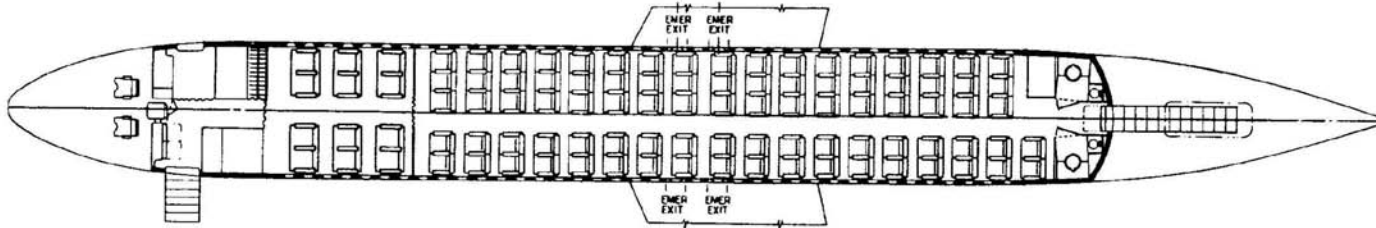

99 Mixed Class
12 First Class
37-in. Pitch
87 Coach Class
31-in. Pitch

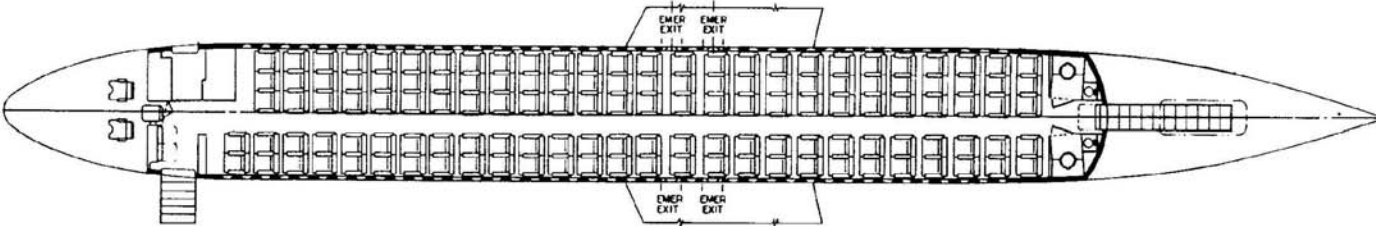

132 Single Class
29- and 31-in. Pitch

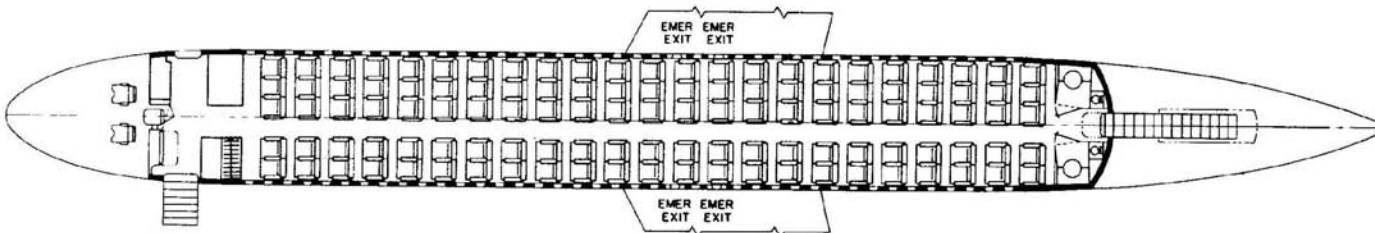

115 Coach Class
34-in. Pitch

DC-9-50 Interior Arrangements

StartupBoeing

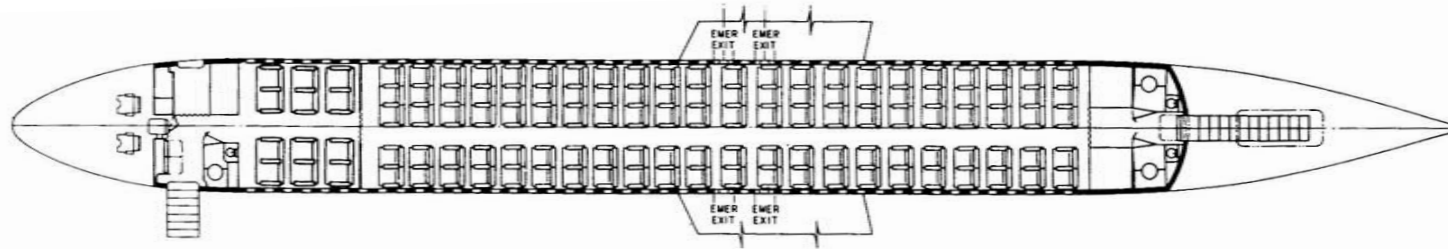

122 Mixed Class
12 First Class
35-in. Pitch
110 Coach Class
32-in. Pitch

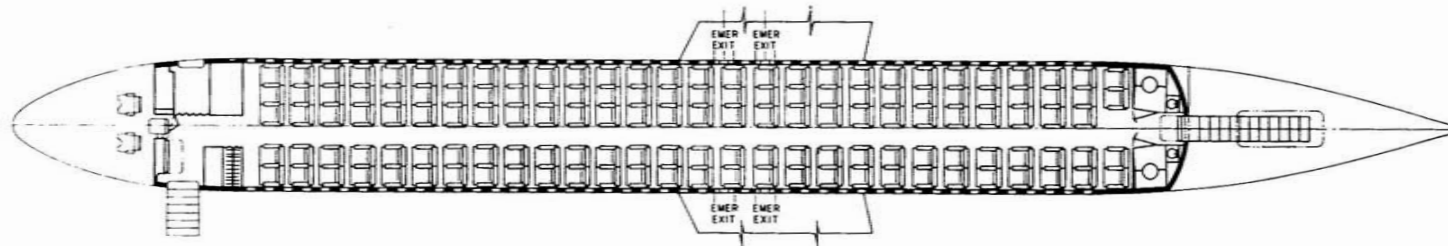

139 Single Class
31- and 32-in. Pitch

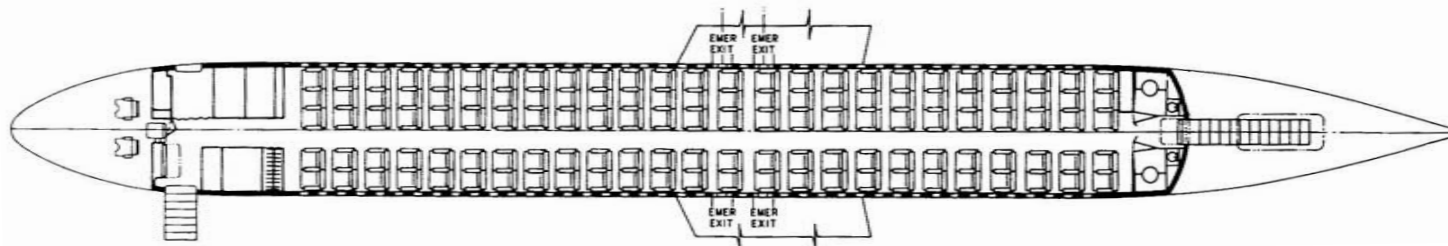

125 Coach Class
34-in. Pitch

DC-9 Cross Section

StartupBoeing

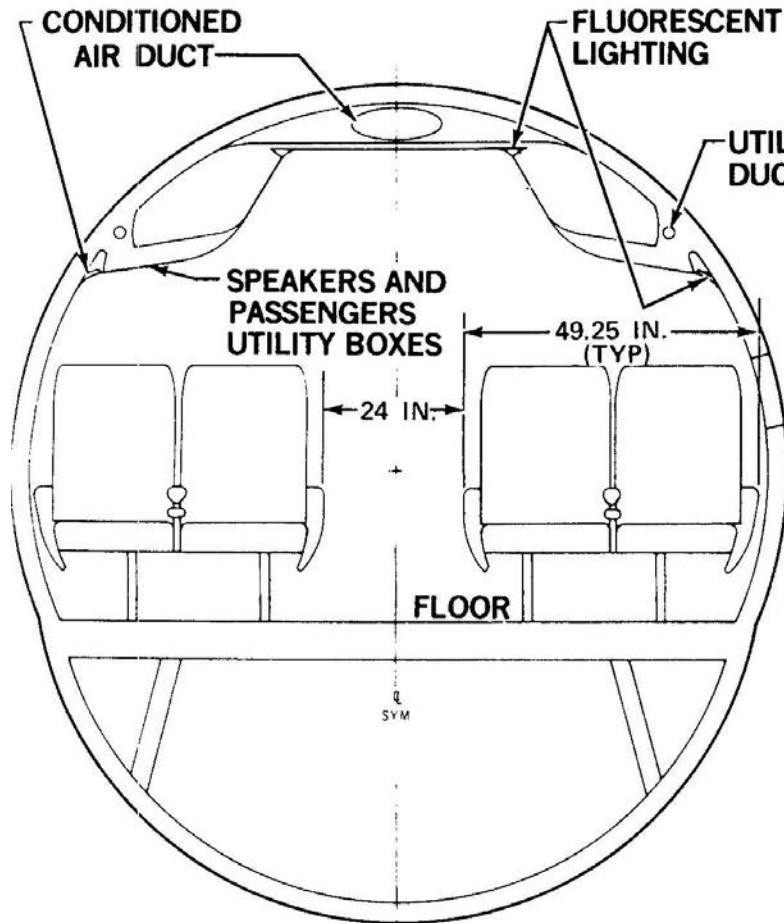

SEATING 4 ABREAST

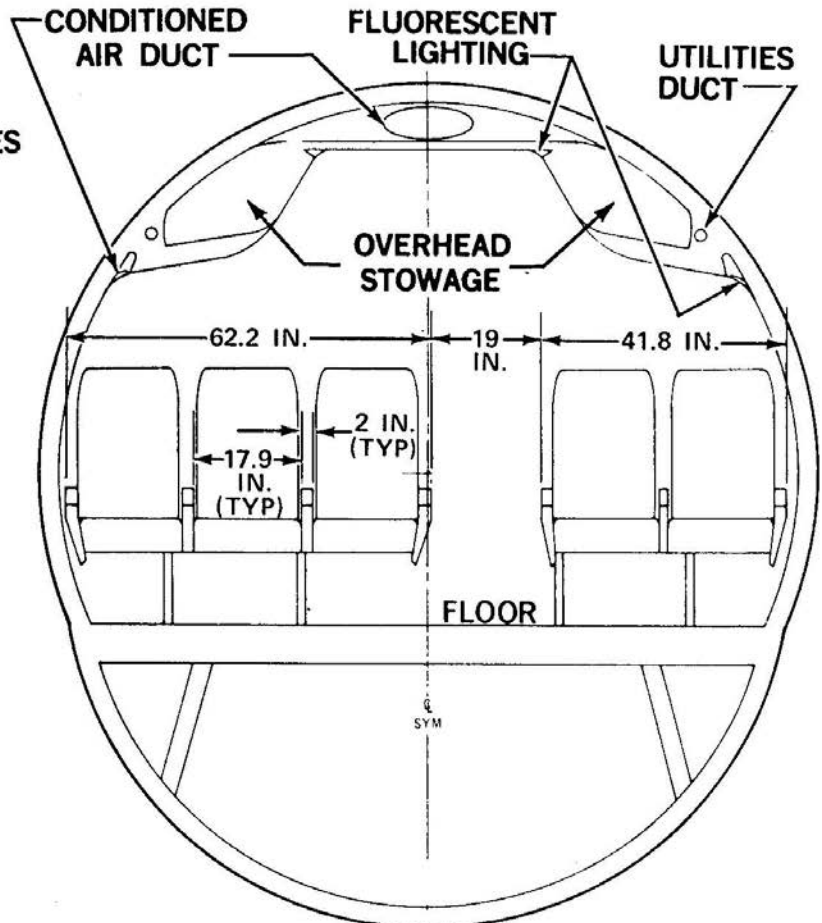

SEATING 5 ABREAST

DC-9 Series Cargo Compartments

StartupBoeing

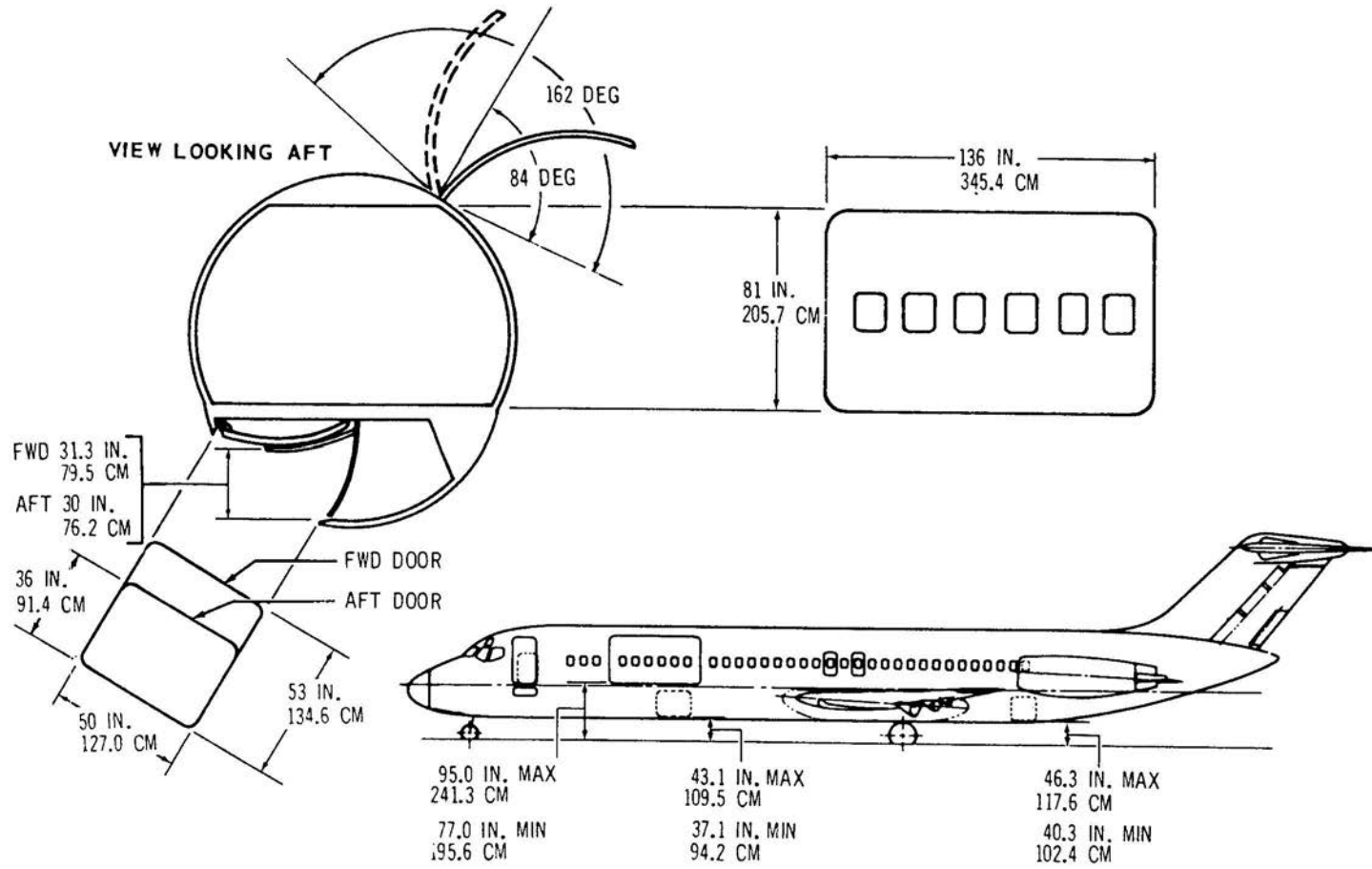

DC-9 Series Cargo Volumes

StartupBoeing

Lower cargo compartment bulk volume (with no supplemental fuel tanks*):

<u>Aircraft</u>		<u>DC-9-10</u>	<u>DC-9-20</u>	<u>DC-9-30</u>	<u>DC-9-40</u>	<u>DC-9-50*</u>
Fwd Compartment	(ft³)	373	373	562	624	577
Aft compartment	(ft³)	227	227	333	395	457
	Total	600	600	895	1,019	1,034

Main deck cargo compartment volume (88 x 108 inch pallet)

<u>Aircraft</u>		<u>DC-9-10</u>	<u>DC-9-30</u>
Multi Change (MC)	(ft³)	2,178	—
Rapid Change(RC)/Convertible Freighter(CF)	(ft³)	2,160	2,880
All Freighter (AF)	(ft³)	2,396	3,303

*DC-9-50 series equipped with forward compartment 580 Gallon supplemental fuel tank as standard. Cargo volume has been modified accordingly.

DC-9 Fuel Arrangement

StartupBoeing

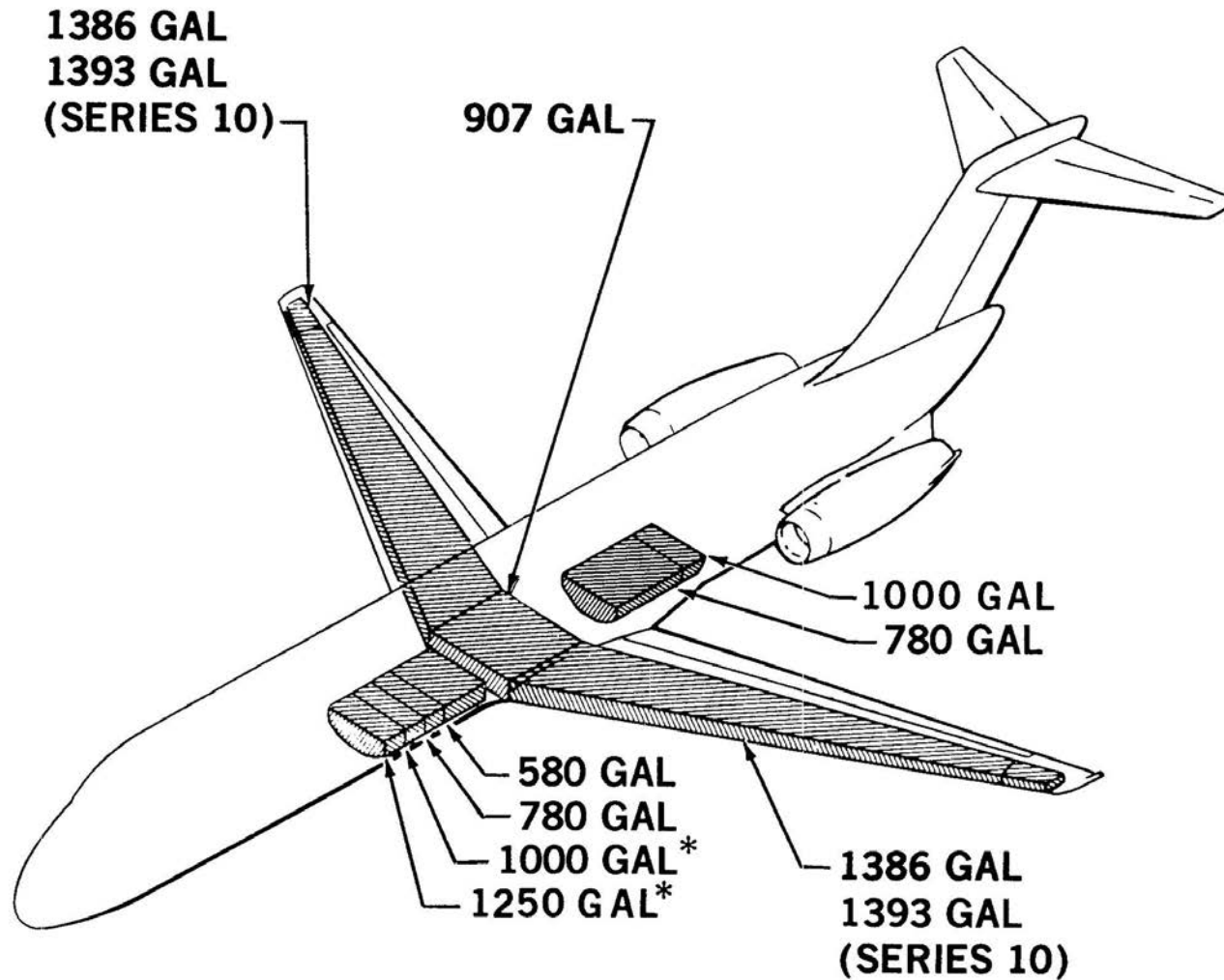

* NOT SERIES 10/20

DC-9 Series Airplane Characteristics

StartupBoeing

		MODEL DC-9-15	MODEL DC-9-15F	MODEL DC-9-21	MODEL DC-9-32	MODEL DC-9-33F	MODEL DC-9-41	MODEL DC-9-51
MAXIMUM RAMP WEIGHT	POUNDS	91,500	91,500	101,000	109,000	109,000	115,000	122,000
	KILOGRAMS	41,504	41,504	45,813	49,442	49,442	52,163	55,338
MAXIMUM LANDING WEIGHT	POUNDS	81,700	81,700	95,300	99,000	99,000	102,000	110,000
	KILOGRAMS	37,059	37,059	43,227	44,906	44,906	46,266	49,895
MAXIMUM TAKEOFF WEIGHT	POUNDS	90,700	90,700	98,000	108,000	108,000	114,000	121,000
	KILOGRAMS	41,141	41,141	45,359	48,988	48,988	51,710	54,885
OPERATING WEIGHT EMPTY	POUNDS	49,162	53,200	52,644	56,855	56,430	61,335	64,675
	KILOGRAMS	22,300	24,131	23,879	25,789	25,596	27,821	29,336
ZERO FUEL WEIGHT	POUNDS	74,000	74,000	84,000	87,000	90,000	93,000	98,500
	KILOGRAMS	33,566	33,566	38,102	39,463	40,823	42,184	44,679
MAXIMUM STRUCTURAL PAYLOAD	POUNDS	24,838	20,800	25,356	30,145	13,530	31,665	33,825
	KILOGRAMS	11,266	9,435	11,501	13,674	6,137	14,363	15,343
MAXIMUM SEATING CAPACITY	PASSENGERS	90	—	90	115	—	125	135
MAXIMUM CARGO VOLUME	CUBIC FEET	600	2,762	600	895	4,195	1,019	1,174
	CUBIC METERS	17.0	78.2	17.0	25.3	119.0	28.9	33.2
USABLE FUEL CAPACITY	U.S. GALLONS	3,693	3,699	3,679	3,679	3,679	3,679	3,679
	LITERS	13,979	13,926	13,926	13,926	13,926	13,926	13,926
	POUNDS	24,743	24,649	24,649	24,649	24,649	24,649	24,649
	KILOGRAMS	11,223	11,181	11,181	11,181	11,181	11,181	11,181

DC-9 Series Engine Characteristics

StartupBoeing

JT8D PERFORMANCE

	JT8D-1/ -1A	JT8D-7/ -7A	JT8D-9/ -9A	JT8D-11	JT8D-15	JT8D-17
Rating	14,000 lb to 59°F	14,000 lb to 84°F	14,500 lb to 84°F	15,000 lb to 84°F	15,500 lb to 84°F	16,000 lb to 84°F
TIT (Estimated) °F		1852	1860	1930	2005	2087
Redline EGT °F (°C)	1058/1076 (570/580)	1058/1076 (570/580)	1076/1094 (580/590)	1103 (595)	1148 (620)	1202 (650)
Redline Rotor Speeds						
(N1 - N1) RPM	8,600 — 12,250	8,600 — 12,250	8,600 — 12,250	8,600 — 12,250	8,800 — 12,250	8,800 — 12,250
Airflow lb/sec	315	315	318	321	324	324
Bypass ratio	1.10	1.10	1.03	1.01	0.99	1.01
Compressor pressure ratio	16.2	16.2	16.9	17.5	18.0	16.9
Fan pressure ratio	1.88	1.88	1.91	1.94	1.975	2.01
Weight lb	3155	3205	3252	3309	3309	3330

DC-9-15 Payload-Range

StartupBoeing

NOTE: DOMESTIC RESERVES AT
200 NAUTICAL MILES ALTERNATE
PLUS 45 MINUTES AT LRC

- STANDARD DAY
- NO WIND
- OEW = 49,162 POUNDS
- JT8D - 1 ENGINE

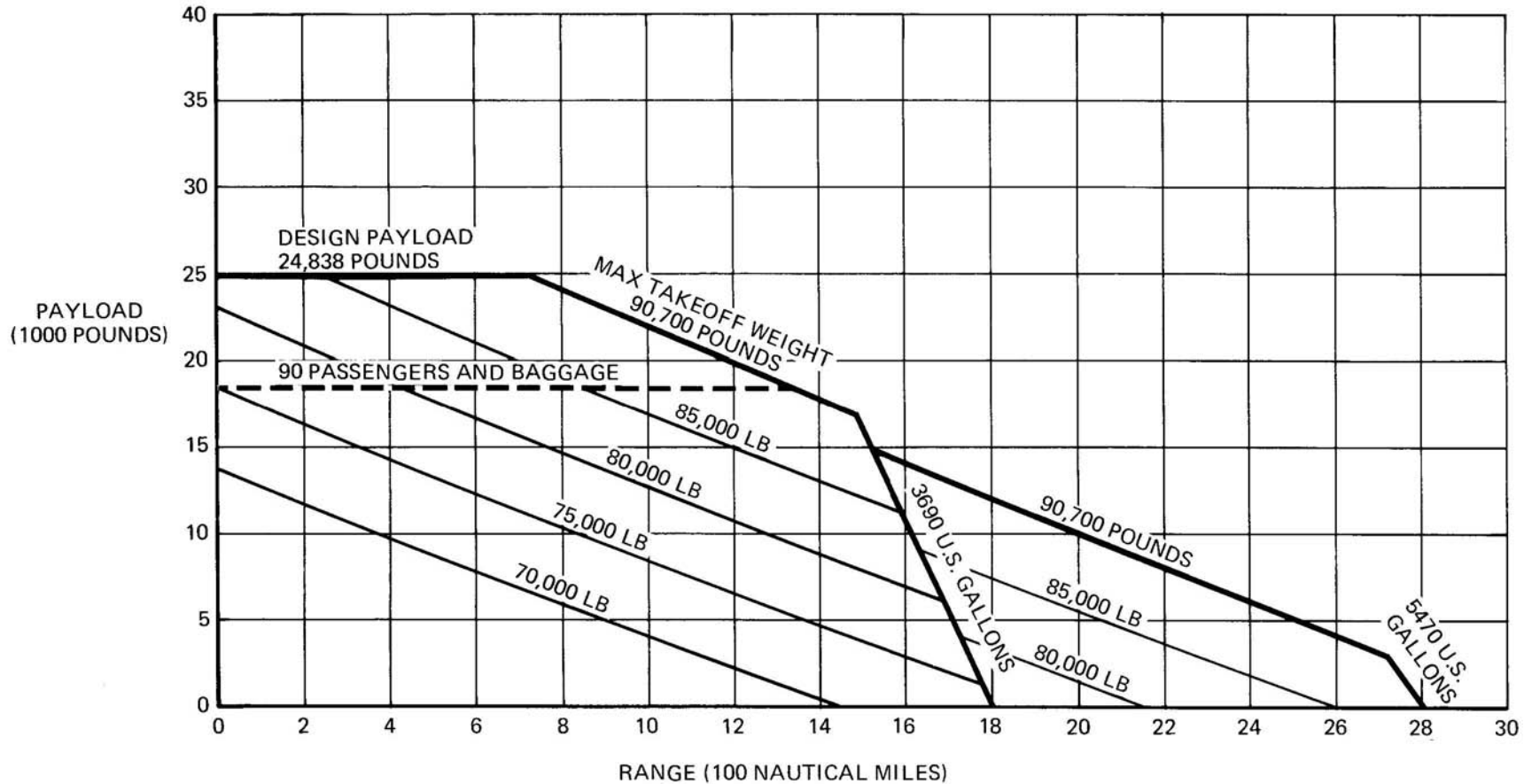

DC-9-21 Payload-Range

StartupBoeing

NOTE: DOMESTIC RESERVES AT
200 NAUTICAL MILES ALTERNATE
PLUS 45 MINUTES AT LRC

- STANDARD, DAY
- NO WIND
- OEW = 52,644 POUNDS
- JT8D – 11 ENGINES

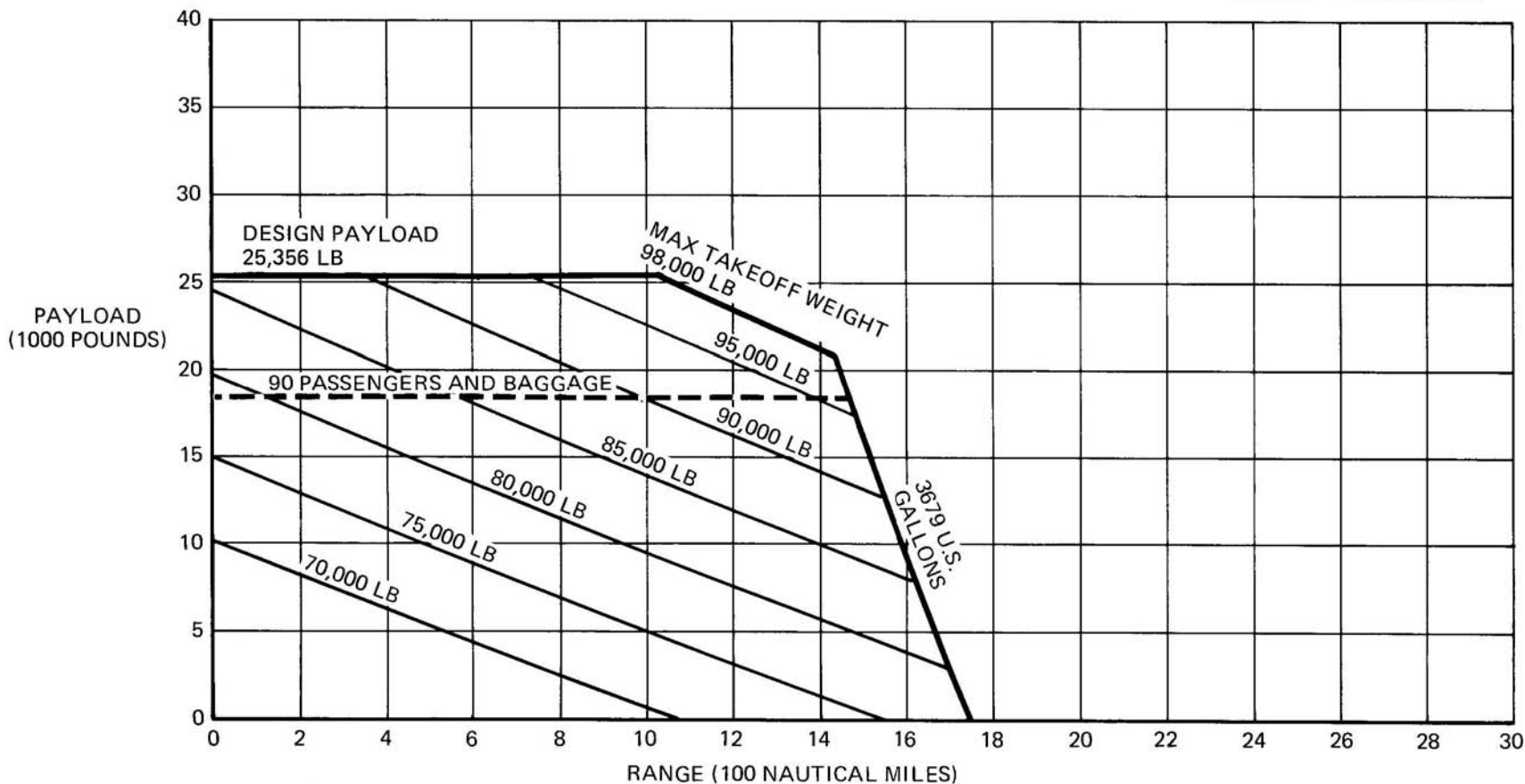

DC-9-32 Payload-Range

StartupBoeing

NOTE: DOMESTIC RESERVES AT
200 NAUTICAL MILES ALTERNATE
PLUS 45 MINUTES AT LRC

- STANDARD DAY
- NO WIND
- OEW = 56,855 POUNDS
- JT8D – 7 ENGINES

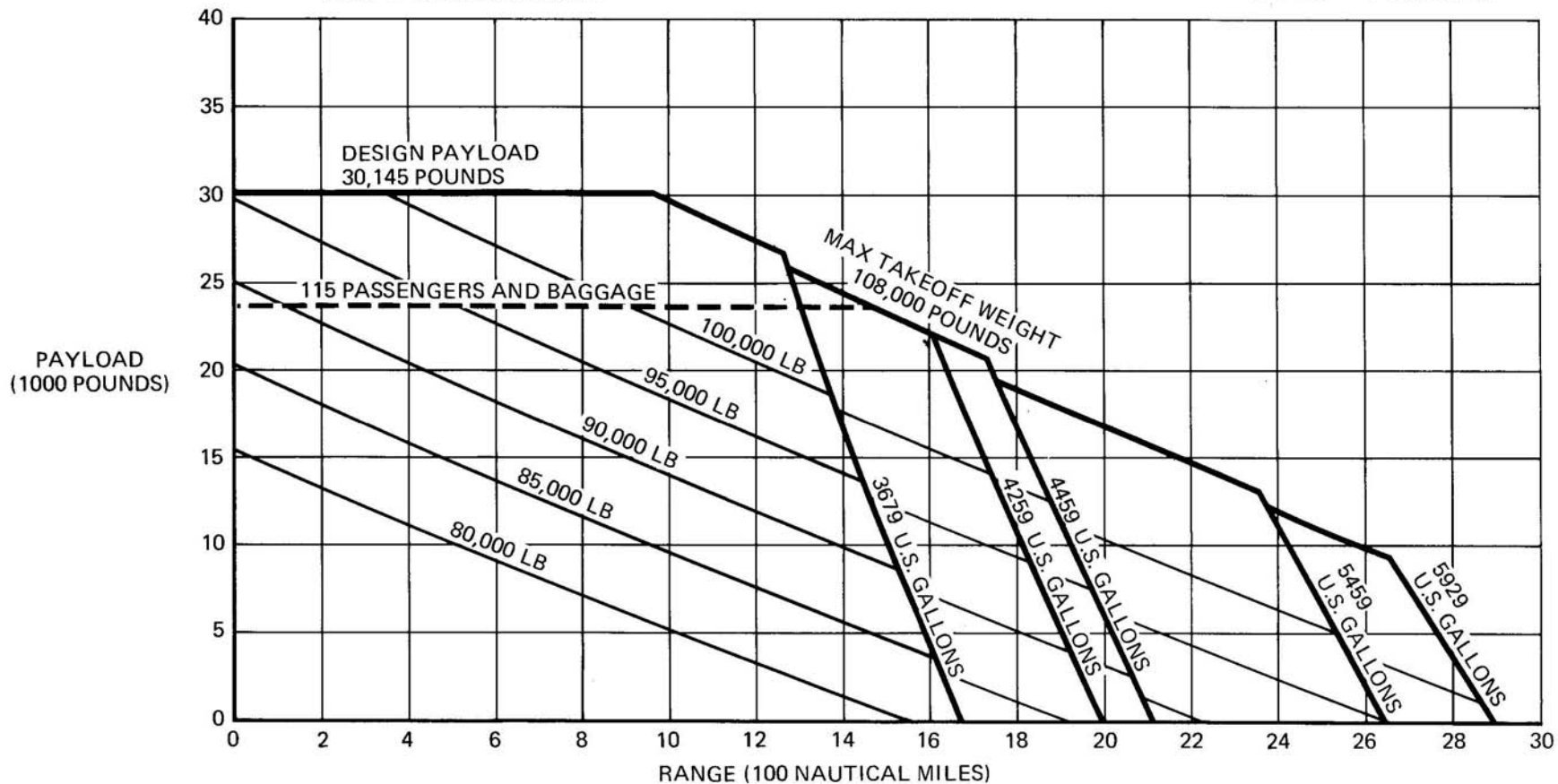

DC-9-41 Payload-Range

StartupBoeing

NOTE: DOMESTIC RESERVES AT
200 NAUTICAL MILES ALTERNATE
PLUS 45 MINUTES AT LRC

- STANDARD DAY
- NO WIND
- OEW = 61,335 POUNDS
- JT8D – 15 ENGINES

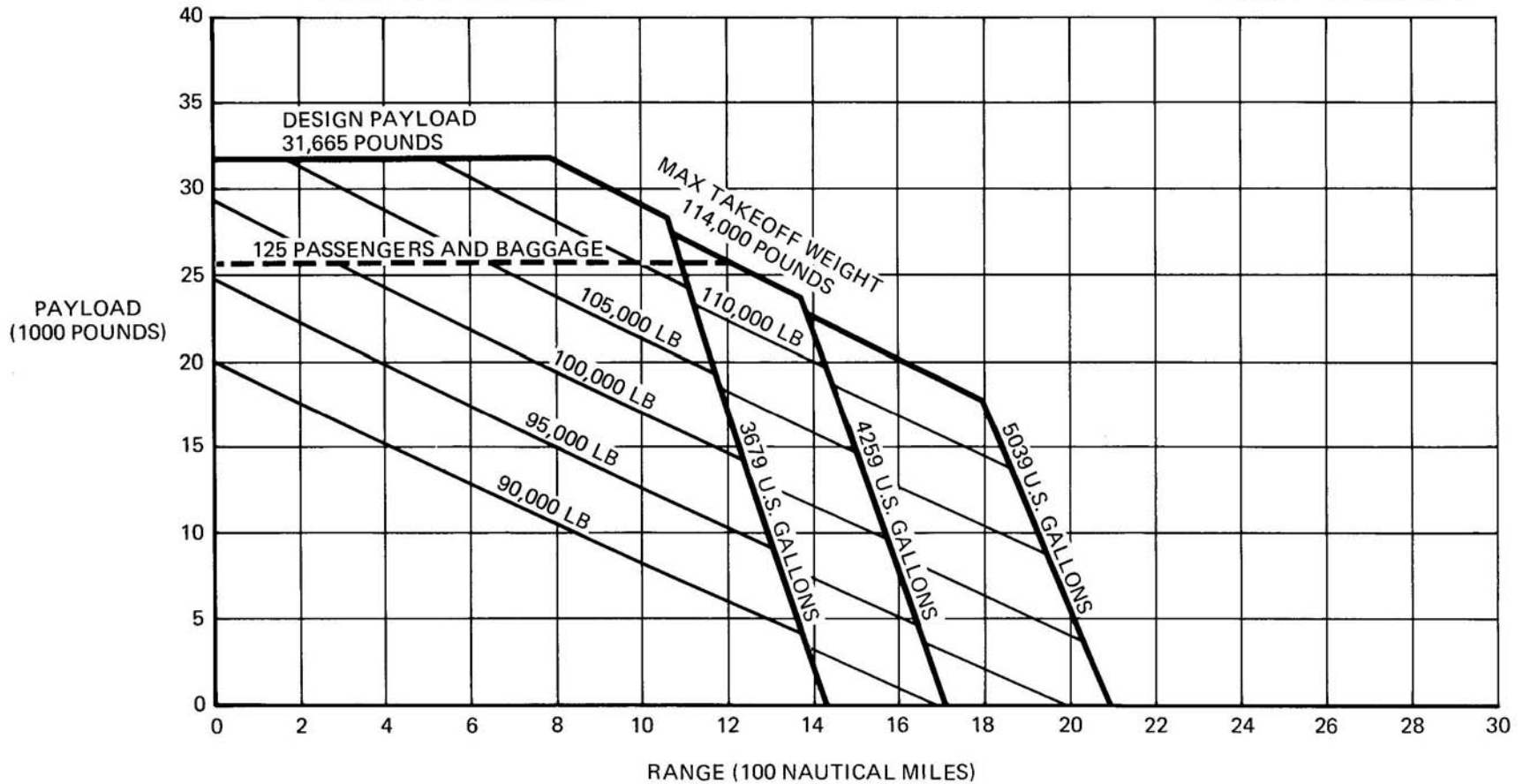

DC-9-51 Payload-Range

StartupBoeing

NOTE: DOMESTIC RESERVES AT
200 NAUTICAL MILES ALTERNATE
PLUS 45 MINUTES AT LRC

- STANDARD DAY
- NO WIND
- OEW = 64,675 POUNDS
- JT8D – 17 ENGINES

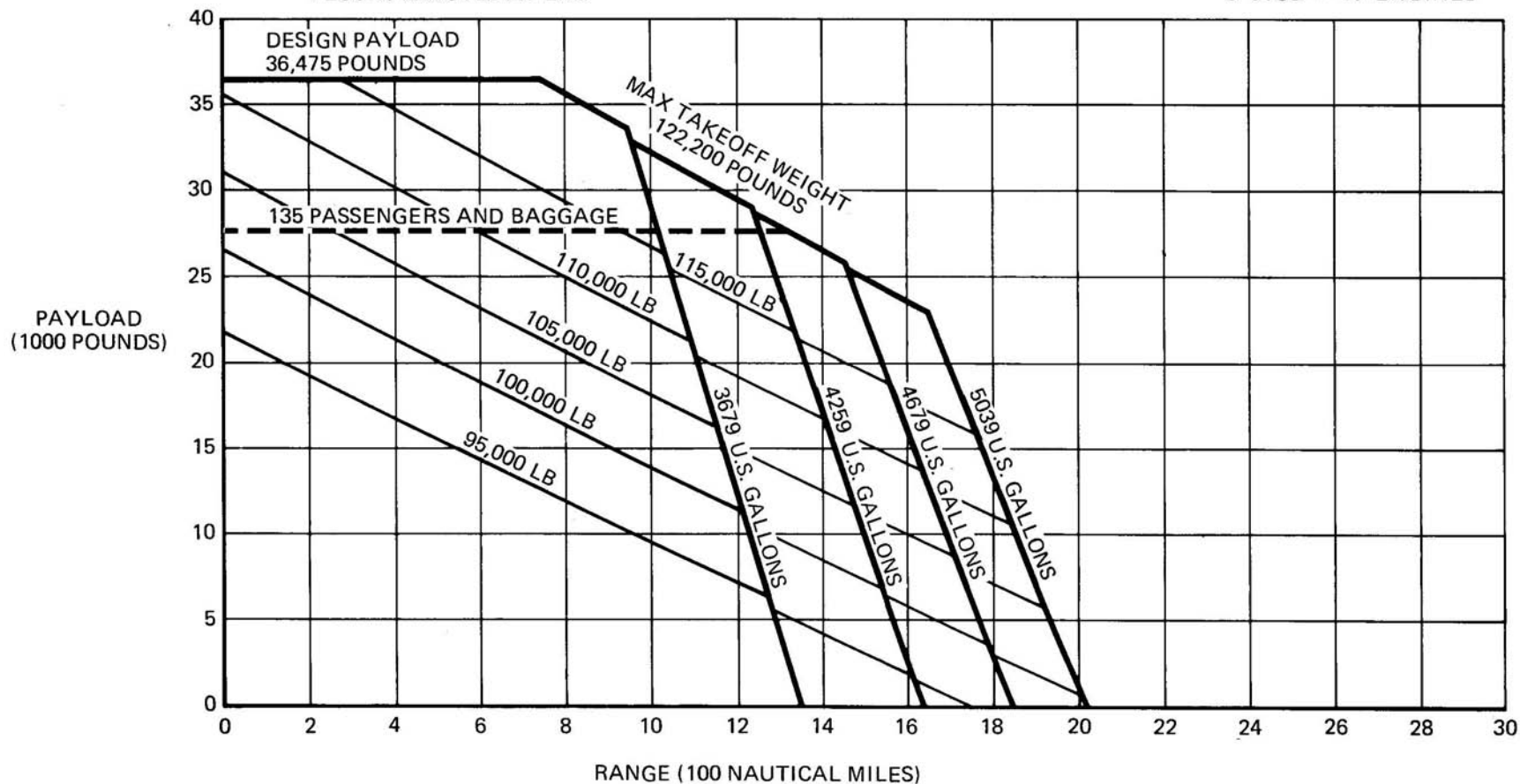

DC-9 Flight Deck

StartupBoeing

