

MD-11

StartupBoeing

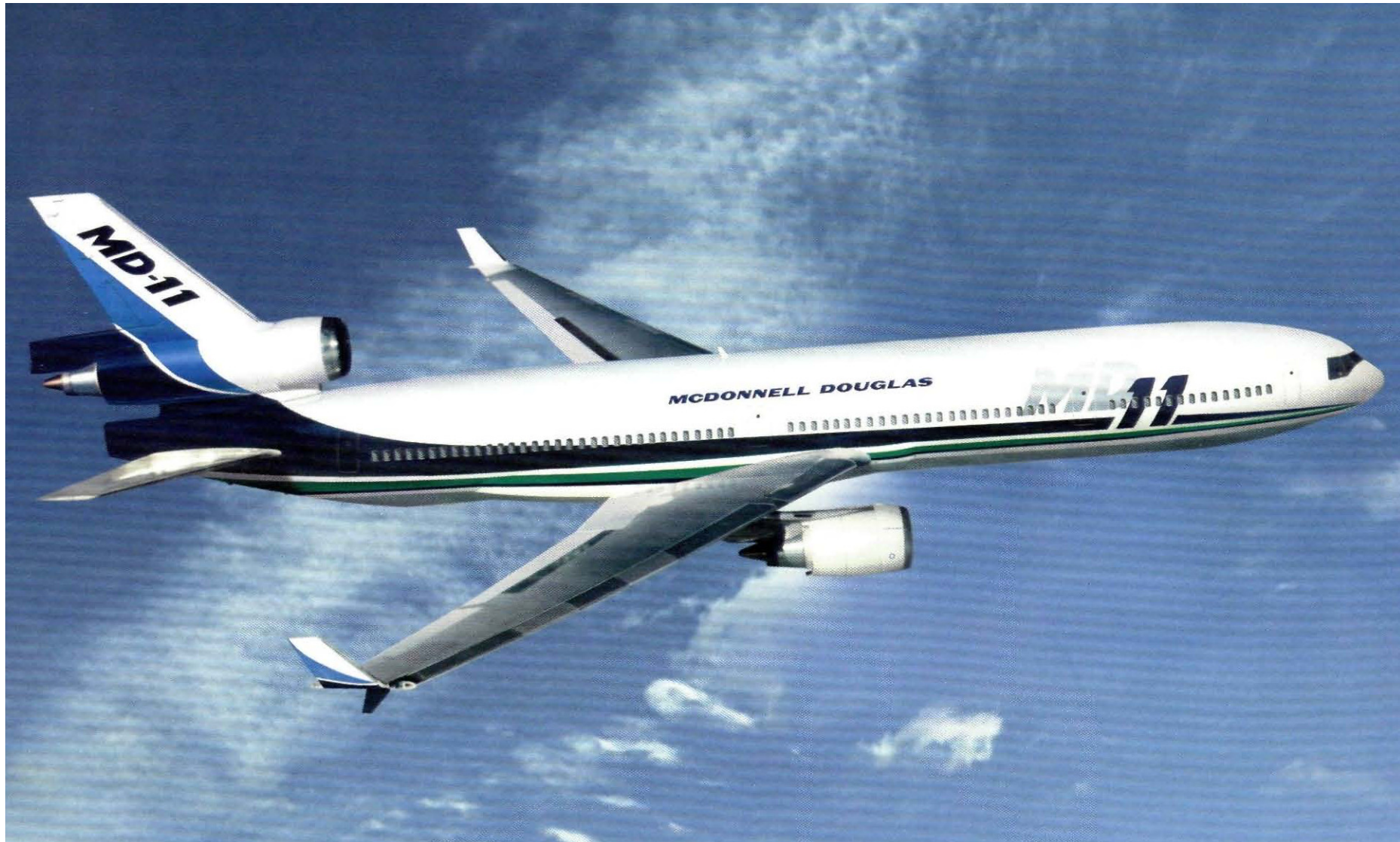

MD-11

StartupBoeing



MD-11

StartupBoeing



MD-11

StartupBoeing



MD-11 General Arrangement

StartupBoeing

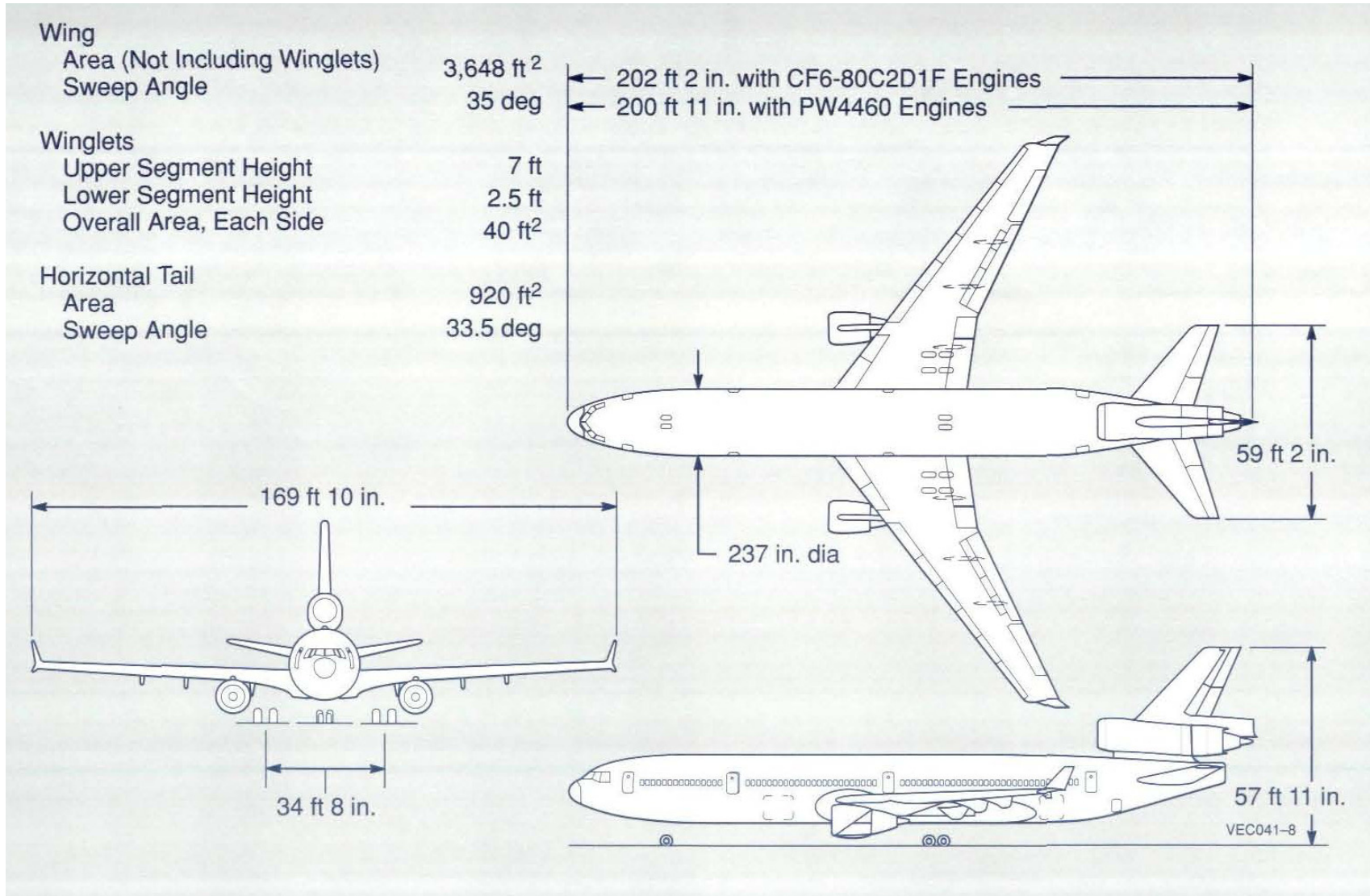

MD-11 Ground Service Equipment Arrangement

StartupBoeing

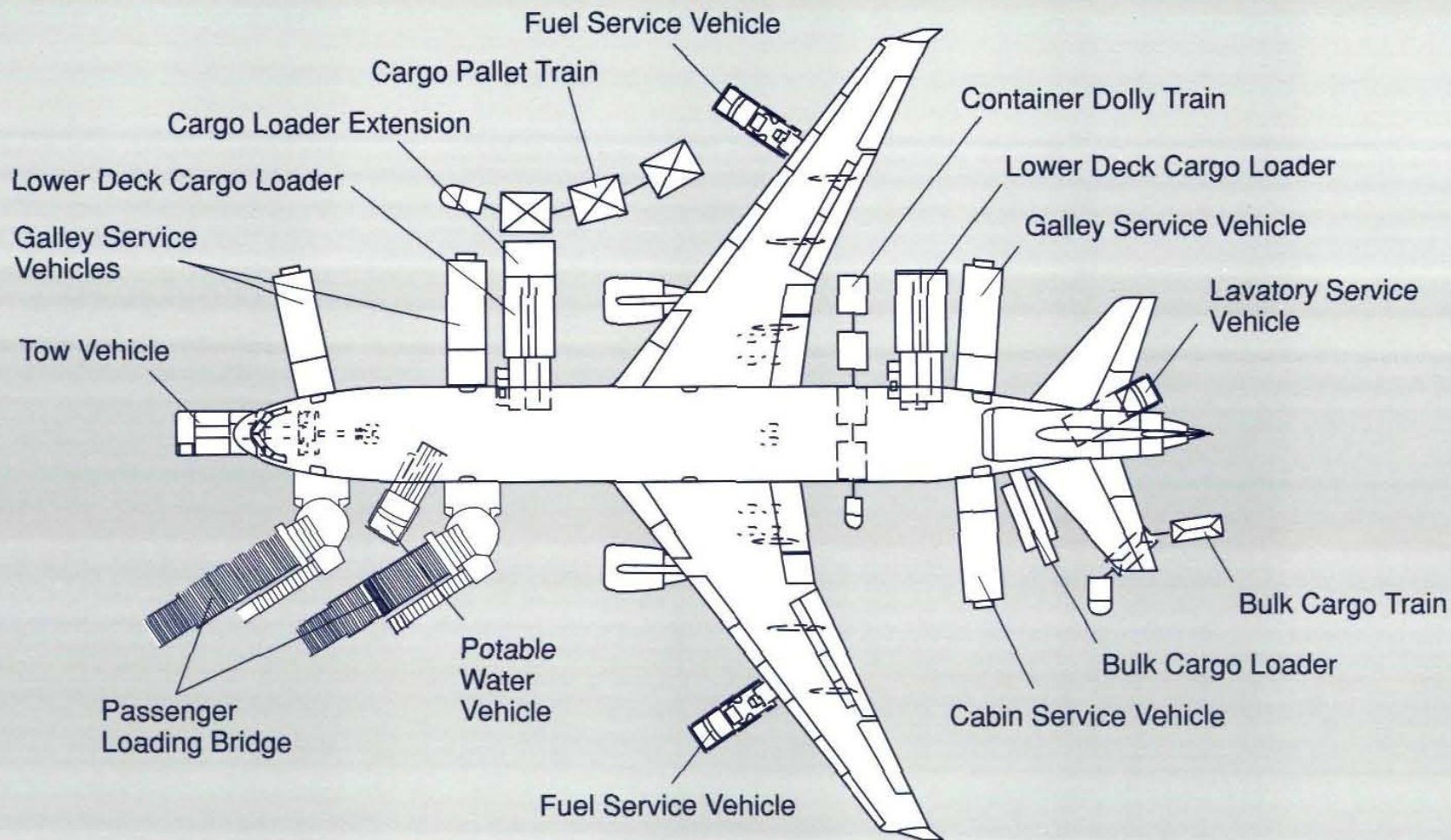

Note: The Aircraft Auxiliary Power Unit Supplies Electrical, Pneumatic Air, and Preconditioned Air.

VEC041-104

MD-11 Service Connections

StartupBoeing

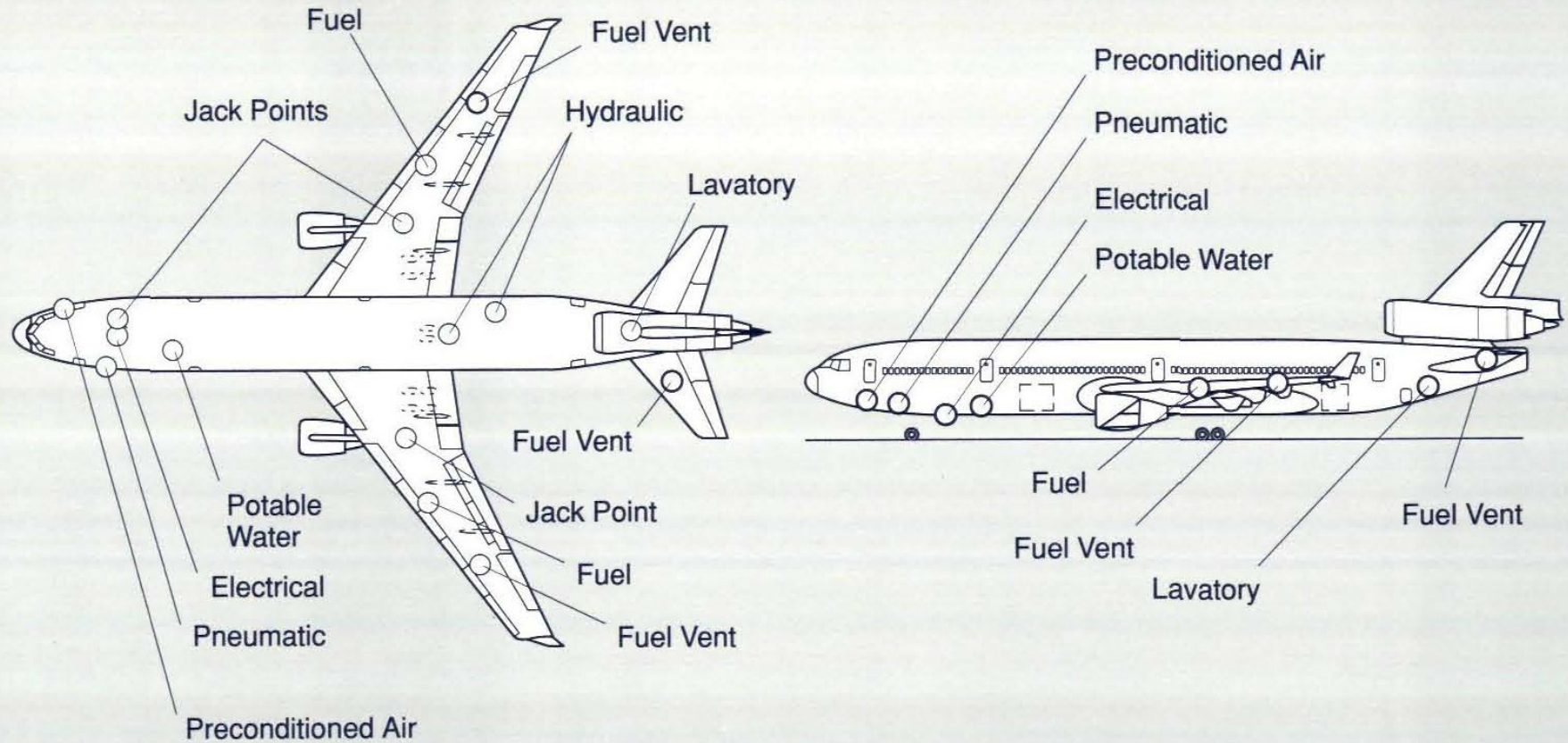

MD-11 Family

StartupBoeing

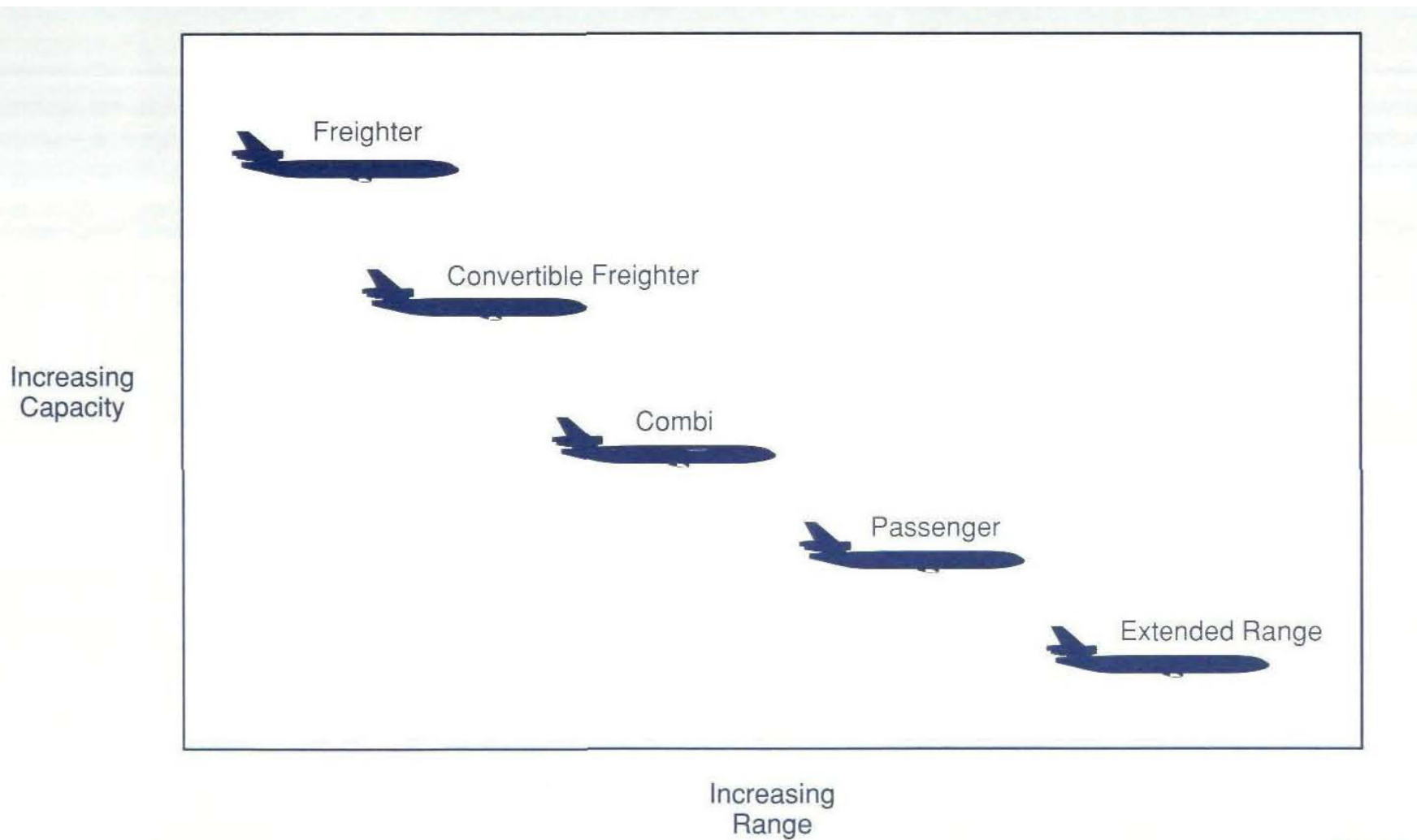

MD-11 Typical Interior Arrangement

StartupBoeing

THREE-CLASS INTERIORS

298 Passengers (Standard)

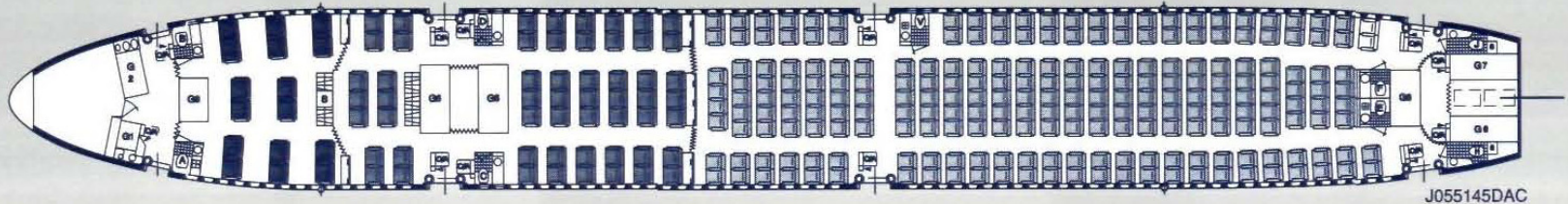

First	16 Seats, 60-in. Pitch
Business	56 Seats, 38-in. Pitch
Economy	226 Seats, 32-in. Pitch (2-5-2)

298 Passengers (Option)

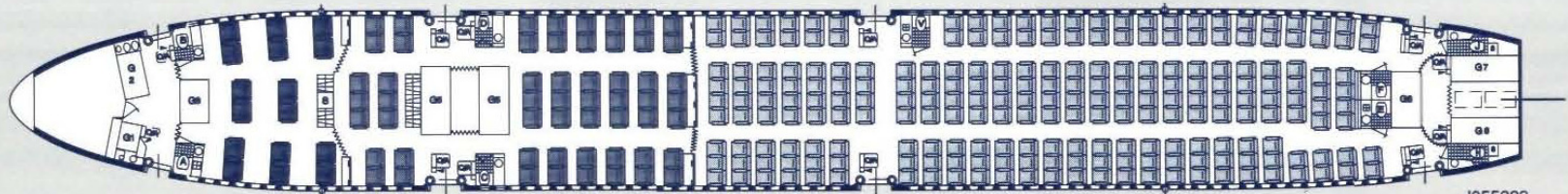

First	16 Seats, 60-in. Pitch
Business	56 Seats, 38-in. Pitch
Economy	226 Seats, 32-in. Pitch (3-4-2)

MD-11 Combi Features

StartupBoeing

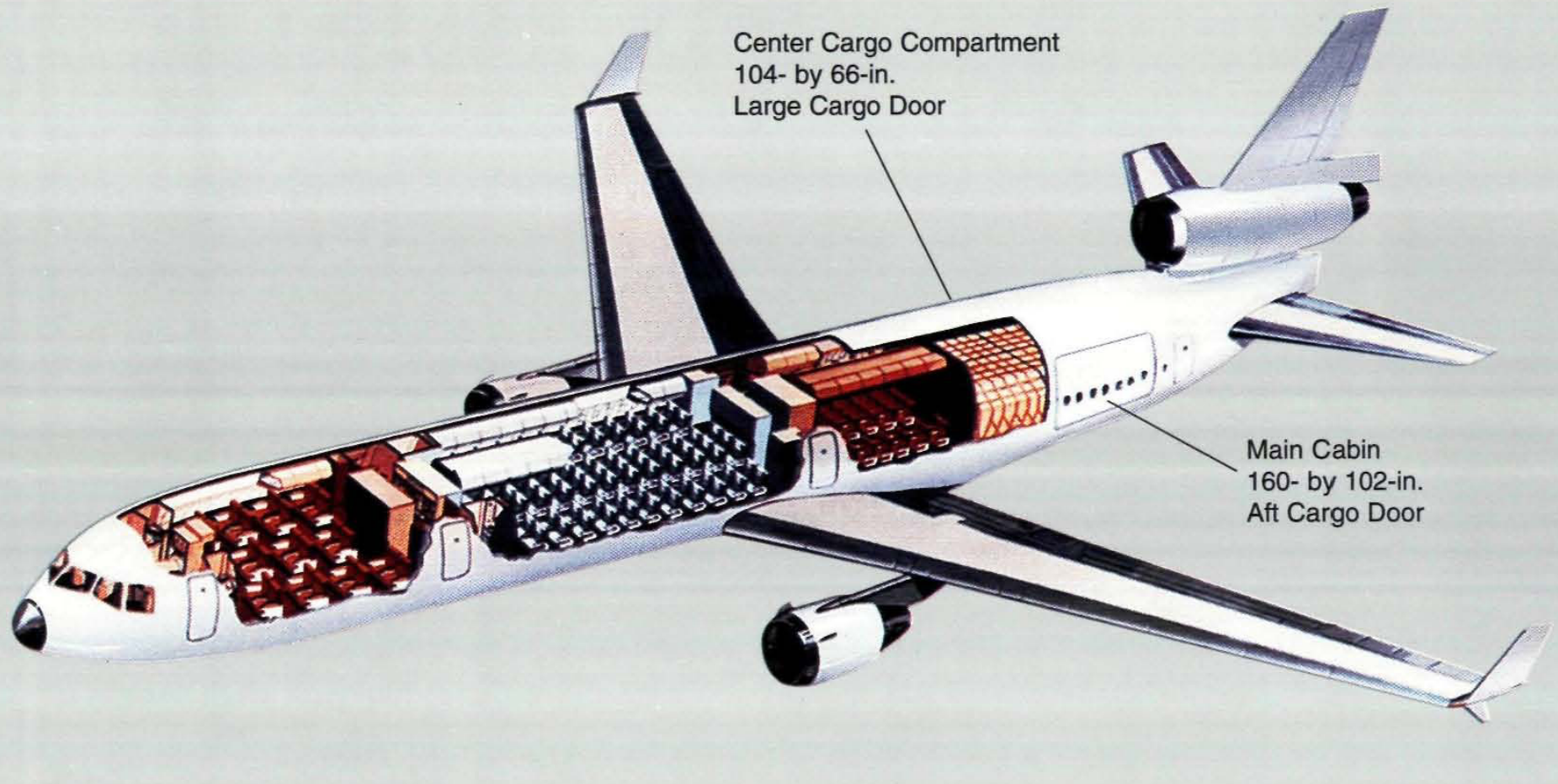

MD-11 Combi Typical Interior Arrangement

StartupBoeing

COMBI INTERIOR ARRANGEMENTS

Standard

214 Seats + 6 Pallets — Two Class



First Class
Economy

34 Seats
180 Seats

214 Seats

41/42-in. Pitch
34-in. Pitch

Option

181 Seats + 6 Pallets — Three Class

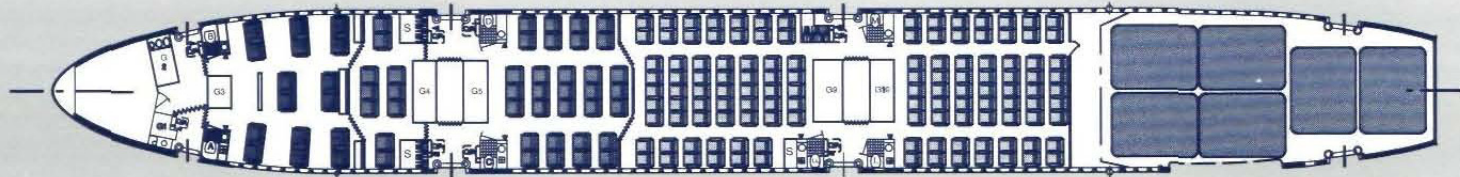

First Class
Business Class
Economy

16 Seats
41 Seats
124 Seats

181 Seats

62-in. Pitch
38-in. Pitch
34-in. Pitch

MD-11 Combi Interior Arrangements

StartupBoeing

COMBI FLEXIBILITY – FIVE CONFIGURATIONS

One-Day Conversion Time

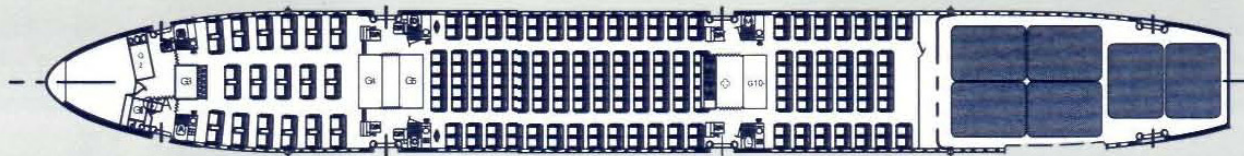

Standard 6-Pallet

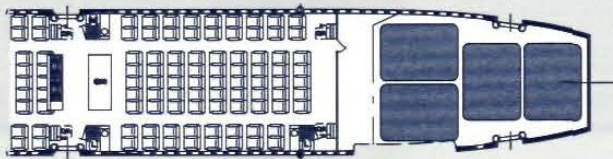

4-Pallet

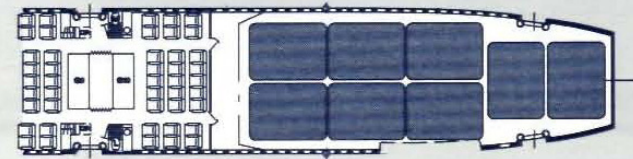

8-Pallet

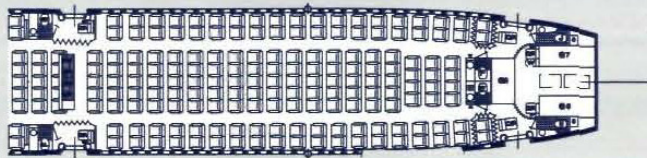

All-Passenger

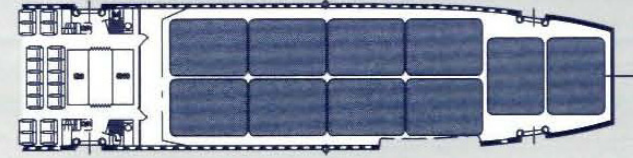

10-Pallet

Provisions and Kit for Conversion to

MD-11 Convertible Freighter Features

StartupBoeing

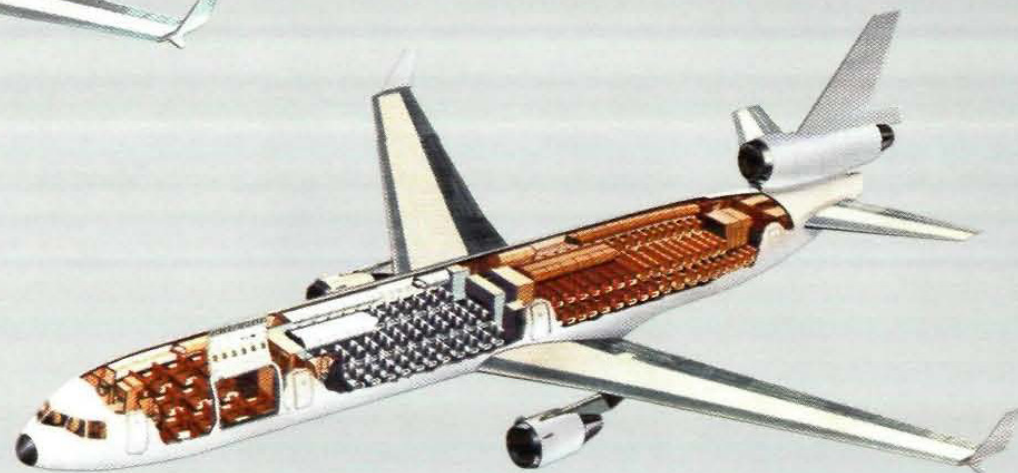

VEC041-127

MD-11 Convertible Interior Arrangement

StartupBoeing

CONVERTIBLE FREIGHTER INTERIOR ARRANGEMENTS

Three-Class – 298 Passengers

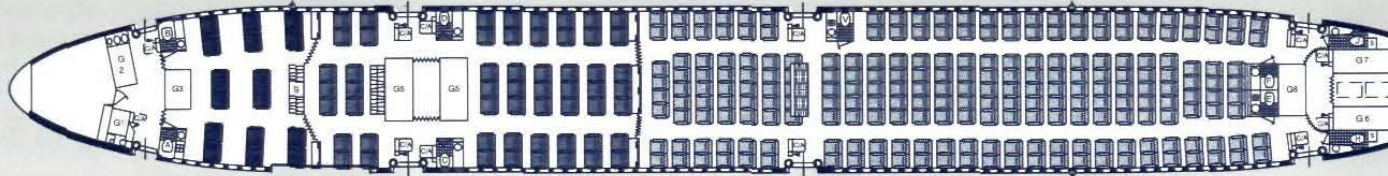

First Class	16 Seats	60-in. Pitch
Business Class	56 Seats	38-in. Pitch
Economy	226 Seats	32-in. Pitch
	<u>298 Seats</u>	

26 Main Deck Cargo Pallets

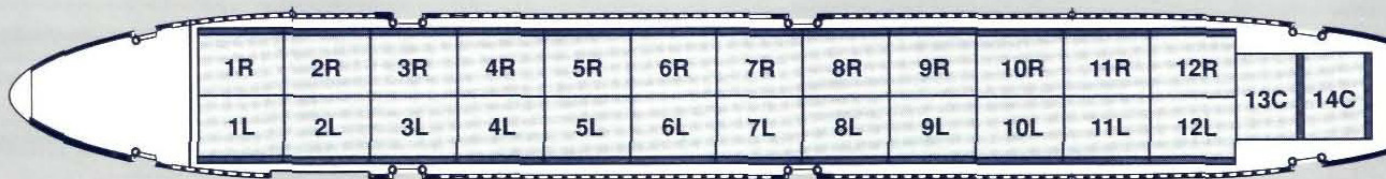

- (26) 88- by 125-in. Pallets = 13,521 ft³
- (26) 96- by 125-in. Pallets = 14,508 ft³

MD-11 Seating Flexibility

StartupBoeing

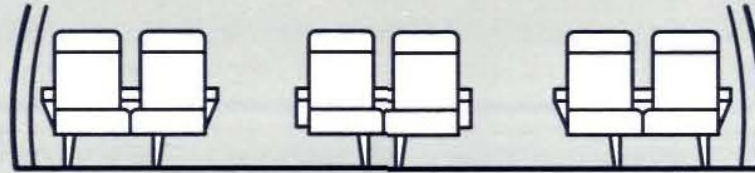

6 Abreast

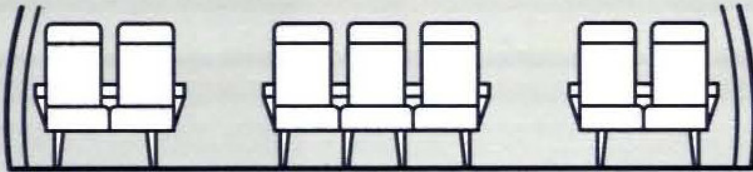

7 Abreast

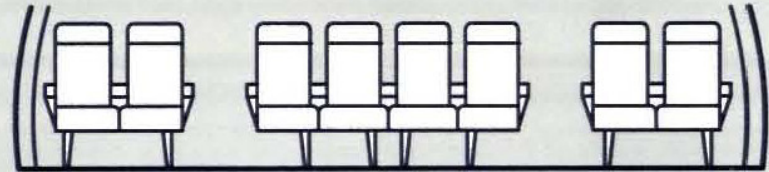

8 Abreast

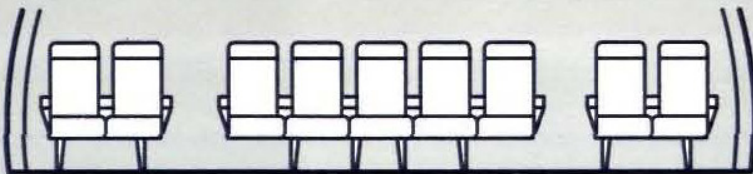

9 Abreast

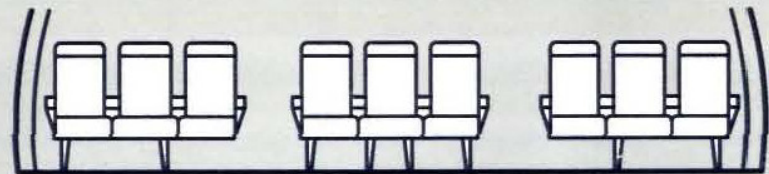

9 Abreast

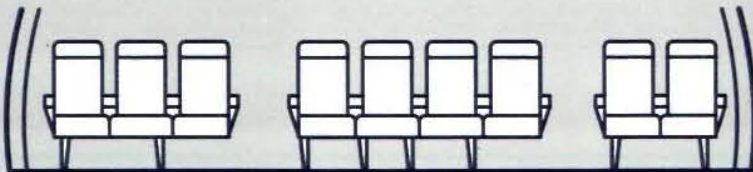

9 Abreast

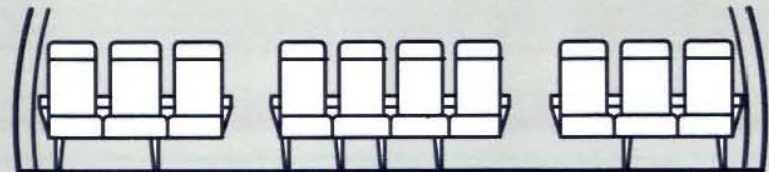

10 Abreast

MD-11 Seating

StartupBoeing



MD-11 Lower Hold Cargo Capacity

StartupBoeing

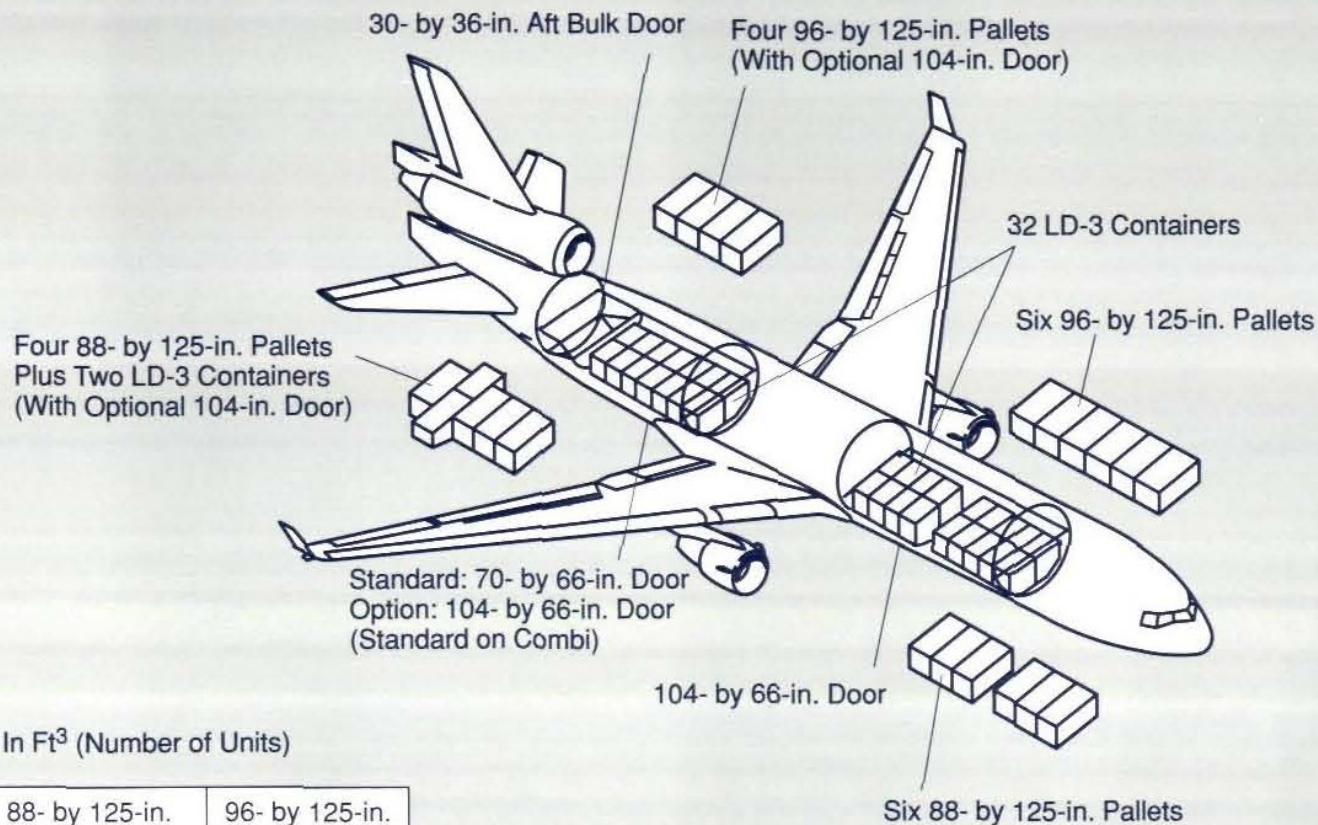

Cargo Volumes Shown In Ft³ (Number of Units)

	LD-3	88- by 125-in.	96- by 125-in.
Fwd	2,844 (18)	2,232 (6)	2,442 (6)
Center	2,212 (14)	1,804 (4)*	1,628 (4)
Aft Bulk	510	510	510
Total Volume	5,566	4,546	4,580

* Four plus Two LD-3 Containers

MD-11 Lower Hold Cargo Capability

StartupBoeing

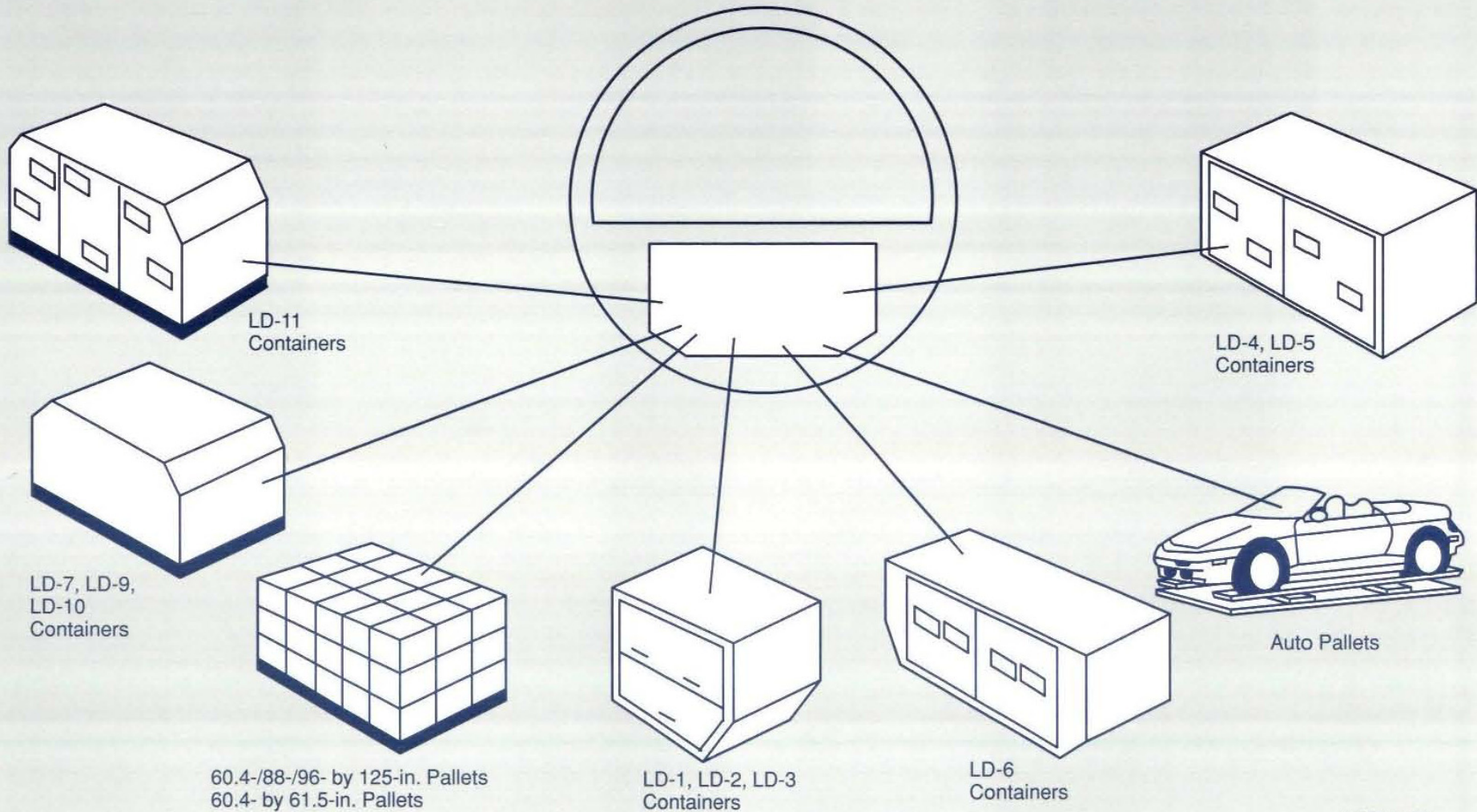

VEC041-50



MD-11 Aft Cargo Hold

StartupBoeing



MD-11 Operating Characteristics

StartupBoeing

		 GE	 P&W
MRW	(lb)	633,500	633,500
MTOGW	(lb)	630,500 *	630,500 *
MZFW	(lb)	400,000	400,000
MLW	(lb)	430,000	430,000
OEW	(lb)	286,170	287,770
Fuel Capacity	(lb)	258,721	258,721
Passenger Capacity, 3-Class		298	298
Range With 298 Passengers and Bags			
Standard Engine	(n mi)	6,725	6,705
Optional Fuel		7,130	7,090

*Optional Weight

MD-11 Extended Range Characteristics

StartupBoeing

MRW	(lb)	633,500
MTOGW	(lb)	630,500
MZFW	(lb)	400,000
MLW	(lb)	430,000
OEW (GE Engines)	(lb)	288,658
Fuel Capacity Includes 3,000-Gal Auxiliary Fuel Tank	(lb)	278,821
Passenger Capacity, 3-Class		298
Range With 298 Passengers and Bags	(n mi)	7,130

MD-11 Combi Operating Characteristics

StartupBoeing

MRW	(lb)	633,500
MTOGW	(lb)	630,500 *
MZFW	(lb)	430,000 *
MLW	(lb)	458,000 *
OEW (GE Engines)	(lb)	286,051
Fuel Capacity	(lb)	258,721
Passenger Capacity, 2-Class		214
Space-Limited Payload	(lb)	116,947 **
Range, Space-Limited Payload	(n mi)	5,356

*Optional Weights

**Six-Pallet Main-Deck Configuration

MD-11 Convertible Freighter Characteristics

StartupBoeing

MRW	(lb)	633,500
MTOGW	(lb)	630,500
MZFW	(lb)	451,300*
MLW	(lb)	481,500*
Fuel Capacity	(lb)	258,721

Freighter Configuration

OEW (GE Engines, With Tare)	(lb)	264,429
Cargo Volume		
Main Deck, 26 96- by 125-in. Pallets	(ft ³)	14,480
Lower Deck	(ft ³)	5,164
Total	(ft ³)	19,644
Payload		
Space-Limited at 8.5 lb/ft ³	(lb)	166,974
Gross-Weight-Limited	(lb)	197,773
Range		
Space-Limited Payload	(n mi)	4,463
Weight-Limited Payload	(n mi)	3,865

Passenger Configuration



OEW (GE Engines)	(lb)	289,170
Passenger Capacity, 3-Class		298
Space-Limited Payload at 8.5 lb/ft ³	(lb)	100,810
Range		
298 Passengers and Bags	(n mi)	6,683
Space-Limited Payload	(n mi)	5,790

*Optional Weights

VEC041-128

MD-11 Engines

StartupBoeing

		 CF6-80C2D1F CF6-80C2D2F	 PW4460 PW4462
Thrust Ratings			
■ SLS Ideal Takeoff	(lb _f)	61,500	60,000
■ Optional Takeoff	(lb _f)	63,500	62,000
■ Max Cruise 35,000 ft, Mach 0.82	(lb _f)	11,000	11,400
■ Max Climb 15,000 ft, 330 KCAS, ISA	(lb _f)	24,900	22,200
SLS Flat Rate	(°F)	86	86
Cruise SFC	$\frac{\text{lb}}{\text{lb/hr}}$	1.76	1.69
Fan Diameter	(in.)	93.0	93.6
Length	(in.)	158.9	132.7
Dry Weight	(lb)	12,920	12,500

MD-11 Supplemental Fuel System

StartupBoeing

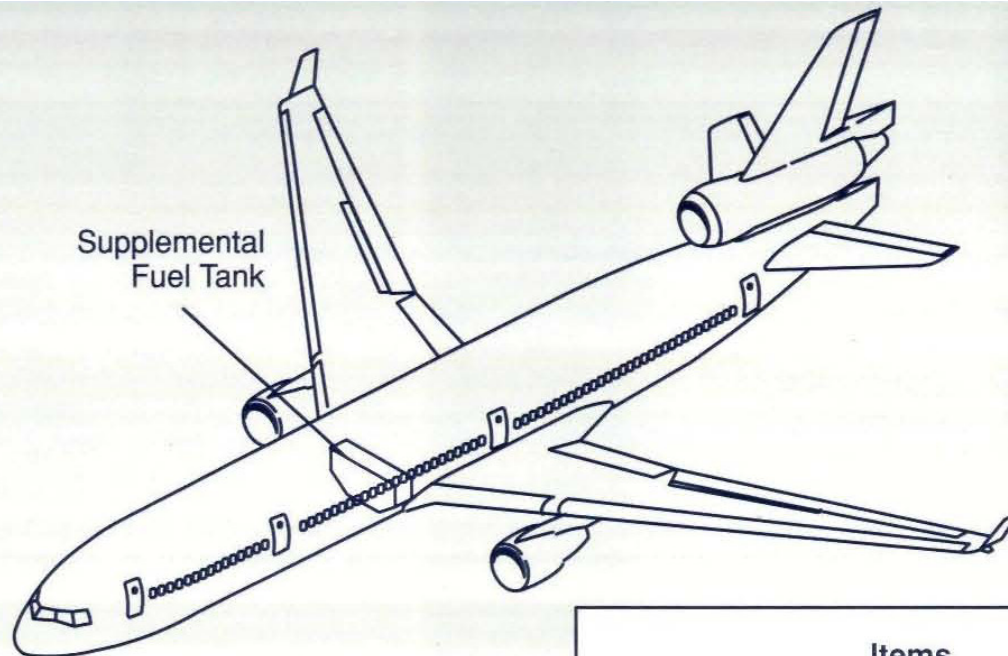

Items	Weight (lb)
Estimated Provision and Installation	836
Tank	1,885
Δ MEW (Subtotal)	2,721
Unusable Fuel	100
Δ OEW (Subtotal)	2,821
88- by 125-in. Pallet (Tare Weight) =	- 214
Δ OEW (Total)	2,607

MD-11 Auxiliary Fuel

StartupBoeing

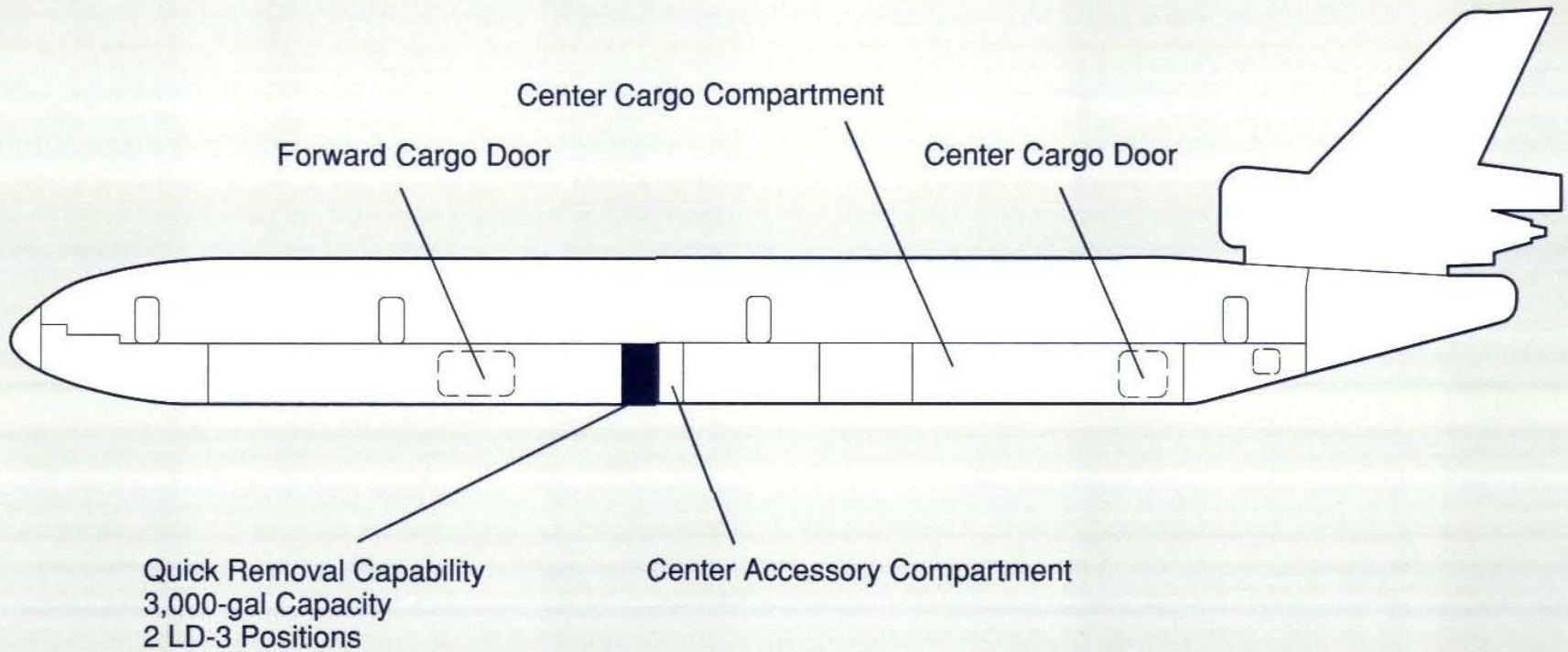

MD-11 Payload-Range Capability

StartupBoeing

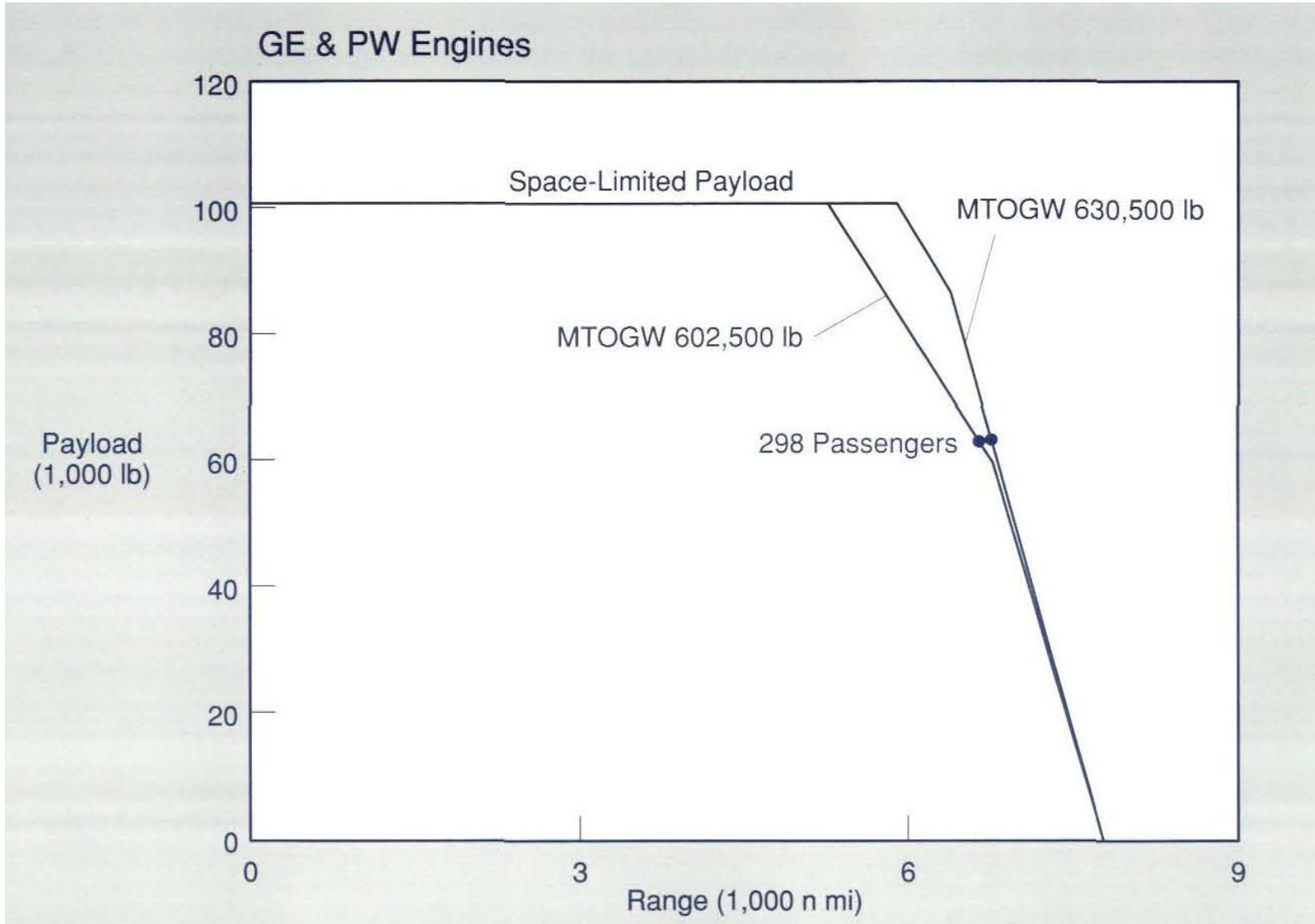

MD-11ER Payload-Range Capability

StartupBoeing

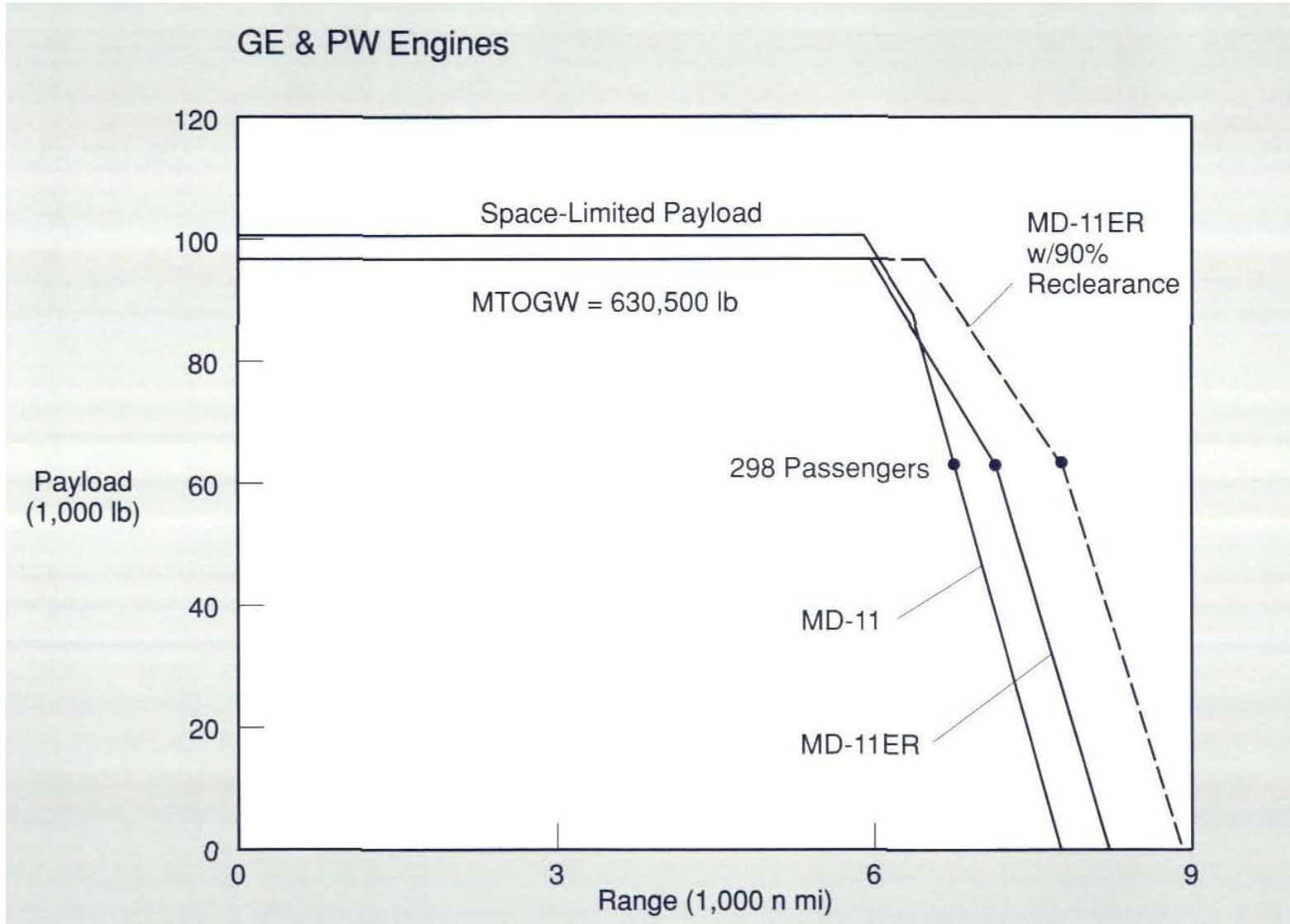

MD-11 Range Capability

StartupBoeing

From Zurich



Full Passengers and Baggage Payload
International Reserves — 150-n-mi Alternate
3% Airways Factor
85% Annual Winds

VEC041-66

MD-11 Range Capability

StartupBoeing

From Los Angeles



Full Passengers and Baggage Payload
International Reserves — 150-n-mi Alternate
3% Airways Factor
85% Annual Winds

VEC041-63

MD-11 Range Capability

StartupBoeing

From New York

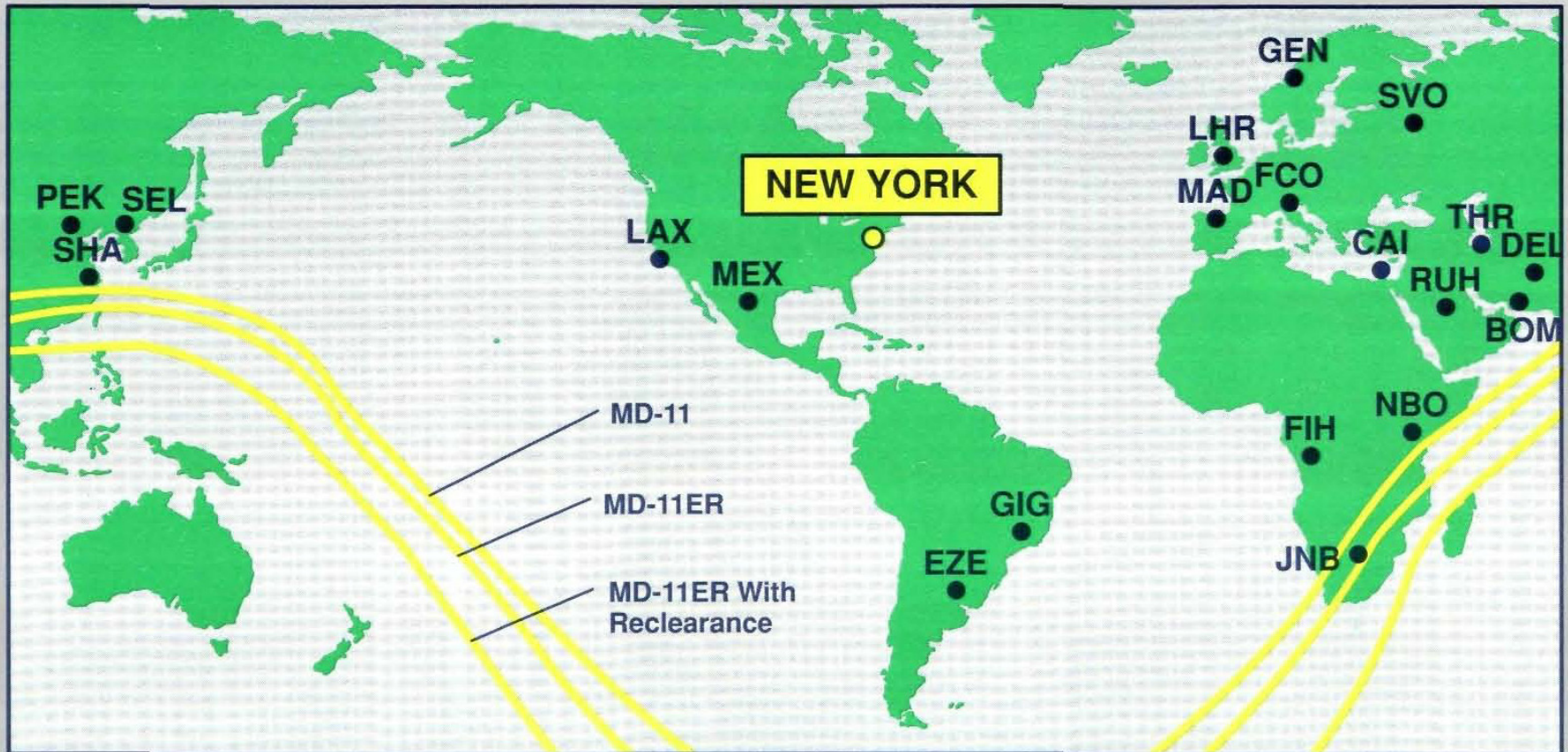

Full Passengers and Baggage Payload
International Reserves — 150-n-mi Alternate
3% Airways Factor
85% Annual Winds

VEC041-64

MD-11 Range Capability

StartupBoeing

From Tokyo

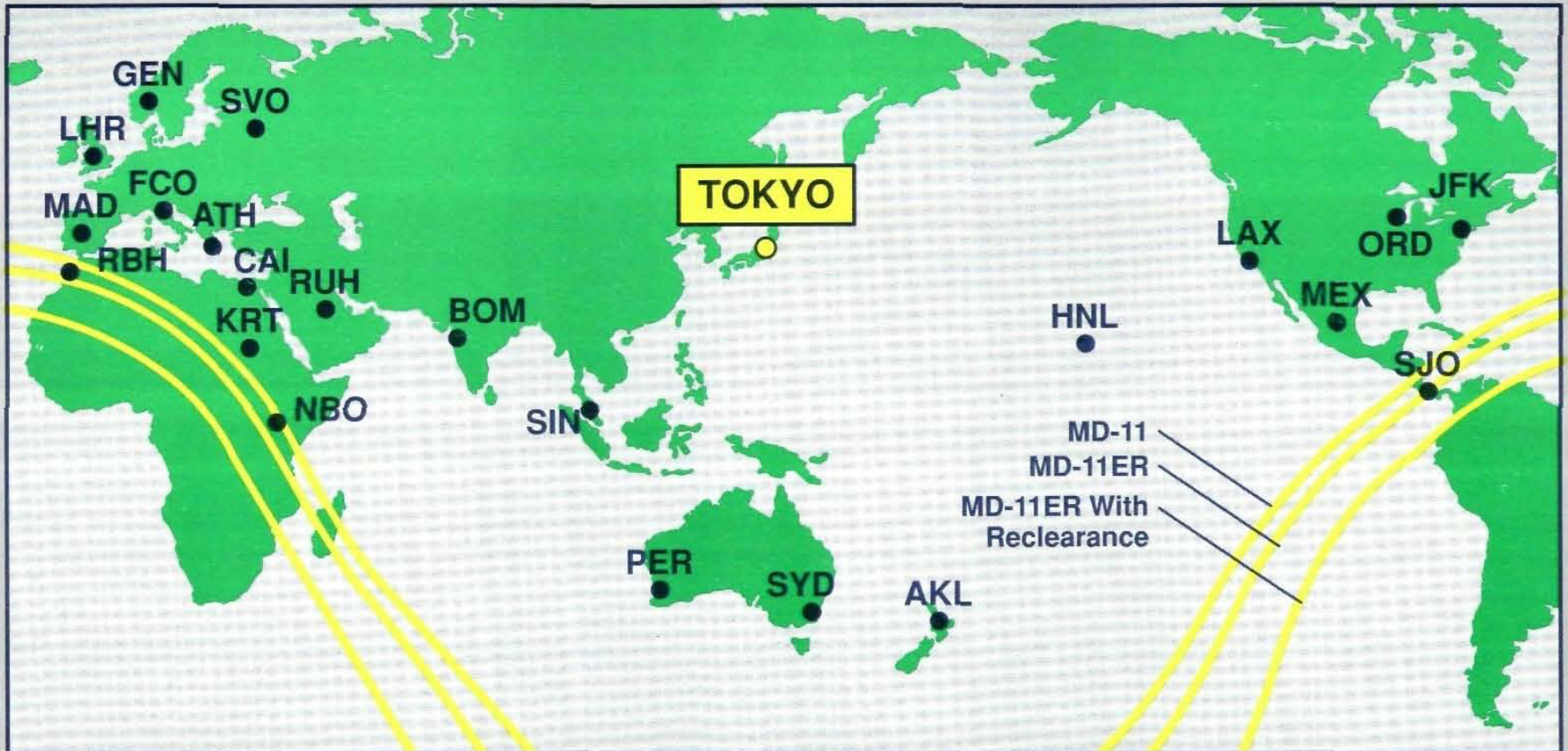

Full Passengers and Baggage Payload
International Reserves — 150-n-mi Alternate
3% Airways Factor
85% Annual Winds

VEC041-65

MD-11 Flight Deck

StartupBoeing

