

# MD-90

StartupBoeing





# MD-90

StartupBoeing



# MD-90 External Dimensions

StartupBoeing

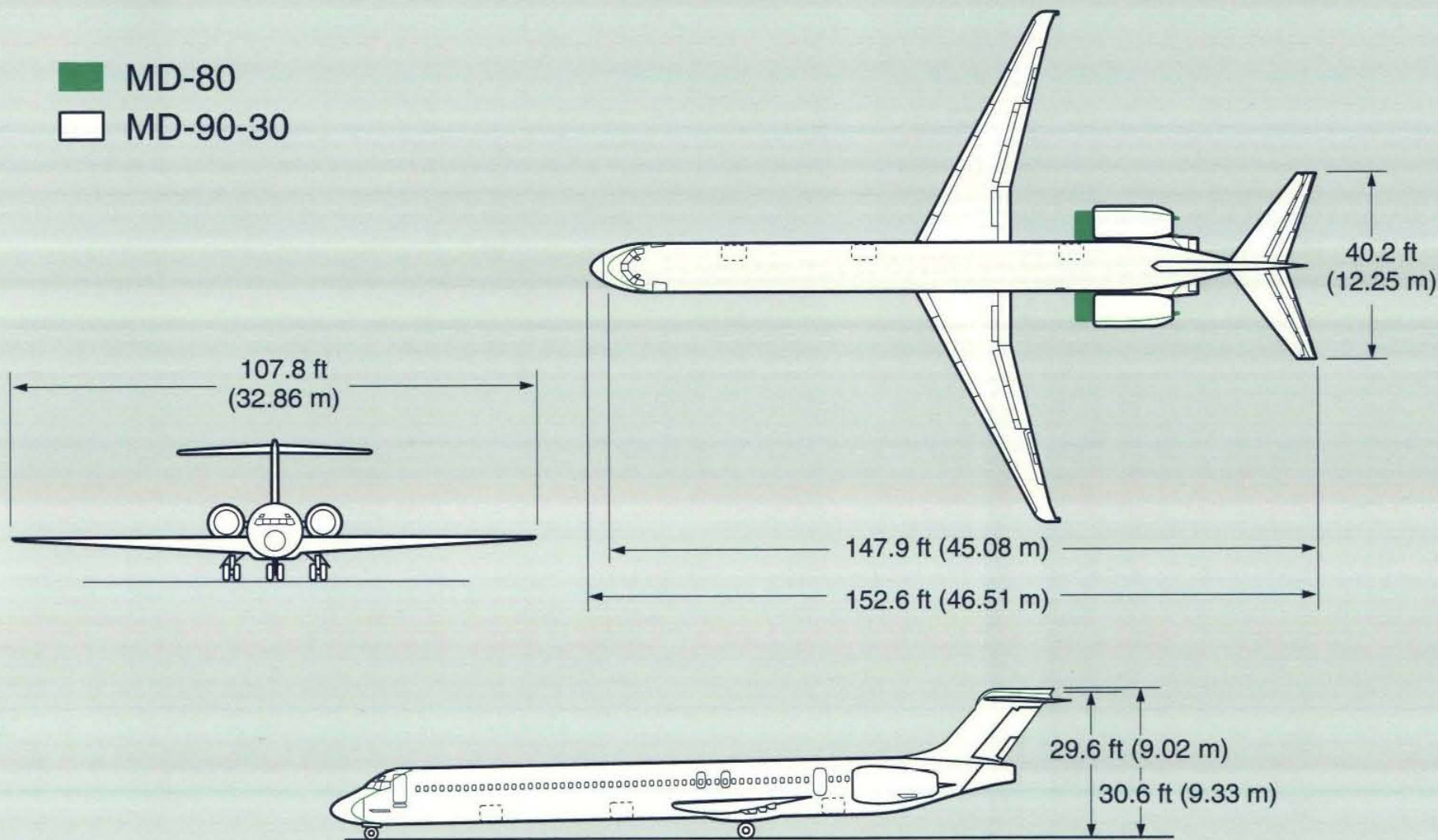



# MD-90 Interior Arrangements

StartupBoeing

## Mixed Class – 153 Passengers

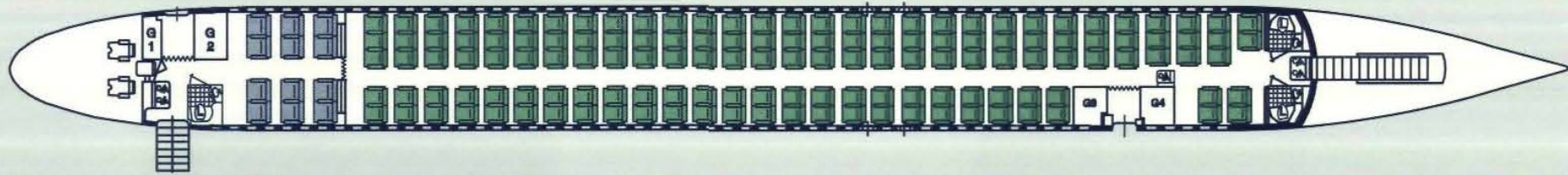

First 12 Seats, 36-in. Pitch  
Economy 141 Seats, 33/32/31-in. Pitch

J148725B

## Mixed Class – 158 Passengers

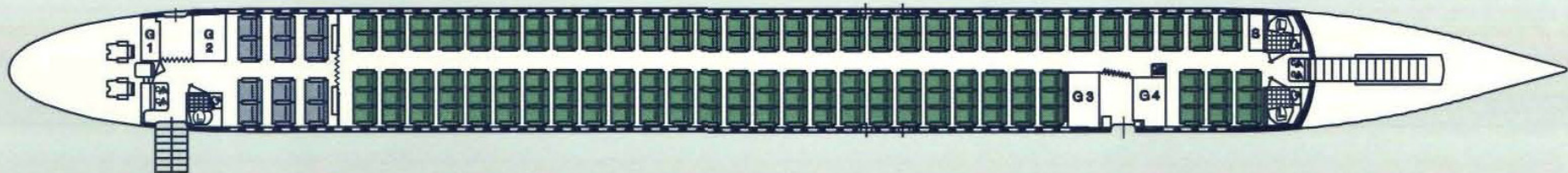

First 12 Seats, 36-in. Pitch  
Economy 146 Seats, 32/31-in. Pitch

J14572

# MD-90 Interior Arrangements

StartupBoeing

## Single Class – 163 Passengers

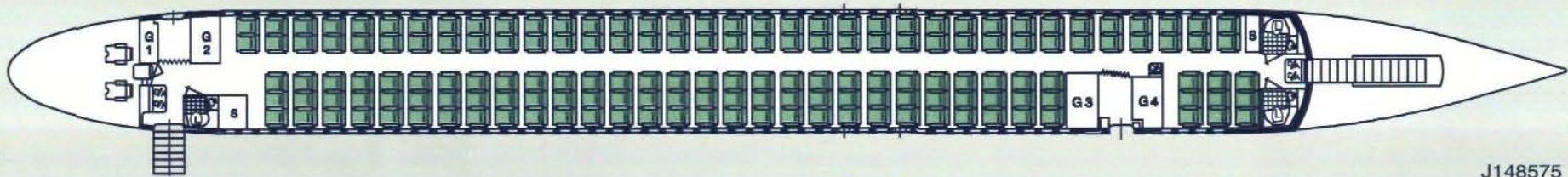

All Economy 163 Seats, 33/31-in. Pitch

J148575

## Single Class – 172 Passengers

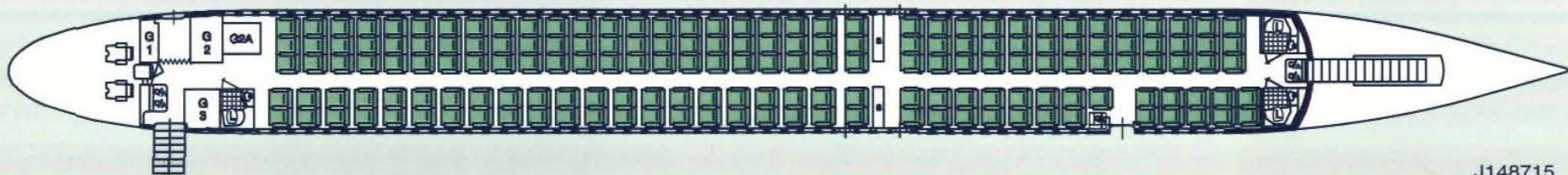

All Economy 172 Seats, 31/29-in. Pitch

J148715



# MD-90 Interior

StartupBoeing



# MD-90 Interior

StartupBoeing

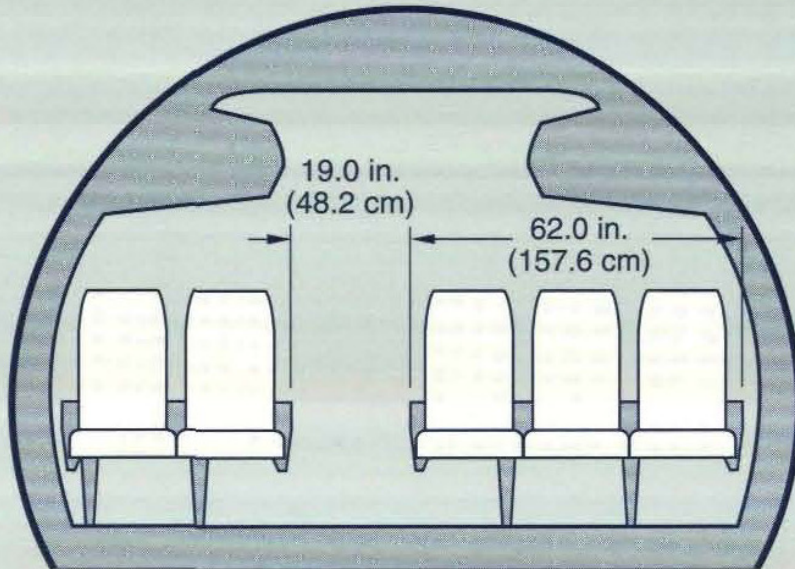

MD-90

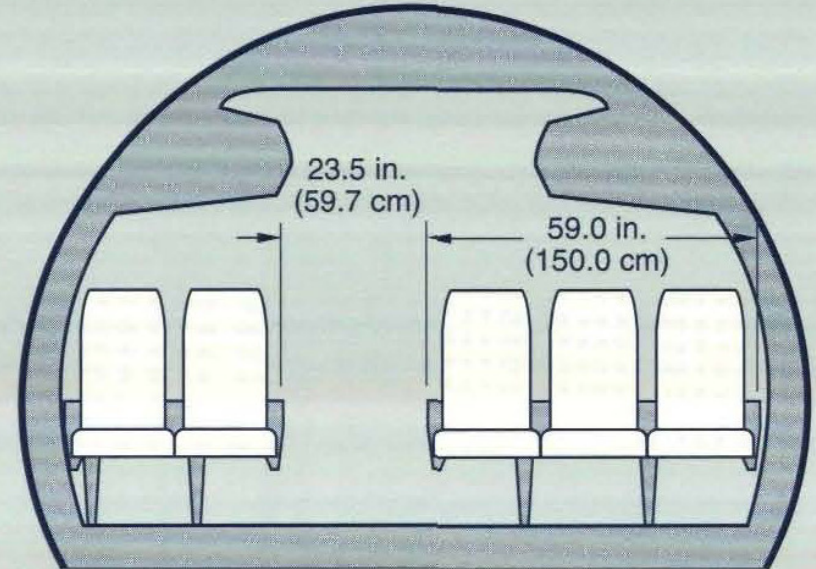

MD-90 Wide Aisle Option



# MD-90 Cargo Compartment

StartupBoeing

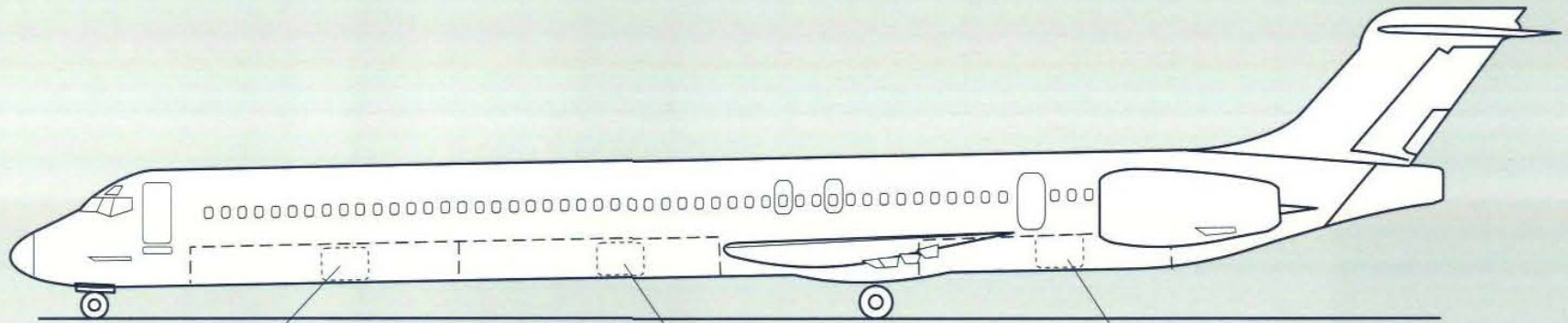

Forward Cargo  
Compartment Access  
53 by 50 in.  
(134.6 by 127.0 cm)

Mid Cargo  
Compartment Access  
53 by 50 in.  
(134.6 by 127.0 cm)

Aft Cargo  
Compartment Access  
53 by 50 in.  
(134.6 by 127.0 cm)

	Forward Cargo Compartment	Mid Cargo Compartment	Aft Cargo Compartment	Total Cargo
MD-90-30	434 cu ft (12.3 cu m)	466 cu ft (13.2 cu m)	400 cu ft (11.3 cu m)	1,300 cu ft (36.8 cu m)



# MD-90 Cargo Door Clearances

StartupBoeing

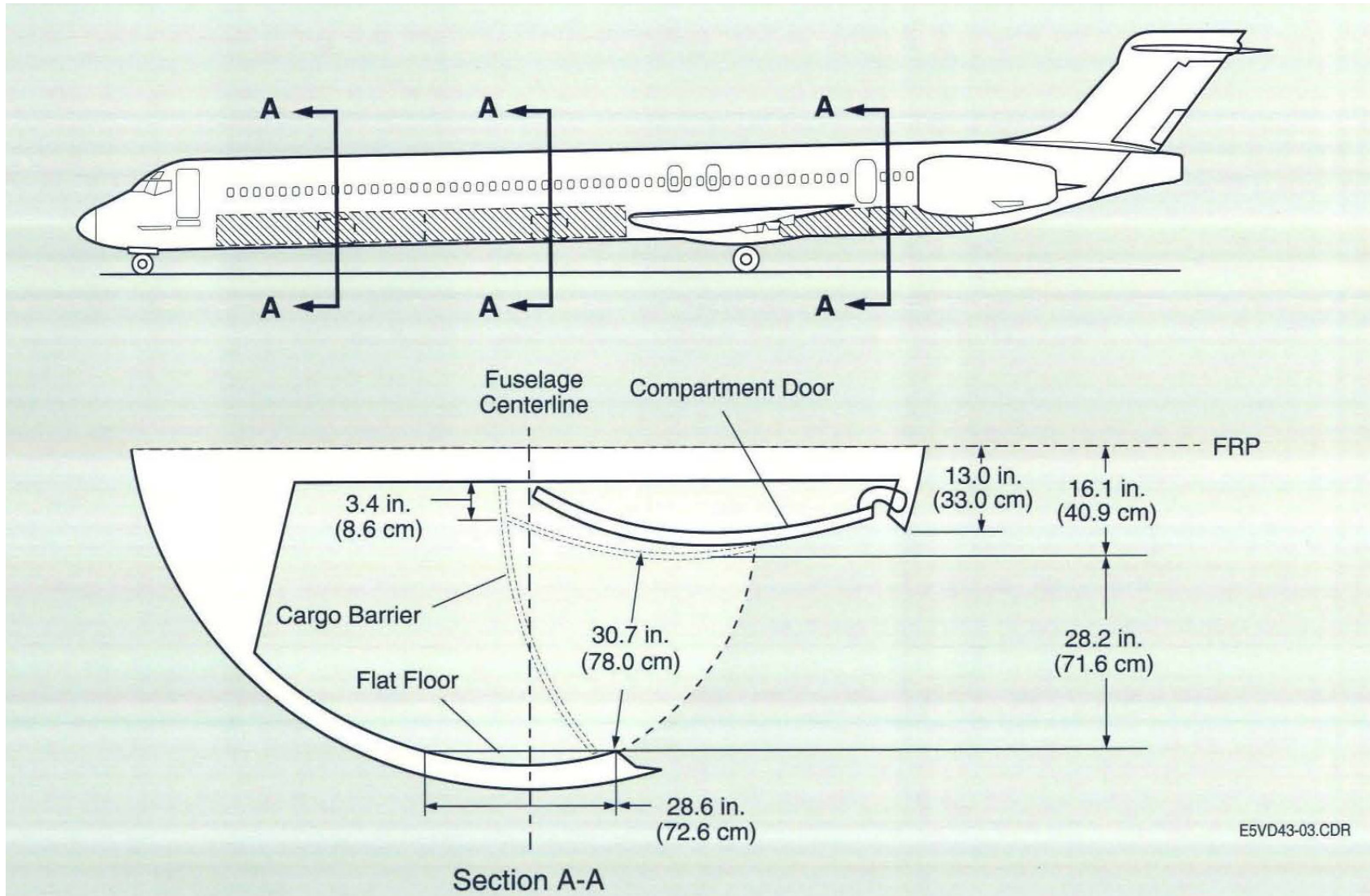

# MD-90 Cargo Hold

StartupBoeing





# MD-90 Characteristics

StartupBoeing

		<b>MD-90-30ER</b>	<b>MD-90-30ER*</b>
Engine		V2525-D5	V2525-D5
Passenger Capacity (Mixed Class)		153	153
Maximum Takeoff Weight	lb / kg	166,000 / 75,296	166,000 / 75,296
Maximum Landing Weight	lb / kg	142,000 / 64,410	142,000 / 64,410
Maximum Zero Fuel Weight	lb / kg	132,000 / 59,874	132,000 / 59,874
Operational Empty Weight	lb / kg	88,400 / 40,098	89,188 / 40,455
Fuel Capacity	lb / kg	39,128 / 17,748	42,913 / 19,465
Cargo Volume	cu ft / cu m	1,300 / 36.81	1,183 / 33.50
Range With Full Load of Passengers and Baggage	n mi / km	2,237 / 4,143	2,455 / 4,547

\* Optional 565 USG Auxiliary Fuel Tank

# MD-90-30 Characteristics

StartupBoeing

Engine		V2525-D5
Passenger Capacity (Mixed Class)	No.	153
Maximum Takeoff Weight*	lb / kg	156,000 / 70,760
Maximum Landing Weight	lb / kg	142,000 / 64,410
Maximum Zero Fuel Weight	lb / kg	130,000 / 58,967
Operational Empty Weight	lb / kg	88,200 / 40,007
Fuel Capacity	lb / kg	39,128 / 17,748
Cargo Volume	cu ft / cu m	1,300 / 36.8
Range With Full Load of Passengers and Baggage	n mi / km	2,045 / 3,787

\*Optional MTOGW 160,500 lb / 72,803 kg Available



# MD-90 V2500 Engine Characteristics

StartupBoeing

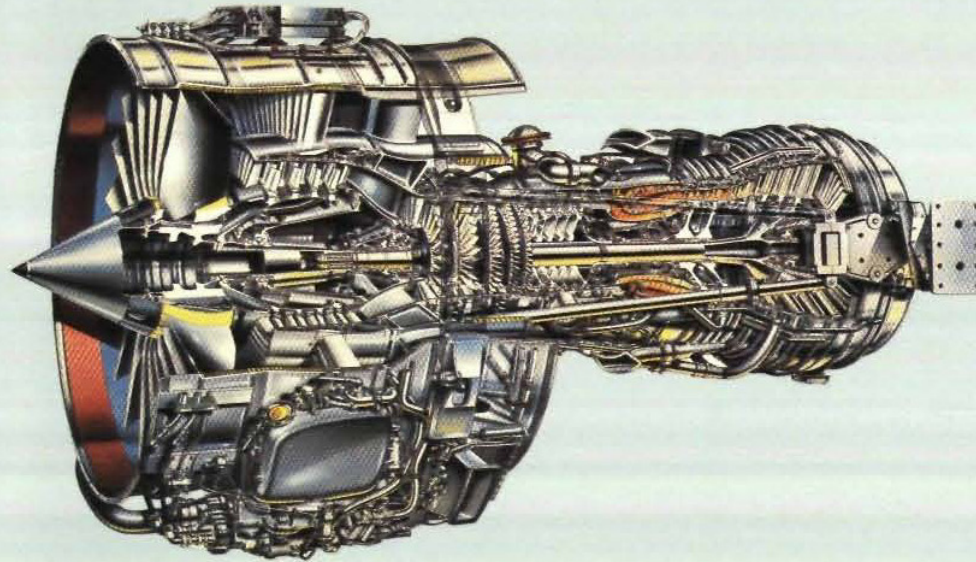

		<b>V2525-D5</b>	<b>V2528-D5</b>
Rated Thrust	(lb/kN)	25,000 / 111.2	28,000 / 124.6
Flat-Rated T.O.	(°F/°C)	86 / 30	86 / 30
Fan Diameter	(in./m)	63.5 / 1.6	63.5 / 1.6
Dry Engine Weight	(lb/kg)	5,252 / 2,382	5,252 / 2,382
Overall Pressure Ratio		27.7	30.4
Bypass Ratio		4.8	4.7

# MD-90 Payload-Range Capability

StartupBoeing

MD-90-30

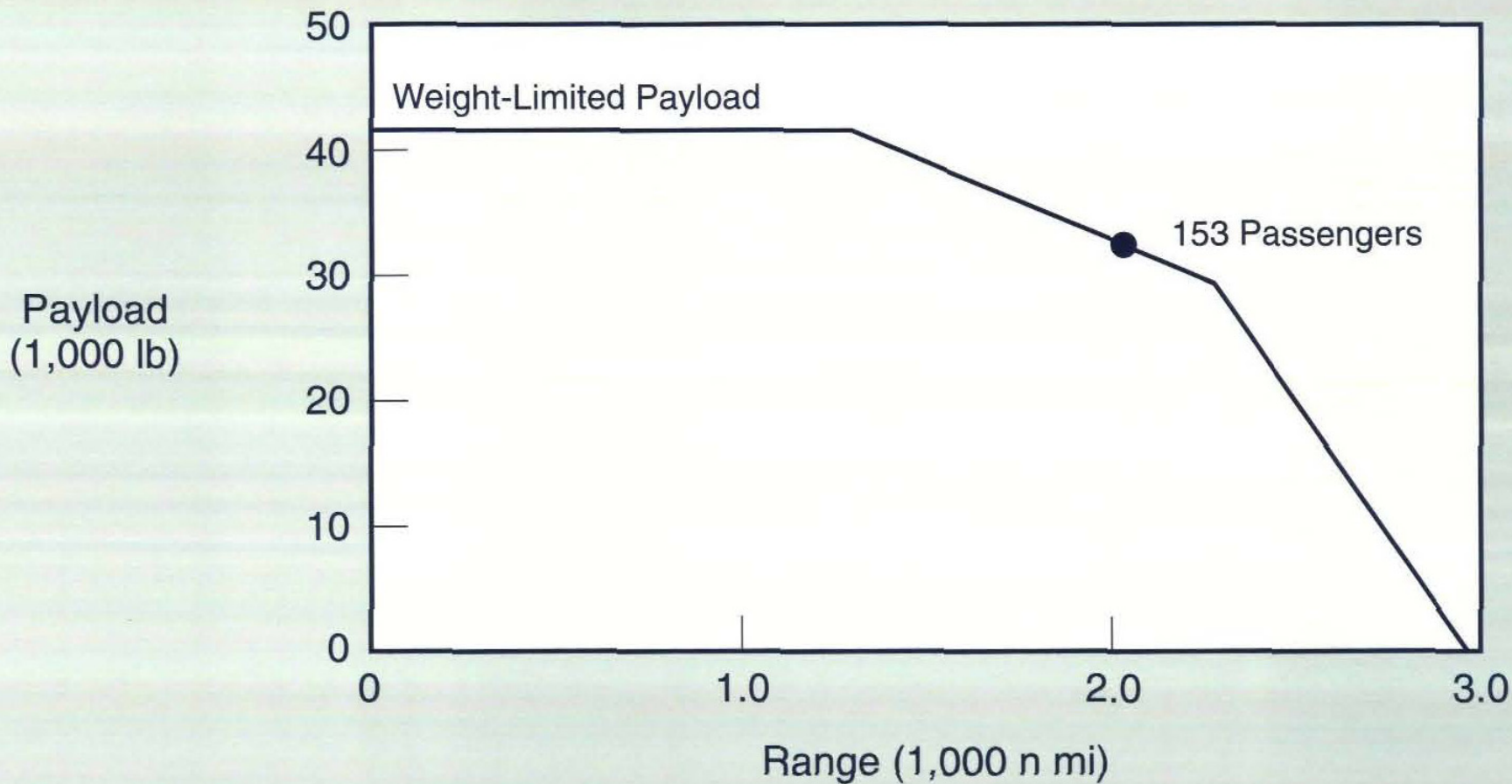



# MD-90 Mission Profile

StartupBoeing

## Typical Mission Rules

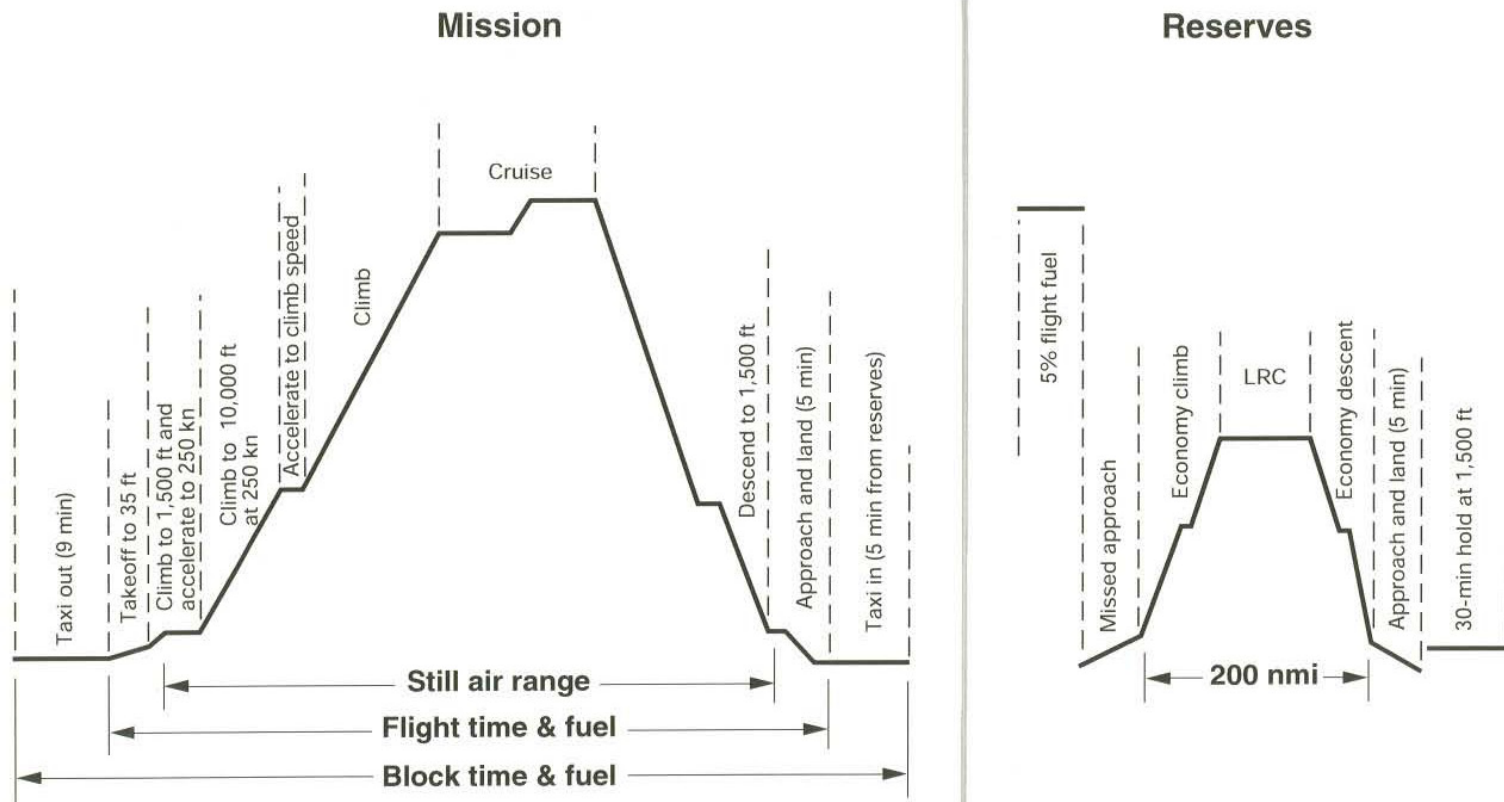

- Standard day
- Fuel density 6.7 lb/U.S. gal
- Nominal performance

# MD-90 Range Capability

StartupBoeing

## MD-90-30

From Beijing



From Kunming



85% Annual Winds  
Full Passenger Payload



# MD-90 Range Capability

StartupBoeing

## MD-90-30

### From New York

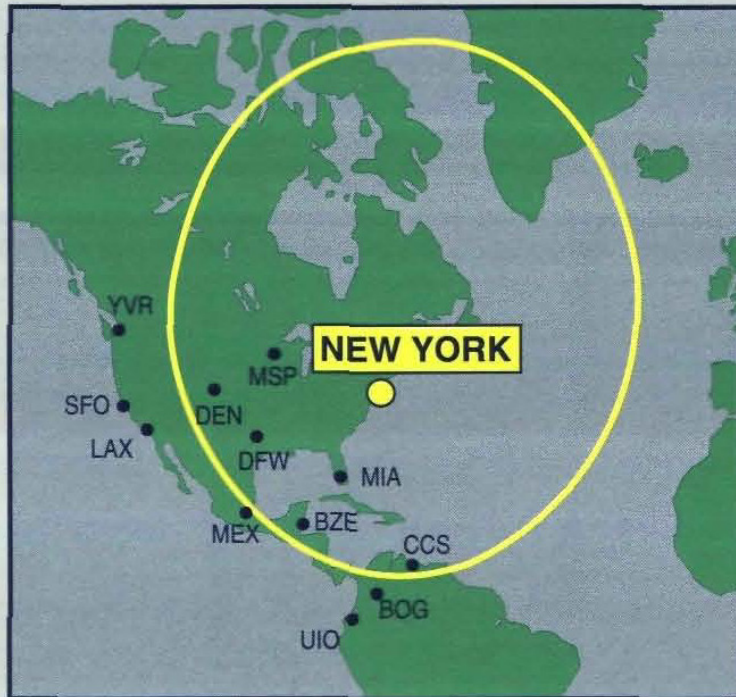

### From Rio de Janeiro



85% Annual Winds  
Full Passenger Payload



# MD-90 Range Capability

StartupBoeing

## MD-90-30

### From Rome

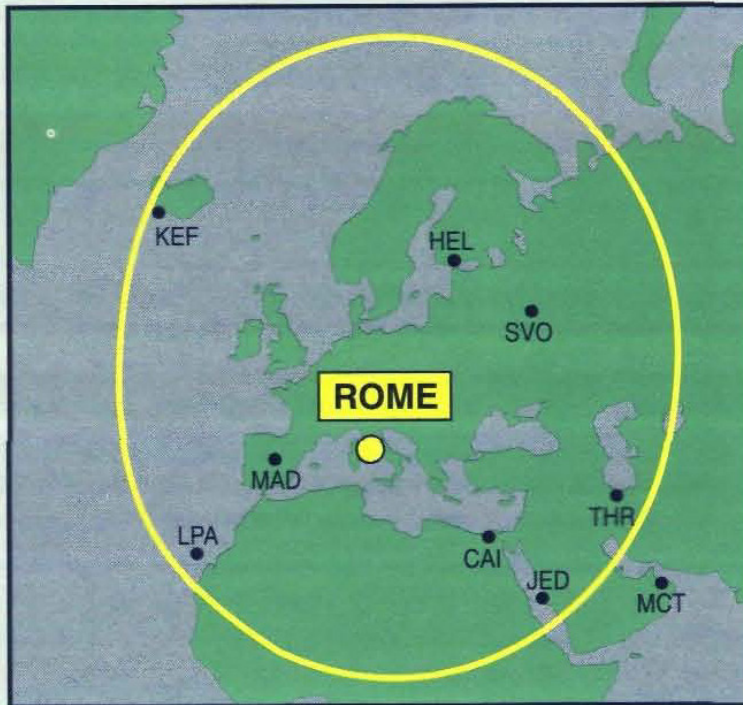

### From Bangkok



85% Annual Winds  
Full Passenger Payload



# MD-90 Flight Deck

StartupBoeing

