

# Innovation Quarterly

2018 November  
Volume 2, Issue 10

## **An Epic Challenge**

Changing the game  
in aerospace training

## **Going Digital**

A system of services

## **Point-to-Point Capable**

For more aircraft and  
more nonstop flights

**PUBLISHER**

Greg Hyslop  
Boeing Chief Technology Officer

**ASSOCIATE PUBLISHER**

Peter Hoffman  
VP Intellectual Property Management

**EXECUTIVE ADVISORY BOARD**

Heidi Capozzi, Todd Citron, Ted Colbert,  
John Hamilton, Lynne Hopper,  
Naveed Hussain, Gary Wicks

**EDITOR**

Candace Barron

**DEPUTY EDITOR**

Junu Kim

**CONTRIBUTING EDITORS**

Will Wilson, Allison Olson,  
Kathleen Kelly, Brianna Jackson,  
Lisa Maull, David Okrent

**GRAPHICS AND  
DESIGN EDITOR**

William Crane

**DESIGN TEAM**

Kim Proescholdt, Clayton Chu,  
Vaughn Hale, Doug Yamada, Joe Karolczak,  
Teresa Stanker, Mark Thibodeaux

**DIGITAL TEAM**

Conan Kisor, David Parke

**PATENT SPOTLIGHT**

Melanie Morrill

**BOEING TECHNICAL JOURNAL**

Ken Hardman, John Adrian

**TECHNOLOGY INTELLIGENCE  
AND TRENDS**

Marna Kagele

**LEGAL ADVISOR**

Tom Donahue

**COMMENTS**

Comments and letters are welcome and  
may be published in subsequent editions.  
To submit a letter to the editor, email  
candace.k.barron@boeing.com.

**WEBSITE**

boeing.com/IQ

**ON THE COVER**

Pete Boeskov, chief technologist and  
director of Training & Professional Services  
within Boeing Global Services.

PHOTOGRAPHY BY MARIAN LOCKHART

Featured

**6 | World-changing navigation**

Through Air Traffic Control Datalink Services, one of 10 winners of Boeing's 2018 Innovation Awards, Boeing is improving airspace management that ultimately allows more aircraft to fly at the same time. The innovation, which has been adopted on a global scale, has opened routes and enabled more point-to-point travel, including thousands of flights across the Atlantic Ocean.

**10 | Predicting the future through data**

While many companies are trying to deliver analytics capability to airlines, few of them have the domain knowledge to derive meaningful insights from the data. Predictive maintenance is one area of analytics that can offer great efficiencies and savings by knowing that something will likely happen and predicting when it will occur.

**18 | Virtual training that's Unreal**

In an interview with Pete Boeskov, Boeing's chief technologist for training, we learn about Boeing teaming up with Epic Games, the developers of the popular video game "Fortnite," and using their Unreal Engine to shake up the aerospace training industry through virtual and augmented reality.

**36 | Digitizing the airplane**

To improve airline operation efficiency and support the business development of aviation services in China, Boeing researchers collaborate with partners from Chinese universities to develop an automated system for airplane inspection using augmented reality.

Technical Papers

**24 | Investigation of Linear Motors as Electric Actuators for Aircraft**

The commercial aircraft industry has been moving toward more electric aircraft in recent decades, and engineers have evaluated existing hydraulic- and pneumatic-powered systems for conversion to electrical power. This paper describes whether a Thrust Reverser Actuation System could be improved by using linear motor actuators instead of hydraulic or electromechanical actuators.

**29 | What Is a Game-Changing Design?**

Recent research has demonstrated that the principles and practices of design thinking drive innovation. As a demonstration of the importance of this new paradigm, business schools are adding design studies to their curricula, new graduate schools that focus solely on design as a discipline are being stood up, and both business and scholarly literature are providing case studies of how design thinking is transforming corporate cultures and enhancing competitive advantage.



**Interchanges:  
Innovation to transform  
services technology**

Today's technology revelations will change the formula and timeline for innovation within and beyond the aerospace industry.

One thing I love about working at Boeing is knowing I work at a company that's fundamentally changed the world. We ushered in the Space Age with the X-15 hypersonic aircraft, Mercury, Gemini and Apollo programs. Our military aircraft, such as the AH-64 Apache, F/A-18 Super Hornet and F-15 Eagle, are vital tools in the defense of freedom. And thanks to our 7-series of commercial airplanes, we literally introduced the Jet Age.

The intent of Global Services, Boeing's dedicated services business, is to lead change once again—this time in the Digital Age. As a leader in digital aviation and analytics, Global Services uses technology to make commercial and defense airframes and platforms smarter, more capable and less expensive to operate. For example, our team ushered in the use of data analytics to create predictive and proactive approaches for our customers as they utilized aircraft health monitoring—increasing aircraft efficiency while lowering operating costs.

And bigger and better things are in work, thanks to the talented members of the Boeing team working together to solve difficult challenges and bring astonishing innovations to life. In the not too distant future, advancement in areas like virtual reality, autonomy and artificial intelligence will

change the way people travel, and the way our nation and its allies defend and protect. Things like pilotless airplanes and space tourism will become standard. Boeing will lead the transition in the way we design, manufacture and sustain for customers around the world.

Our success rests upon the shoulders of our current and future workforce. I truly believe that our most iconic achievements will happen at points of intersection—the interchange where innovative ideas cross to make technology work harder, faster and more cohesively than ever before. 



**STANLEY A. DEAL**  
President and Chief Executive Officer,  
Boeing Global Services

## Recognizing Advanced Developments and Research

# Technology RADAR

People working in Boeing's Technology Intelligence and Trends community of practice are human sensors in the world of science and technology. We make it our business to watch for innovations in practice, new business models and new ways of thinking. Here's a peek at a few signals on the screen.

### Robot Dialogue for Improv

**LOCATION** Edmonton, Alberta, Canada      **PROJECT URL** [humanmachine.live](http://humanmachine.live)

**MESSAGE**  
An "artistic experiment" from company Human Machine features context-relevant dialogue for improv comedy created in real time by an artificially intelligent chatbot.

### Hidden Codes for Counterfeit Prevention

**LOCATION** New York, New York      **PROJECT URL** [engineering.nyu.edu/news](http://engineering.nyu.edu/news)

**MESSAGE**  
Developed by New York University engineers, complex "clouds" of QR codes within 3D-printed parts would prevent counterfeits.

### Pepper-Picking Robot

**LOCATION** Wageningen, Netherlands      **PROJECT URL** [sweeper-robot.eu](http://sweeper-robot.eu)

**MESSAGE**  
A sweet pepper harvesting robot has demonstrated its viability for repetitive tasks in harsh environments.

### Smart Work Environments

**LOCATION** Abu Dhabi, United Arab Emirates      **PROJECT URL** [journals.elsevier.com/automation-in-construction](http://journals.elsevier.com/automation-in-construction)

**MESSAGE**  
Scientists at Abu Dhabi University's Research Center in Smart Services for Smart Cities have demonstrated the feasibility of an Internet of Things-based alerting system for hazard avoidance and accident prevention on construction sites.

### Three-Way Brain Wave 'Tetris'

**LOCATION** Seattle, Washington      **PROJECT URL** [arxiv.org](http://arxiv.org)

**MESSAGE**  
BrainNet, a system that connects the brain waves of three people, has been used to play the video game "Tetris."

### Real-Time 3D Print Quality Assurance

**LOCATION** Berkeley, California      **PROJECT URL** [lnl.gov/news](http://lnl.gov/news)

**MESSAGE**  
Researchers at Lawrence Livermore National Laboratory are developing convolutional neural networks to analyze 3D build quality in real time, based on just milliseconds of video.

### Genetically Engineered Spider Silk

**LOCATION** Quảng Nam, Vietnam      **PROJECT URL** [kraiglabs.com](http://kraiglabs.com)

**MESSAGE**  
As an example of the burgeoning synthetic biology market, production of genetically engineered spider silk, which is stronger than steel and water-proof, is being commercialized for use in civil and military applications.



# Link globally, act locally

**A look at an important—and underappreciated—technology that enables point-to-point air travel.**

BY DAN CAHILL, BOEING WRITER

“We figured out a way to fly point to point with smaller airplanes, and airlines found it more advantageous.”

TIM MURPHY,  
BOEING SENIOR TECHNICAL FELLOW

Ask most commercial aviation experts to list the technological advances that allow airplanes to fly nonstop between new transoceanic pairs of cities, and they'll probably cite improved engines or the proliferation of advanced materials.

But Boeing engineers Tim Murphy and Brad Cornell know the transoceanic flight boon can also trace its growth to another important technology that has nothing to do with propulsion or materials, and everything to do with computing power.

To prove their point, it helps to envision the world's most lucrative airspace: the North Atlantic. Unsurprisingly, it's also one of the busiest with about 3,000 aircraft per day.

Because of the long-duration flights, the North Atlantic corridor was once limited to mostly jumbo jets and some 757s and 767s. But that changed about 15 years ago when Boeing developed Datalink Services, an air traffic control system that allowed more planes to fly in tighter spaces, meaning more direct routes and less fuel consumption.

The result: More twin-engine jets such as the Boeing 737 MAX, 787 Dreamliner and 777 can make those runs and have become the preferred option by airlines in North Atlantic airspace. That explains why, since the start of this century, Boeing has stood firm in believing that the future of air travel involves creating airplanes that will take passengers where and when they want to go—and doing it nonstop.



“We figured out a way to fly point to point with smaller airplanes, and airlines found it more advantageous,” said Murphy, a Boeing Senior Technical Fellow with 30-plus years of experience in guidance, navigation and control technology.

Sounds simple, right? It's not.

The implementation and execution of Datalink Services took forward-thinking by Boeing and years of innovative work by hundreds of employees.

To fully grasp the monumental task of transforming air traffic control, let's go back to the radio days.

“In the past, the pilot would have to talk to the controller, who would give a lot of steps,” Murphy said. “The steps would have to be written down and read back to the controller, and then the pilot would enter them into button pushes.”

In international airspace, communications were difficult because of atmospheric interference. This would increase workload and error potential.

Boeing realized the limitations of voice communication and knew the method would not serve the company's global strategy of connecting the world.

With the 747 as its model, Boeing introduced the Future Air Navigation System (FANS) in 1995 in the South Pacific Oceanic Region.

“Instead of pilots talking to controllers, we have computers talking to computers,” Murphy said.

Increased navigation accuracy with the use of GPS and improved communications with Datalink helped put transoceanic planes on their most direct and safest routes, enabling more point-to-point paths in closer proximity.

Goodbye, hub-and-spoke jumbos. Hello, versatile twin-engine aircraft.

From there, the Boeing team kept refining the technology until they felt comfortable using it in the densely populated North Atlantic airspace.

“Traditionally, everything was done by voice,” said Cornell, Flight Crew Operations Integration engineer.

“Because of that, there were certain limitations allowed in terms of separation standard. Removing the constraints in airspace would allow more point-to-point flights. Air Traffic Control Datalink Services was developed to remove those constraints.”

Murphy draws a comparison between Datalink and Waze, the community-based navigational app for vehicles.

“Think of it as an internet for airplanes,” Murphy said. “It’s even more fundamental for airplanes because it has to tell them where the roads are and which can be used.”

With the FAA on board, the system is now used by about 80 percent of the airplanes flying transoceanic routes and has been implemented in a majority of airports around the United States.

Murphy and Cornell’s team has also been able to replicate Datalink Services from Boeing’s commercial airplanes to several defense programs.

“It was a little tricky, because I think the intention had always been to make this ubiquitous,” Murphy said. “But it was only implemented on the 747-400 at first.”

For their efforts in duplicating Datalink Services across the enterprise, Murphy and Cornell’s team received the 2018 Technical Replication Award, a Boeing employee honor that recognizes the spread of innovation across the company.

Cornell admits that none of this would have been possible if not for the initial leap of faith more than 20 years ago, implementing FANS on the 747.

“When we first put it into service, there were a few problems,” Cornell said. “But we worked together with other stakeholders and solved those problems. Boeing earned a reputation as an industry leader in this technology. Once we got it under control, it replicated organically.”

Murphy admitted it was a bit tenuous at first.

“If not for the success in all phases in the oceanic airspace, we may not have gone down this road,” Murphy said.

“Datalink is really the cornerstone to the future of navigation.

“At the end of the day, it’s all about managing the efficiency of the airspace and enabling more airplanes.” **IQ**

“ Boeing earned a reputation as an industry leader in this technology. Once we got it under control, it replicated organically. ”

**BRAD CORNELL,**  
FLIGHT CREW OPERATIONS  
INTEGRATION ENGINEER

**LINKED UP**

Boeing engineers Tim Murphy (left) and Brad Cornell, in a flight deck cab at Boeing’s Integrated Aircraft Systems Lab in Seattle.

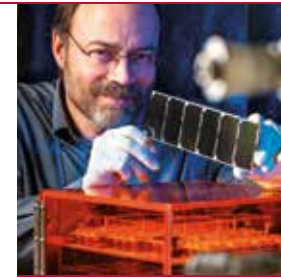

**BRIAN TILLOTSON**  
SENIOR TECHNICAL  
FELLOW

Earlier this summer, the United States issued patent number 10,000,000. This followed only three years after patent number 9,000,000.

The first million U.S. patents took 75 years, from 1836 to 1911. Invention today is going faster. But why?

A century-old joke holds that a U.S. patent commissioner said, “Everything that can be invented has been invented.” In reality, invention works the opposite way. The more things people invent, the more things people can invent.

Let’s look at U.S. Patent 10,000,000: Coherent LADAR Using Intra-Pixel Quadrature Detection. It uses a laser to make a picture where the brightness of each pixel shows distance to some part of the scene. Lots of people have done this already. An inventor at Raytheon figured out how to do it better using things other people had invented: a laser, optical systems, focal plane arrays and other electronics. He couldn’t come up with this invention until the others were available.

There’s the same pattern in most other patents. U.S. Patent 1,000,000 is an improvement in vehicle tires. Can’t invent that until you have both vehicles

# 10,000,000 and counting

and tires. U.S. Patent 4,000,000 is a process for recycling asphalt. Can’t invent that until you have asphalt.

And so on.

Now if you’re in a company that needs a steady supply of new products or technologies, what can you do? Answer: Try to help your employees keep up with what’s already been invented.

Obviously we can’t do that for all kinds of invention, but we don’t have to. In the aerospace industry, we probably don’t need to know about the latest patented rosebush (yes, you can patent plants) or cat toy. But it’s helpful to know what new ideas are coming along for airplanes, spacecraft and the items that go inside them.

**How do we do that? Here are a few ideas.**

1. Have a big annual conference for employees. Let people from all around the company show their latest work. At Boeing’s conference, experienced engineers from our spacecraft division rub elbows with interns in our helicopter factories. Everybody goes home glowing with new ideas.
2. Have an internal technical journal. Much of your company’s best, most innovative work is proprietary—you can’t publish it outside the company. Boeing has a high-quality, peer-

reviewed journal for internal work. It lets all our people keep up on the latest problems and the newest solutions.

3. Have a team focused on matching needs to good ideas. Boeing has a technology strategy group with engineers who keep a thumb on the pulse of all R&D across the company and on the needs of our various businesses. If an employee in India has a solution to a problem in St. Louis, these engineers put them in touch.

These ideas are not unique. Microsoft Research has a conference. IBM has a journal. But if more organizations practice this innovation-accelerating behavior, the U.S. Patent and Trademark Office will be issuing patent number 11,000,000 in no time. **IQ**

Brian Tillotson is the Boeing Senior Technical Fellow for Systems Engineering specializing in sensors and apertures and platform energy systems technology.



# Prescriptive insight

Advancing the possibilities of data analytics for more efficient maintenance management.

BY DARREN MACER, ASSOCIATE TECHNICAL FELLOW  
BOEING GLOBAL SERVICES

Through the use of data analytics, powerful and fast computing hardware, and ubiquitous high-bandwidth data communications, the role of software is progressing from servant to co-worker—an equal member of the team as a result of artificial intelligence, machine learning and other data science techniques. This enables the world of predictive and prescriptive analytics—the ability to predict that something will happen and then prescribe what action should be taken to either prevent or correct it.

The accuracy needed to achieve the full potential of predictive and prescriptive aerospace analytics, however, occurs from a close collaboration between data science and aerospace experts in converting information into new insights, opportunities and applications. This is the basis of Boeing AnalytX, the collective efforts of thousands of Boeing experts working together to advance aerospace and deliver a new generation of analytics-enabled products and services.

Data analytics are typically grouped into four types: descriptive, diagnostic, predictive and prescriptive.

Descriptive analytics identifies that something occurred, for example, a high temperature limit being reached. Diagnostic analytics focuses on supporting root-cause analysis.

With advances in data science, processing techniques and power; a good supply of data; and deep domain knowledge, we are able to determine the health of a component or system, and predict when it is degrading and when it will fail. This provides the basis for predictive analytics—

the capability to peek over the time horizon, getting a heads-up to a potential future situation.

Armed with this information, an organization can better prepare to manage a situation in advance rather than react after it happens. Boeing embeds fault logic into our aircraft and has a long history of both onboard and off-board processing of data, through mathematical and statistical methods, to provide predictive alerts and recommendations via Airplane Health Management. Now through advances in computing power linked with data science techniques and proprietary capabilities, Boeing is able to predict the future for issues not generally detectable by humans.

What happens when an operations center receives a predictive alert? Traditionally, this is when people take over, and the software goes back to monitoring, or other software is used to support identifying and evaluating viable options.

By harnessing the techniques from descriptive and diagnostic capabilities and linking with the ability to predict an event, we are now able to know what will happen, when it will happen, and also what should be done to correct it—this is prescriptive analytics, answering “What needs to be done?”

Answering that question is just the first step of what prescriptive analytics can do. The next levels raise the software to an equal co-worker—where diagnostic, predictive and prescriptive analytics work together to take autonomous action within user-defined constraints. This leaves the more complex issues to people, playing to their strengths, such as creativity, adaptability and innovation.

Boeing is one of the few companies to combine analytics and deep domain expertise under one roof.

The new digital frontier opened by Boeing AnalytX provides autonomous and semi-autonomous systems in support of technical operations spanning the airplane, fleet and enterprise.

It takes more than expertise in data analytics to deliver aerospace analytics capabilities to the industry, however. It also requires wide and deep industry and domain knowledge. Boeing is one of the few companies to combine analytics and deep domain expertise under one roof, enabling it to efficiently transform data into meaningful and valuable insights.

Prescriptive maintenance can offer great efficiencies and savings to an operator by looking ahead, watching for precursor events, and converting unscheduled maintenance events into scheduled ones. Predictive maintenance also helps with routine maintenance such as brake wear or oil consumption, and it enables health-based condition monitoring through detecting component or system degradation.

As problems become more challenging and signatures of degradation more subtle, the traditional engineering- and physics-based approaches require assistance. This is driving engineers and data scientists to use artificial intelligence techniques, such as machine learning. When these capabilities are paired with Boeing's experience

## DATA ANALYTICS IS A TRANSFORMATIONAL SCIENTIFIC PROCESS

It's a set of tools enabling people to explore a new world—the invisible world of data.

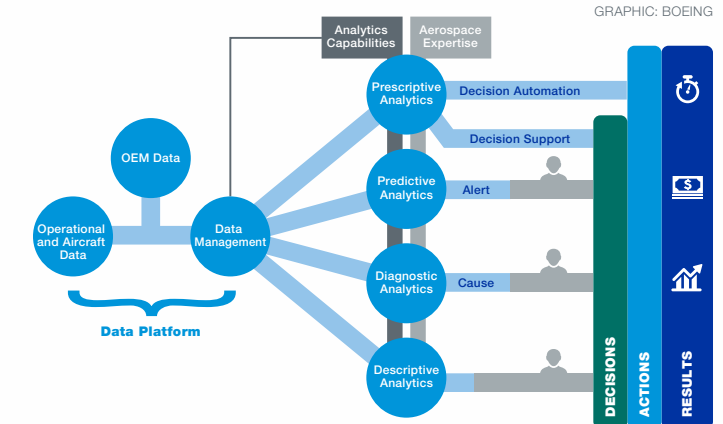

## CREATING A PREDICTIVE-PRESCRIPTIVE MAINTENANCE SYSTEM IS MORE THAN JUST APPLYING ALGORITHMS. IT MUST INCLUDE:

- Data acquisition and conditioning.
- Domain expertise for understanding the data.
- Automatic methods to correlate and blend data from multiple sources.
- Applied data science techniques to examine data and detect interesting features like failure precursor events.
- An alerting engine.
- An evaluation engine based on the the system's design and the historical effectiveness of previous actions, an evaluation criteria for assessing various options, and a method for delivering the options in a meaningful way.
- The capability to gather feedback on actions taken; understanding the effectiveness of the recommendation that was made.
- A method to continuously monitor the entire system.





Boeing AnalytX combines data science technologies with the collective efforts of thousands of Boeing experts working together to advance aerospace and deliver a new generation of analytics-enabled products and services.

#### BOEING ANALYTIX:

- Transforms data into insights and new opportunities.
- Delivers analytics offerings to help optimize processes and operations.
- Provides a glimpse into the future—more time to manage rather than react to situations.

and expertise, early prediction and accurate prescription become possible.

We now have the capability not only to predict a failure, with sufficient time to allow for consideration and planning, but to also prescribe exactly what actions should be taken to correct the problem in a clear and methodical way. Both prediction and prescription must be completed with the highest level of accuracy to provide a measurably better outcome than existing reactive methods or based only on the technician's know-how.

To best illustrate the approach and capability, the following is an example of what happens when a Boeing monitored 787 aircraft lands at an airport capable of offloading data. The aircraft automatically transfers the full flight data to a ground network to be processed through the cycle detailed below, progressing to prescriptive instructions via Boeing applications.

- LSAP Librarian Suite—a unified capability for airlines to efficiently transfer large amounts of data to and from airplanes. It offloads the full flight sensor data from an aircraft and delivers it to the Boeing environment.
- MAESTRO, which stands for mass-data analytics engineering system—translator, repository and orchestrator, is an automated system that takes the binary data from the onboard recording systems and converts, translates, analyzes, stores and publishes flight recorder data in reusable engineering units.
- Boeing AnalytX Data Warehouse—Big data storage and processing capability.
- Automated assessment by a proprietary Parameter Manipulation Language easily enables research, understanding and processing of the data.

- Automated Predictive Environment—Rules engine that runs algorithms on the data and appends instructions enables machine learning and engineering-based predictive alerts to be applied to the inbound, processed data.
- Prescriptive detailed work instructions, identified through engineering knowledge and machine learning methods, are automatically appended to the alerts.
- Prescriptions, such as parts and a mechanic, are scheduled at a future stop in order to perform maintenance without disrupting operations.

This capability, enabled by deep domain knowledge and empowered by artificial intelligence benefits customers by reducing unscheduled maintenance, resulting in higher schedule reliability.

Predictive and prescriptive analytics provide views over the time horizon, extend situational awareness, and gain more time to think, plan, prepare and manage situations rather than just react to them. **IQ**

#### ACCURATE AND INFORMED PREDICTIONS

This chart shows a graphical representation of a model that predicts the performance of a component from the onboard sensors, recorded at 1Hz, and offloaded after flight at which time the computers at Boeing automatically begin crunching the data and making predictions. With the performance predicted with a high enough level of accuracy, engineers are able to detect both sudden degradations and slow but lengthy decays. These detected situations allow engineers to alert and prescribe actions to mechanics before cascading failures cause high maintenance costs and/or schedule interruptions.

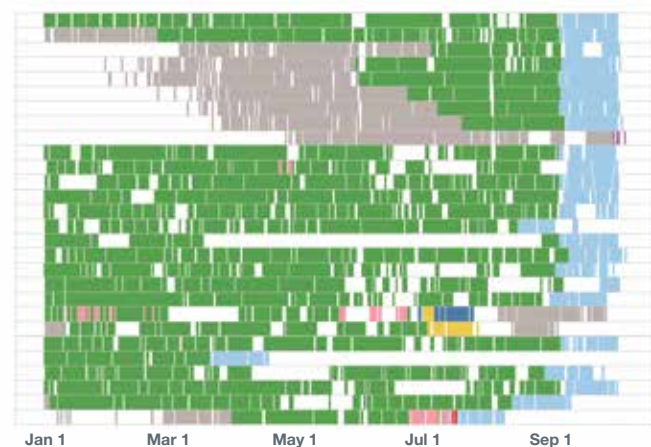
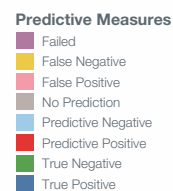

# Saving minutes

## How Boeing helps airlines improve on-time departures.

BY ADAM MERTZ, BOEING WRITER



PHOTO: JOSH GREEN

#### MAKING THE CONNECTION

Boeing's new RouteSync service allows KLM Royal Dutch Airlines pilots to instantly upload pre-flight data. The service is available for Boeing airplanes and other commercial aircraft.

“This is a highly reliable and accurate runway-to-runway route uplink solution.”

LOUIS BAILEY,  
BOEING ASSOCIATE TECHNICAL FELLOW  
AND LEAD ENGINEER

Call it an “easy button” for airline pilots.

Boeing's new RouteSync service takes the task of typing in preflight data from tedious to instant helping ensure on-time departures and arrivals for passengers. KLM Royal Dutch Airlines uses it to automatically uplink flight plans and performance information to the flight management system (FMS).

The new software saves pilots between three to five minutes on domestic flights and up to 15 minutes for international travel.

“RouteSync saves me somewhere between five and 10 minutes on a long flight,” said Frank Mannaerts, who pilots a 787 Dreamliner for KLM Royal Dutch Airlines. “It just gives me so much more time to interact with the passengers and speed up the boarding process to ensure an on-time departure.”

Developed by Boeing's advanced research division and commercialized by Boeing Global Services, RouteSync can instantly upload the flight plan route, alternate flight plan and performance data. The software verifies the route between FMS and airline dispatch systems, and it won't uplink the preflight data if there's an error in the flight plan.

“This is a highly reliable and accurate runway-to-runway route uplink solution,” said Louis Bailey, a Boeing Associate Technical Fellow and lead engineer. “It also performs route verification and removes and inserts flight plan discontinuities. Insertion of a discontinuity is used to call pilot attention to a critical segment in the flight plan.”

Boeing formed a partnership with KLM Airlines to test the RouteSync service. During a six-week period, it was used to uplink 4,021 flight plans. In total, RouteSync saved KLM pilots between 200 and 335 hours, according to program officials.

“RouteSync provides significant improvements in aircraft connectivity to support flight efficiency applications,” said Jim Hamilton, Boeing's portfolio manager for flight efficiency solutions. “It has the added benefit of increasing safety by verifying FMS data entered or modified by pilots and ensuring it is consistent with the flight plan.”

KLM Airlines has fully integrated RouteSync on several aircraft types in its fleet, as the service is available for Boeing airplanes and other commercial aircraft. **IQ**



TECHNICAL EXCELLENCE. **ENGINEERING ACHIEVEMENT.**

# Congratulations

## 2018 Boeing Innovation Award Winners



### Special Invention Awards

Evaluated and selected on the basis of the following criteria: degree of technical innovation, the innovation's impact to the company, degree of implementation, internal business value to Boeing, business value to customers and licensing value to Boeing.

Daniel Alvarez  
Rodney Cameron  
Ming Chen  
Justin Cottet  
James Cusworth  
Mark Davis

Robert DiChiara  
Sean Flannigan  
Michael Foster  
Peter Heisen  
Vedad Mahmulyin  
Mitchell Mellor

Dan Miller  
Brian Rupnik  
George Sonnenburg  
Jimmy Takeuchi  
Randal Ternes

### Technical Replication Awards

Highlight the most successful projects where cross-enterprise collaboration, learning and replication have driven productivity, growth and program execution.

Curt Althage  
David Augustine  
Matt Bergsman  
John Boggio  
Brad Cornell  
Alberto Deco  
Kris Douglas  
James Ethington  
Daniel Gilbertson  
Ann Guan  
Joshua Henry  
Jason Keller  
Geojoe Kuruvila

Stephen Lee  
Wei-Lin Li  
Kent Loving  
Joseph Mast  
Michael Matyas  
Rob Mead  
Dung Nguyen  
Shannon Parker  
Rochelle Perera  
Stephen Poteet  
Lesley Quach  
Christopher Raab  
Parminder Rai

Bijan Rashidian  
Richard Rawls  
John-Paul Sabino  
Liessman Sturlaugson  
Kevin Swearingen  
Richard Joel Thompson  
Jeff Thompson  
Zack Thunemann  
Rodney Tjoelker  
Chris Wezdenko  
John Wilson  
Troy Winfree  
Yadan Wu



# To Build the Future

**Boeing and NSF unite to develop a stronger STEM workforce.**

BY JANET DE LA TORRE, BOEING WRITER

Similar to other high-tech companies, Boeing's talent strategy focuses its efforts on a number of challenges, including the forecast shortage of skilled workers in critical areas.

In its continued effort to develop the future workforce and modernize employee learning, Boeing is partnering with the U.S. National Science Foundation (NSF) to provide employees with training and development in critical-skill areas. The investment focuses on model-based engineering, model-based systems engineering, mechatronics, robotics, data science and sensor analytics, program management, cybersecurity and artificial intelligence.

## Science and Engineering

Indicators from the National Science Board

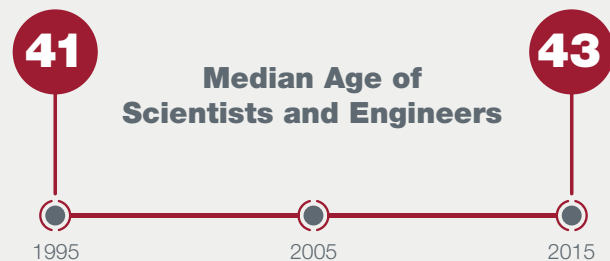

## Scientists and Engineers in Their 60s on the Rise

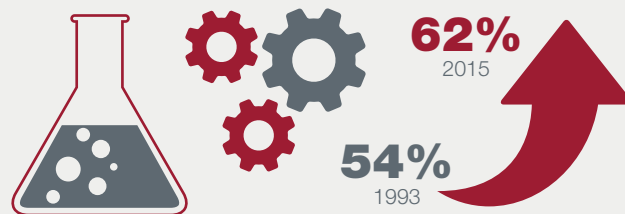

## Science and Engineer Occupations

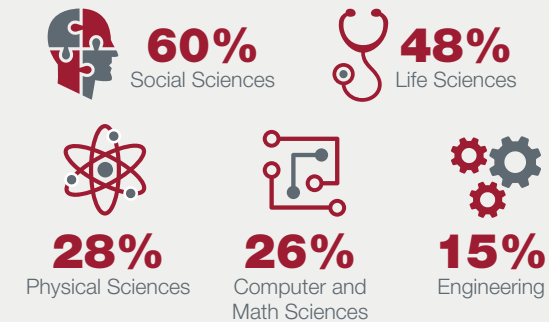

## Women in the Workforce

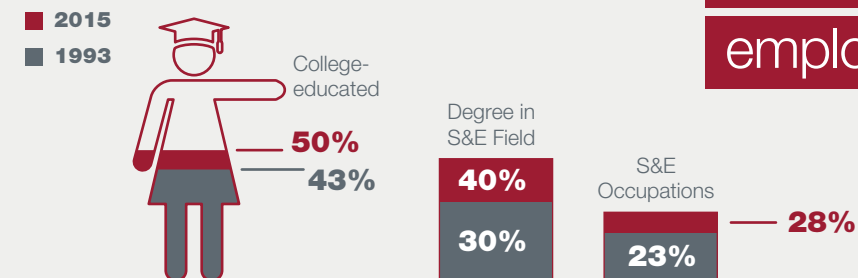

“This investment demonstrates Boeing’s commitment to developing the future workforce and our current employees’ skills.”

**HEIDI CAPOZZI,  
SENIOR VICE PRESIDENT  
OF BOEING HUMAN RESOURCES**

The partnership also will focus on increasing diversity in science, technology, engineering and mathematics (STEM) careers.

Anthony Falteisek, a supply chain specialist at Boeing Global Services who completed his Master of Science degree in business analytics through online courses and Boeing's Learning Together Program, was excited to learn about the Boeing and NSF partnership.

Through the Learning Together Program, employees can pursue degree programs, professional certificates and individual courses in strategic fields of study at more than 270 quality colleges and universities.

“Workforce development investments are one of the steps we can take to help current employees grow,” Falteisek said. “The real value in online coursework is the variety and flexibility.”

Boeing is investing \$10 million in the NSF initiative, complemented by another \$10 million from the NSF, to create online microcertificates at the community college, undergraduate, graduate and professional levels for employees and students.

The NSF will leverage its established network of academic institutions to solicit proposals and then grade on intellectual merit. It will select and award contracts to develop the certificates that best address future skills gaps.

The online curriculum is expected to launch in 2019. At that time, certificates would become available for credit to community college, undergraduate and graduate students, as well as Boeing employees. Continuing education units are available to students with verified credentials, or they can audit for free.

“This investment demonstrates Boeing’s commitment to developing the future workforce and our current employees’ skills,” said Heidi Capozzi, senior vice president of Human Resources at Boeing. “The initiatives will help develop more technical workers and provide research opportunities for women and veterans seeking to join or return to the STEM workforce.”

Boeing is making a separate gift of \$1 million to NSF's INCLUDES (Inclusion across the Nation of Communities of Learners of Underrepresented Discoverers in Engineering and Science) initiative. This initiative supports research and development regarding opportunities for women who have been out of the workforce and seek to successfully return to employment in STEM fields. The investment aligns with a Boeing program that provides internships to midcareer female professionals returning to work after a leave of absence.

According to the latest figures from the U.S. National Science Board's Science and Engineering Indicators, the number of jobs requiring substantial STEM expertise has grown nearly 34 percent over the past decade. However, employers nationwide say they are having trouble filling jobs in occupations that depend on skilled technical workers.

Those initiatives further Boeing's pledge to allocate \$300 million to its employees, infrastructure and local communities as a result of U.S. tax reform savings. In support of employee development, Boeing launched a digital learning portal earlier this year hosted by Degreed.com, which offered personalized and unlimited access to online lessons, certification courses and degree programs. [IQ](#)

# Pete Boeskov

is making epic changes to the world of flight training.

**Boeing is teaming up with Epic Games, the developers of the popular online video game “Fortnite,” to shake up the aerospace training industry through advanced use of virtual and augmented reality.**

BY WILL WILSON, BOEING WRITER | PHOTOGRAPHY BY MARIAN LOCKHART

**Q&A** with Boeing’s chief technologist for training and professional services.

**Q** You recently spoke at a Boeing workshop event, called **Unreal Engine Build**, with the CTO from Epic Games—what’s going on?

**A** Epic Games makes the Unreal Engine, which is a state-of-the-art, real-time 3D engine that has potential application in use cases across our whole product life cycle. It sounds a little far out, but we’re applying that capability to create some really exciting, new, immersive learning capabilities in the extended reality space. It’s an example of how we’re looking outside our industry for opportunities to accelerate and scale our development of innovative capabilities.

**Q** So, how are you leveraging extended reality for training?

**A** XR, or extended reality, is one of several key technologies that will enable us to truly transform training and learning for our industry. We’re using it to create lighter, more portable learning solutions that students can access anytime, anywhere. From tablet-based procedures and systems trainers all the way up to highly realistic, fully immersive virtual reality solutions where aspects such as muscle memory can be trained, these environments give students more control of their learning journey.

This has the potential to change the game, as the reliance on expensive, fixed training equipment becomes less of a factor. We can develop and deliver new training scenarios much more rapidly to respond to emergent needs, and we can enable more collaborative learning environments. It also opens up new possibilities for training in areas that we simply could not address in a simulated environment using traditional approaches.



### BUILDING AN UNREAL FUTURE

Pete Boeskov opens the Build: Boeing conference in Renton, Washington, in August, introducing the Unreal Engine capabilities and Boeing partnership with Epic to an assembly of technologists.

“Digital is no longer a differentiator—it’s an expectation. The next generation of crew members and technicians will expect to learn and work in different ways—mobile, connected and on-demand—that’s just how life is now.”

PETE BOESKOV

To fly and maintain the growing world fleet, we estimate that over 2.1 million new pilots, technicians and cabin crew will be required over the next two decades. This is just the civil aviation market. Our government customers face similar challenges. It’s essential that we work together as an industry to create more efficient ways to bring new personnel through the pipeline—by helping them learn more efficiently and by helping them perform more efficiently once on the job.

**Q** How else is technology changing the way we train pilots, technicians and cabin crew?

**A** Digital is no longer a differentiator—it’s an expectation. The next generation of crew members and technicians will expect to learn and work in different ways—mobile, connected and on-demand—that’s just how life is now.

We’re using mobile and web solutions to create a more connected experience for our students. Everything from registration and check-in to receiving digital learning content and delivering credentials will be integrated into one seamless experience. We’re creating a better experience and better outcomes for our customers.

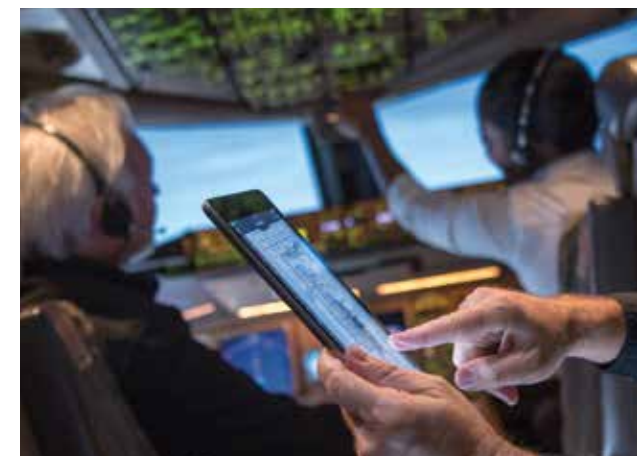

Boeing AnalytX combined with artificial intelligence will also drive significant changes. Today’s approach to training is still very much “one size fits all.” The future will be much more adaptive. We can derive tremendous insight from data collected in training and operations and use it to adapt learning to the needs of an individual or a fleet. In addition, we are creating more intelligent interfaces into the information our pilots and technicians need to do their jobs. I think we will increasingly see a shift in the industry where training is viewed as not just a means of compliance but as an opportunity to drive improved human performance.

**Q** What are some of the biggest challenges you see in bringing about technological changes?

**A** It’s easy to focus solely on the technology when thinking about challenges, and there are certainly some areas there that need further maturation. We’ll need better resolution and field of view for certain virtual reality learning applications, as well as motion cuing and the ability to provide haptic feedback. We’ll need improvements in daylight operations, field of view and the ability to anchor to real-world objects for many augmented reality learning applications. Cost and form factor are issues as well. And we’re just at the tip of the iceberg for what can be done with data analytics and AI. I’m confident these and other challenges will be addressed.





“ We will need engagement and buy-in from a broad range of stakeholders across the industry. Getting them involved early will be key to our success. ”

**PETE BOESKOV**

That said, the transformation we’re creating here is about much more than technology—it involves people, processes and culture—and this is where the real challenge lies. We’re fundamentally changing the way our customers learn and do their jobs. We will need engagement and buy-in from a broad range of stakeholders across the industry. Getting them involved early will be key to our success.

None of this will happen overnight, and we’ll need to be patient as we make the transition. We won’t eliminate the need for full-motion simulators anytime soon, perhaps ever, and initial solutions might only supplement existing training programs. These can still create significantly better outcomes for our customers, and they put us in a position to get in the game and learn together with our customers.

**Q** So when are we likely to see the first virtual reality learning solutions in the field?

**A** They’re already out there. We’ve fielded VR maintenance training solutions for our government customers and have a range of lighter-weight tablet and desktop virtual trainers for a variety of applications. That said, we’re definitely at the start of this journey. We have some exciting new capabilities in development, and we continue to measure the effectiveness of these new approaches as we explore how to integrate them into the learning experience. And, as always, we’ll continue to look across other industries like gaming for opportunities to accelerate our results. 

## Selections from the Boeing Technical Journal

The Boeing Technical Journal is a peer-reviewed periodical for Boeing subject matter experts to capture and share knowledge. Research coverage includes all manner of commercial and defense product development, and products and services spanning land and sea, to air and space, and cyberspace.

### Contributing Authors

#### Investigation of Linear Motors as Electric Actuators for Aircraft



**ERIC D. BOL** is a design engineer currently working in metal additive manufacturing technology for commercial airplanes and recently worked within product development on advanced propulsion system concepts.

#### What Is a Game-Changing Design?



**MIRIAM GRACE** is a Boeing Technical Fellow and senior systems architect supporting sales and marketing for both commercial and defense work.

The Journal is a proprietary publication, but the articles on the following pages are summaries of technical papers approved for public release and available online at Boeing.com.



# Investigation of Linear Motors as Electric Actuators for Aircraft

## Summary

BY ERIC D. BOL

Aircraft actuators are either hydraulic, pneumatic or electromechanical in most applications. This paper proposes a novel electric linear motor as a thrust reverser actuator.

Thrust reversers are not new to commercial jet aircraft and were used on the original Boeing 707 nacelles. Over the decades, they have been evolving through a variety of form factors with many patents documenting pneumatic, hydraulic and electric thrust reverser actuation methods, architectures and systems. As discussed in this paper, the concept of using linear electric motors to electromagnetically deploy and stow the thrust reverser is novel and patented by Boeing.

The thrust reverser actuation system (TRAS) is part of the fan duct/thrust reverser assembly located on the aft portion of the nacelle. All current aircraft models at Boeing power the TRAS hydraulically with the aircraft's main hydraulic system. It is normally activated upon landing by the pilots to assist with slowing the aircraft.

The thrust reverser consists of sliding cowling doors that translate aft to open the sides of the nacelle. This action also drops blocker doors into the fan duct flow path to redirect the fan flow out the side of the nacelle. The sliding cowling doors are actuated by either

four (787 only) or six hydraulic actuators per engine nacelle, as seen in Figure 2.

Recently with the Airbus A380 and A350 XWB, these aircraft use an electrically powered actuation system for the thrust reverser, commonly referred to an E-TRAS. These systems operate similarly to the Boeing hydraulic system and mostly contain the same or similar components.

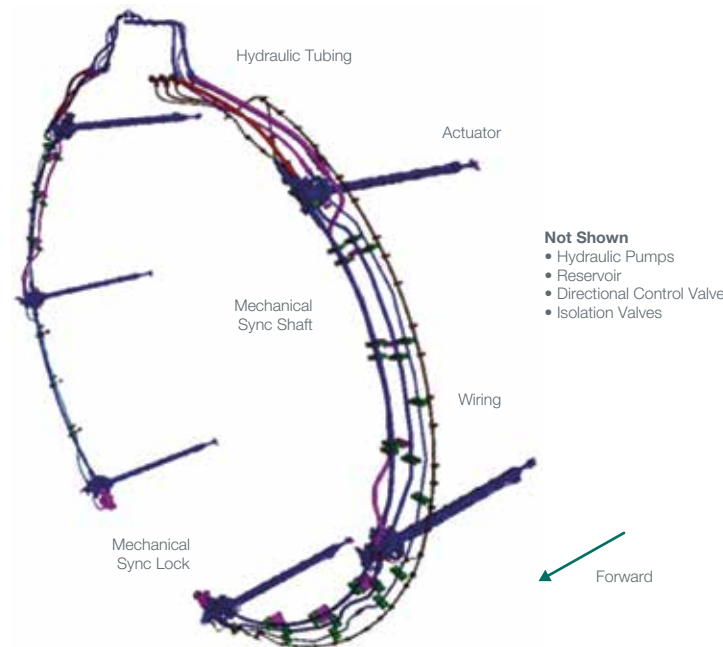

**FIGURE 2**  
Typical Thrust Reverser Actuation System layout.

Table 1 compares the individual components of the electromechanical and hydraulic systems with pneumatic and linear motor systems. Note that only the linear motor system offers a dramatic difference in components; the other systems are nearly identical. The switch from a hydraulic to electrical power source is the only significant difference between the two systems. This comparison is important because

Hydraulic TRAS	Pneumatic TRAS	Electromechanical TRAS	Linear Motor TRAS
Directional Valve	Directional Valve	Controller	Controller
Isolation Valve	Isolation Valve	—	—
Cylinder	Cylinder	Cylinder	Stator with Guide
Push Rod	Push Rod	Push Rod	Mover
Acme Screw	Ball Screw	Ball Screw	—
Integrated Lock	Integrated Lock	Integrated Lock	Integrated Lock
Fluid Tubes	Air Tubes	Wiring	(Wiring)
Transmission	Transmission	Transmission	—
Sync Shaft	Sync Shaft	Drive Shaft	—
Sync Lock	Air Motor with Brake	Electric Motor with Brake	Track Lock
Wiring	Wiring	Wiring (More)	Wiring (More)

**TABLE 1**  
Typical major component comparison list for a TRAS.

the reduction of components is usually a benefit to cost, maintenance and weight of a system.

A vast majority of electric actuation technologies used in the aircraft industry to create linear motion are of the electromechanical type. This is where an electric rotary motor turns a transmission that turns a screw or a rack to move a push rod.

That motor takes electrical energy and converts it to kinetic energy in the form of rotational motion, which then must be mechanically converted to linear motion. There are inherent energy friction losses and wear that result from this conversion. A linear motor is often referred to as a direct-drive motor because the electrical energy is converted directly to linear motion without a mechanical transmission, as shown in Figure 5.

Since linear motors operate under the same laws and controls as rotary motors, synchronous, induction and switched reluctance motor technologies are applicable. A key question that this study answered is: Which motor technology would be preferable as a thrust reverser actuator?

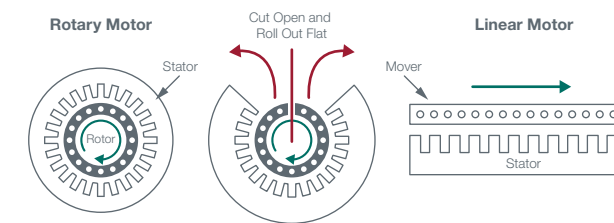

**FIGURE 6**  
Simplified visualization of rotary versus linear motor.

Linear motors are complex electrical machines but are mechanically simple with two main parts: the translating mover and stationary stator.

As shown in Figure 6, a mover translates past the stator without making physical contact. The mover can be simply supported by a slider track or guide rail. Thrust reversers already have sliders and guide tracks, so there is potential to design an integrated motor actuator into the existing structure. This can mean fewer parts to build, install and maintain. The simplicity of the mechanical operation and the lack of a friction drive can directly translate to less wear and tear on the structure over time.

Three different types of linear motor actuators were designed using synchronous, induction and switched reluctance technologies. The designs were analyzed for performance and controllability, and assessed for manufacture and nacelle integration impacts.

The study showed that the double-sided, linear induction motor is an attractive technology. However, with the zero-torque-at-stall issue, an internal permanent magnet/flat linear brushless motor may be a viable alternative for a thrust reverser actuation system. The linear switched reluctance motor technology was ruled out during the study.

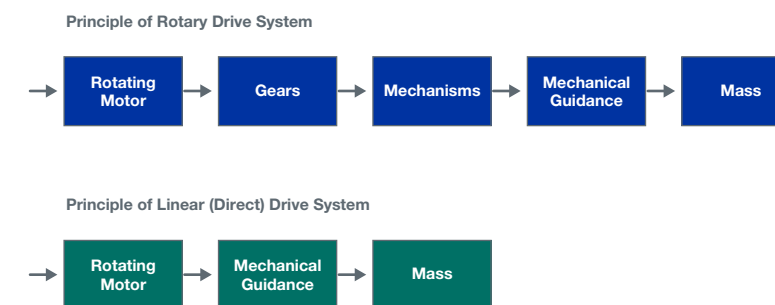

**FIGURE 5**  
Comparison between an electromechanical and a linear electromagnetic (direct) drive system.

### Linear Synchronous Motor Actuator

The Linear Synchronous Motor was designed by Won-Jong Kim and his grad student, Young Shin Kwon, at Texas A&M University.

Great effort was put into qualitatively evaluating the current state of the art in order to determine the optimum motor architectures to further analyze. Even within the linear synchronous motor design space there are many architecture configurations to choose from, such as a flat or tubular shape, double or single stator, slotted or slotless, and mover core with internal or surface mounted magnets.

As shown in Table 2, the options were narrowed to five different configurations with the most potential to meet the performance and weight requirements, which were then designed, evaluated, and compared:

- Two tubular linear synchronous motors (TLSM) with either internal (IPM) or surface (SPM) mounted permanent magnets.
- Two flat linear synchronous motors (FLSM) with either IPM or SPM.
- One flat linear brushless motor (FLBM) with IPMs.

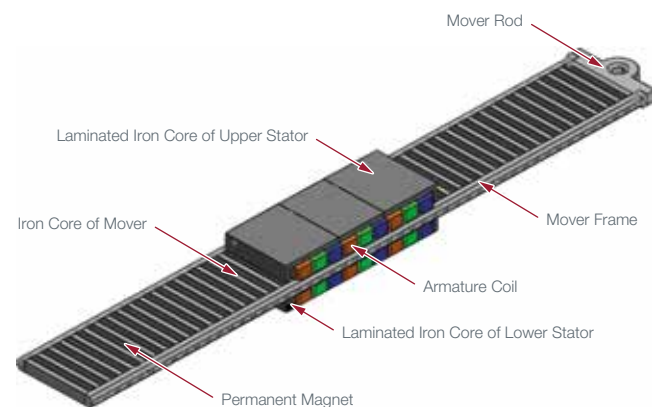

**FIGURE 9** Design for an internal permanent magnet-flat linear brushless motor (IPM-FLBM) actuator.

Of the five synchronous motors analyzed, the configuration with the best thrust force per ampere-to-weight ratio was the double-sided IPM-FLBM where the mover (translating rotor) was sandwiched between two fixed stators. The actuator design is depicted in Figure 9.

The IPM-FLBM actuator controller contained a position and speed controller with independent feedback loops. A simulation was built to input the TRAS load stroke curve as the external disturbance force and measure the response as the motor deployed.

In addition to the design of the motor and controller, a MATLAB program with a graphical user interface was

built as a linear motor design tool. The program uses linear equations to predict the performance of the motor in order to save computational time, and those equations are supported by finite element models. With the program, the motor can be redesigned and resized to fit different applications that a user might require. In addition, a parameterized controller simulation was built using Simulink to take a motor design and predict its response with a custom external forcing function such as a TRAS load stroke curve. The external forcing function can also be changed to test the response in different applications.

There is some apprehension regarding whether a permanent

magnet actuator would survive in a nacelle environment. The biggest challenges for this motor technology and design would be the reliability, operability and manufacturability. For the permanent magnets specifically, the key reliability concerns are temperature and vibration.

### Linear Induction Motor Actuator

The linear induction motor was designed by Boeing Senior Technical Fellow Robert Atmur and his team. Atmur has extensive experience in designing induction motors and has programmed sizing tools for optimization. The architecture of this motor design in Figure 12 consists of a three-phase AC double-sided linear induction motor, commonly known as DLIM, where the mover is also sandwiched by two fixed stators.

To control the linear induction motor actuator, a novel controller was devised. Technical Fellow Ashwani Chaudhary was responsible for building the controller simulation. The initial electrical simulations showed a stable controllable system was feasible regardless of whether a large or small magnitude step command was input. The resulting simulated actuator was able to deploy in 0.5 seconds, hitting

Three different types of linear motor actuators were designed using synchronous, induction and switched reluctance technologies. The designs were analyzed for performance and controllability, and assessed for manufacture and nacelle integration impacts.

a peak velocity of 7 m/s in about 0.1 seconds and spending the remaining 0.4 seconds coming to a controlled stop. In this case, however, due to time constraints a more accurate motor model was unable to be included in the simulation to substantiate the calculated peak electrical loads. During standard operation it was determined that the peak electrical load would be 47 kW; however, a problem was discovered that when the actuator is at stall speeds (zero velocity) the power required would be greater than 141 kW per actuator. This would be a higher load than the aircraft electrical power system can accommodate. A means to provide initial motion would significantly reduce that load.

What makes the DLIM attractive is the actuator simplicity and its thrust-to-weight capability. This actuator design would be fairly easy to integrate with the thrust reverser because it contains no permanent magnets, and the triple thyristor controller is simpler.

In a thrust reverser actuation application, the motor is not in operation for a long enough period of time for heat rejection to be an issue; the temperature rise was calculated to be very small at less than 10 degrees Celsius. The biggest challenge to integration would be the added mechanism needed to provide motion when stalled so as to prevent the unmanageable electrical load. A solenoid or spring could be

Tubular Linear Synchronous Motor (TLSM)		Flat Linear Synchronous Motor (FLSM)		Flat Linear Brushless Motor (FLBM)
Surface Permanent Magnets (SPM)	Internal Permanent Magnets (IPM)	Surface Permanent Magnets (SPM)	Internal Permanent Magnets (IPM)	Internal Permanent Magnets (IPM)
SPM-TLSM	IPM-TLSM	SPM-FLSM	IPM-FLSM	IPM-FLBM

■ Magnet ■ Iron ■ Three-Phase Copper Coils

**TABLE 2** Linear synchronous motor design configurations for optimization.

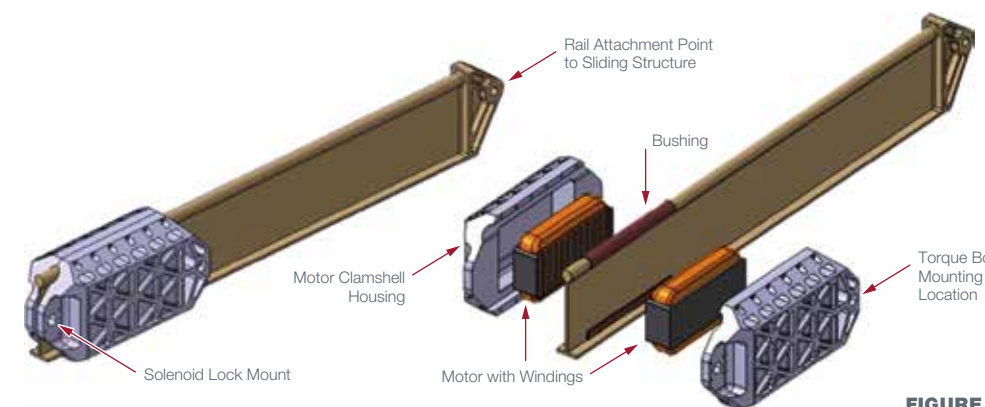

**FIGURE 12** Design for a double-sided linear induction motor (DLIM) actuator.



integrated into the actuator design in order to provide some small impulse when the mover velocity is at zero. Or the sudden high demand could be managed by a bank of capacitors, though initially that solution appears to be heavy, which is not appealing for aircraft applications.

**Linear Switched Reluctance Motor Actuator**

Like the linear synchronous motor, the linear switched reluctance motor (LSRM) was designed by Texas A&M University's Won-Jong Kim and Young Shin Kwon.

This part of the study analyzed four different architectures of switched reluctance motors. There was a longitudinal-flux tubular (LF-T) LSRM, two longitudinal-flux flat (LF-F) LSRMs with either iron or a mix of iron and nonferrous materials, and a transverse-flux flat (TF-F) LSRM, each qualitatively assessed to have the highest force output compared to other architecture options.

In terms of integration with a thrust reverser on a nacelle, the LSRM configuration, similar to the DLIM, benefits from not containing permanent magnets. Manufacturing of the LSRM would be more costly than the DLIM, since there will be more poles to machine and coils to wind, but still likely cost less than the IPM-FLBM.

To output the required load, however, the TRAS would need six actuators per nacelle, which results in an

unacceptable weight. Further, the amount of unsupported length stowed over the fan case would be a problem in a nacelle environment where high vibration loads are common.

Table 3 compares the thrust-to-weight and thrust-to-power ratios of the three studied linear motor actuators, where the DLIM design stands out as the highest performer.

It is important to note that the IPM-FLBM and the DLIM were both

able to meet the thrust force needed within the design volume restrictions.

This article recommends further model-based analysis, prototyping and lab testing of the IPM-FLBM and DLIM actuators. Prototypes and tests would validate the design, analysis, control, manufacturability and operability of the actuators to advance their technology readiness level. **IQ**

Actuator	Thrust (lbf)	Weight (lbm)	T/W Ratio (lbf/lbm)	Power (kW)	T/P Ratio (lbf/kW)
IPM-FLBM	3,400	90	37.8	22.6	150.4
DLIM	8,200	62	132.3	47	174.5
LF-FLSRM	2,140	83	25.8	25.5	82.9

**TABLE 3**  
Comparison of the three linear motor actuator designs.

To read and download the complete Boeing Technical Journal paper titled:

“Investigation of Linear Motors as Electric Actuators for Aircraft”

Please visit [boeing.com/IQ](http://boeing.com/IQ).

# What Is a Game-Changing Design?

## Summary

BY MIRIAM GRACE

In the beginning was the link. This simple and yet profound disruptive technology of the internet moved us into the world of virtual relationships and forever changed the accepted organizational form. The web transformed traditional business boundaries from impenetrable firewalls to semipermeable membranes that struggle to control an inherently uncontrollable phenomenon—human-to-human interchange.

The internet was clearly a game-changing design that employed new technology breakthroughs that transformed traditional business practices. There are strong indications that the next horizon of game-changing designs will represent radical shifts in how people think about and perform their work. This economic survival game of keeping ahead of competitors has become much more knowledge driven.

What employees know, and discovering ways to enable them to work together to grow that knowledge into competitive advantage, is the next frontier.

What has been referred to as “discontinuous change” in business contexts increasingly asks: What actually are the viable differentiators in today’s global business environment? What enables a company to continually reinvent itself? What are examples of

game-changing strategies that will disrupt business-as-usual enough to shift outmoded paradigms?

A lesson from the world of education might apply here. In doctoral research, there are both quantitative and qualitative paths to knowledge. Perhaps we could apply that model to the world of business and combine the institutionalization of a design culture (a qualitative value) with competitive analytics that serve fact-based decision-making (a quantitative value).

A balance of these models, supported by a robust learning infrastructure and a deep understanding of systems and their dynamics, might prove to be a strategy disruptive enough to our established organizational forms to allow us to escape the groove we find ourselves in and strike out in new directions.

Through data analytics today, organizations are gaining new insight into areas of leverage and potential advantage in a particular competitive arena. An integrated system of explanatory and predictive analytics structured through dynamic simulation and scenario planning strategic analysis is a powerhouse of knowledge acquisition tools.

Clearly, we’re drowning in data. We have data about data about data (meta-metadata). Data is straining the capacities of our databases and repositories. But the critical data, the data that gives us a competitive edge, is difficult to identify.

The ability to mine and exploit data is actually quite a recent phenomenon. As computing power grew exponentially, the marriage of analysis, graphic images and massive data volumes became feasible.

Business intelligence has been identified as the No. 1 priority for IT organizations. Companies that have moved beyond data mining and management to quantitative and qualitative analysis and visualization techniques integral to the corporate strategy are exploiting knowledge for competitive advantage.

## Creating a Design Culture

The pace and intensity of creating and sustaining a design culture requires integrated design teams and other collaborative forms of team structure that are themselves designed. Members of a design team must be carefully chosen for the qualities they bring and should be assessed against criteria such as their characteristics in the following nine areas.

### Cultural competence

Cultural competence is the knowledge, skills and attitudes that are required to engage in and carry out mutually satisfying cross-cultural and cross-gender (or other) encounters or dialogues across differences. Collaboration skills allow team members to participate, learn with others, and share, in both word and graphic language, thoughts and ideas that are essential to design action.

### Judgment

Judgment is the ability to apply wisdom, set and solve ill-defined problems that have multiple sets of interdependent variables (complexity), and learn from consequences, as opposed to an ability to make decisions and solve well-defined problems.

### Empathy

Empathy allows us to project ourselves forward into the experiences of others in order to gain insight and enable the interpretation of intangible meaning in what others say and do.

### Creativity and innovation

Design is inclusive of creative thinking and includes innovative activity, which applies creative concepts to real-world situations.

### Tolerance for ambiguity

Tolerance for ambiguity is an embrace of uncertainty and acceptance of complexity.

### Positive attitude toward error

Seeing error and failure as sources of learning encourages risk-taking and exploration of possibilities.

### Bias toward service and responsibility

Bias toward service and responsibility is a view of organizational life as an act of ethical composition on behalf of oneself and others.

### Contextual awareness

Contextual awareness is a partner with cultural competence. Without deep awareness of the context in which one is operating, design collaboration cannot occur.

### Systems thinking

Systems thinking is a holistic approach to understanding complex relationships and their feedback behavior, and it is characterized by intentional reflection in, and on, action. It represents the habit of mind that looks for the often hidden patterns of interconnections and interactions that operate among the people, processes, structures, functions, information and technologies within a particular contextual space.

To change the game, we have to look through to the skeleton of values that supports the corpus, study the interconnections, and look to the revealed trends and patterns to understand what holds the whole structure in place. When we see this deeply into a phenomenon, we can begin to influence it, but this requires a powerful will and a sustaining vision.

A desire for increased market share won't support this kind of long-term strategic direction shift. If we are looking to change the game, leadership must design a vision that will address the whole system and the hidden connections.

Boeing business leaders already hold up continuous learning as a foundational corporate strategy that assists us in the ongoing shift from bounded organizational views to a whole systems paradigm.

To be knowledge-driven may mean that having to know more is a business imperative. But knowledge alone won't fast-track us at the speed we need to travel. A knowledge incubator is needed—an organizational and contextual hothouse for growing that rarest of flowers, which is sustainable success.

Through data analytics today, organizations are gaining new insight into areas of leverage and potential advantage in a particular competitive arena. An integrated system of explanatory and predictive analytics structured through dynamic simulation and scenario-planning, strategic analysis is a powerhouse of knowledge acquisition tools.

These tools can not only be turned on to out-know the competition about a particular technology or product direction, but also can be leveraged toward revenue generation. Knowing the customer, being able to provide

customers with critical predictive information on, for example, elements that disrupt their income stream, not only enhances the customer relationship but can, in some instances, be offered as a new product line.

The idea of design thinking may be the single most important business concept to emerge from the 20th century. Design thinking is a perfect complement to the earlier efficiency movement. While the scientific method of management, espoused by Frederick Taylor and later refined by Joseph Juran and Peter Drucker, provided a key framework for how work should be done, design thinking answers what, as well as why, a given thing should be done.

In 1996, on the 100th anniversary of the New York Stock Exchange, it was noted that of all the original companies that had started up the Exchange, only General Electric had survived. This speaks to the fragile nature of business sustainability and to the imperative for a company to know “why” they are in business (a design question).

## Whole Systems Design

Whole systems design is the expression of the composition of design and the systems sciences. It is the intentional creation of wholes, the antithesis of the fragmented, silo-like thinking that is at the heart of so many of our modern-day business and social problems.

Whole systems design is a process of intentional leadership. The outcome is the shaping and influencing of a composition that has never existed before. It is an emergent process that is always collaborative, most effectively performed within a diverse design team, and whose properties arise from the interrelationships of the essential elements (people, processes, structures, information and technologies). A whole systems designer's focus is on the creation of resilient systems that express the art of making things that fit harmoniously in their context.

But the game keeps changing, and game-changing strategies have to be aware of, and work with, this natural systems oscillation. We have to keep in mind that humans don't learn much from success. When we are successful, we tend to keep doing what we have been successful doing. Yet, experientially, we know that the deepest learning emerges from failure because the shock of failure triggers us to shift our thinking, which leads to different behavior and tends to reverse the failure spiral.

A focus on the cultural element inherent in all human activity allows design-conscious leaders to set a design agenda that is sustained

through a design culture and continuously renewed through a systems approach to knowledge creation.

The ability to manifest an idea that fulfills a critical need is the alchemy sought by a knowledge-driven corporation. This capability, combined with making significant improvements to existing products, processes or services, is what constitutes true innovation.

Design is disciplined inquiry. What works in opposition is the culture and complexity of contemporary corporate organizations that are often disincentivizing to those working to make the shift from the era of the

PHOTO: GETTY

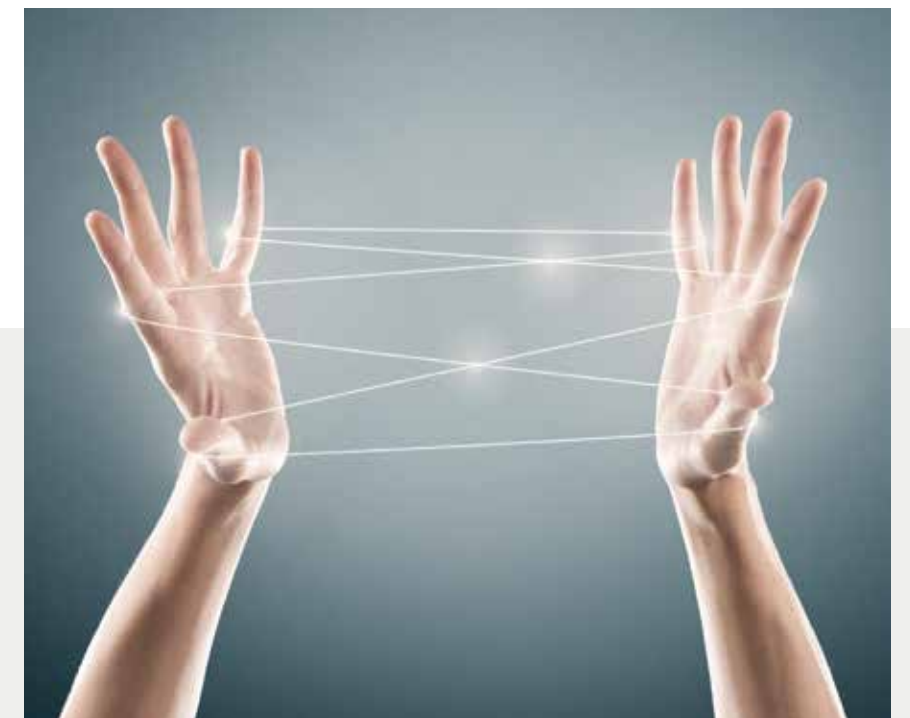



## Changing the Game

The following disruptive strategies are offered as “game-changing” interventions that companies can adopt to begin to cope with 21st-century knowledge-creation challenges:

- Synergize the corporate culture with design principles and practices.
- Adopt and proliferate a deep understanding of systems and institutionalize systems thinking.
- Catalyze radical change readiness through peer-to-peer apprentice style mentoring and partnering.
- Maximize understanding, visualization and strategic use of competitive analytics.

This package of complex, interdependent strategies is not an easy undertaking. Even as we attempt to change the game, the game itself is altered. To change the game, the underlying structures must be fundamentally changed. What holds today’s corporate and civil institutions in place are the connections—one person with another, one culture with another and one idea with another.

expert individual to an integrated and collaborative team working together through a knowledge-creation paradigm. The context where knowledge synthesis is intentionally nurtured to maturity is referred to as a “design culture.”

The idea of a culture of design within an organizational context to foster design reasoning, judgment and practice emerged along with the discussions of the learning organization. Design is an intentionally directed process that motivates individuals to collaborative action and helps to eliminate elements of human interaction that drain energy and human potential. A focus on deep and continuous learning ignites this potential within the conducive containing environment of a design culture.

The ability to mine and exploit data is actually quite a recent phenomenon. As computing power grew exponentially, the marriage of analysis, graphic images and massive data volumes became feasible.

The combination of a design culture that relentlessly pursues innovation and creativity and the use of strategically driven analytics is a powerful and dynamic duo. Examples of the high value that analytics can bring to a business include measuring the impact of marketing strategies, predicting customer behavior, analyzing historical trends, anticipating future fluctuations in the marketplace, or helping a customer understand and manage disruptions to their value stream.

A core value of continuous learning as a leadership imperative, supported by the deep learning achievable through peer-to-peer, apprentice-style mentoring—especially in leading edge technology areas such as analytics—sets in motion a self-organizing and self-sustaining engine of productivity. 

To read and download the complete paper, originally published in the Boeing Technical Journal in 2013, titled:

“What Is a Game-Changing Design?”

Please visit [boeing.com/IQ](http://boeing.com/IQ).

# Patent spotlight

Check out a few of Boeing’s latest ideas and technical breakthroughs recently granted or published by the U.S. Patent and Trademark Office.

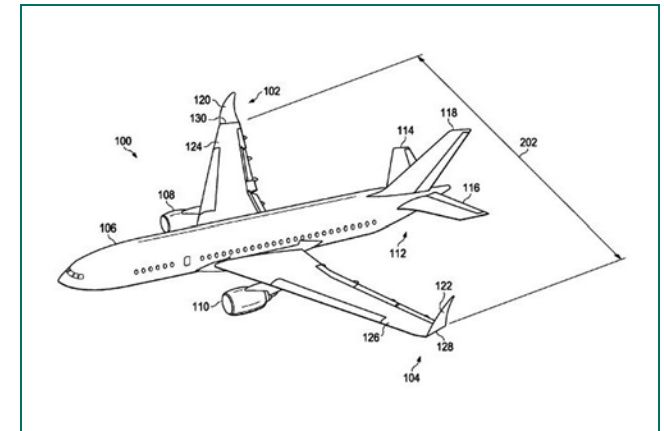

## Wing Fold Controller

**U.S. PATENT: 9,499,252**  
**INVENTORS: MATTHEW AUGUST LASSEN, MARK STEVEN GOOD**

Efficient aircraft configurations are increasingly important as fuel costs continue to rise. Larger aircraft and aircraft with larger wingspans tend to be more fuel efficient. However, most airports were not designed with adequate space to accommodate modern aircraft with longer wings.

Military and future commercial aircraft both utilize folding wingtips, which allow an aircraft to have a long wingspan while in flight and then have a shorter wingspan when on the ground. Both of these types of aircraft will benefit from a smaller, lighter folding actuator and wing structure, which could be made possible with closed-loop load control.

This patent describes a system configured to limit a force at the wing fold actuator output. Decreasing the loads on the actuator that folds the wingtip allows for a lighter system and structural design, and it increases the time before the actuator requires maintenance. Reduced loads imparted by the system onto the wing structure also prolong the fatigue life of the structure and reduce inspections that need to be performed on the wing structure by an airline.

Because of the folding wingtip, longer-winged aircraft can fly into airports without requiring any gate or runway modifications. This is one of several Boeing patents for folding wingtips, a unique and innovative feature of the upcoming 777X that is expected to enter into service in 2020.

## Scientific and Technical Publications | 2017

NUMBER OF PUBLICATIONS, THOUSANDS

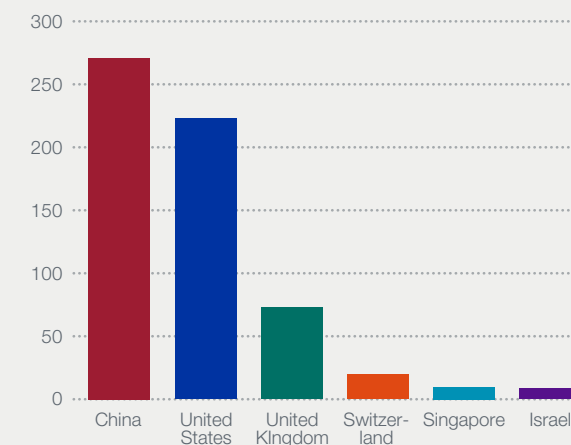

### GLOBAL THOUGHT LEADERSHIP

Above is a sampling of nations’ intellectual knowledge output. Large, high-income economies and China lead all others in absolute innovation performance, according to findings from the 2018 Global Innovation Index, co-published by Cornell University, INSEAD and the World Intellectual Property Organization, a specialized agency of the United Nations.

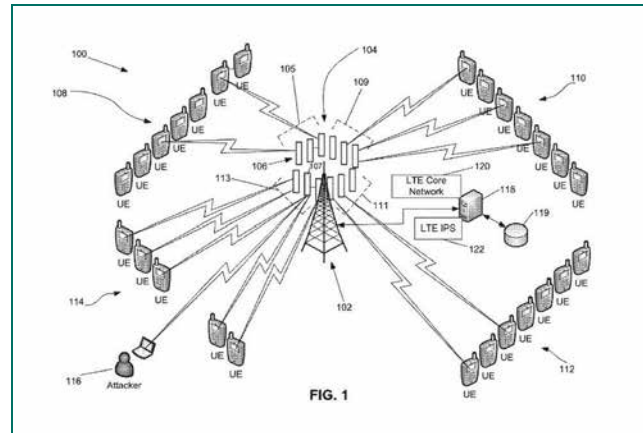

## Method and System for Wireless Attack Detection and Mitigation

**U.S. PATENT: 10,075,850**  
**INVENTOR: BRIAN J. SMITH**

Wireless services are convenient and efficient, and have facilitated communication immensely. However, the openness and exposed nature of wireless networks make them more vulnerable to various types of attack, such as a denial-of-service (DoS) attack. Wireless networks have security protocols, but no system is invulnerable. An attack detection or mitigation method is needed that can respond to emerging attacks without reliance on protocol security enhancements, which can be costly and prolonged.

A DoS attack happens when an attacker prevents legitimate users from accessing the network, for example, by bombarding the network with illegitimate traffic, thus interfering with valid wireless transmissions. This patent describes a method for attack detection and mitigation by using antennas in different directions of coverage. An intrusion prevention processor or device would analyze incoming signals and determine individual or aggregate device behavior patterns that indicate if an anomaly has occurred. Attacking signals are then blocked using the antennas in the direction of the anomaly, enabling the remainder of the system to stabilize.

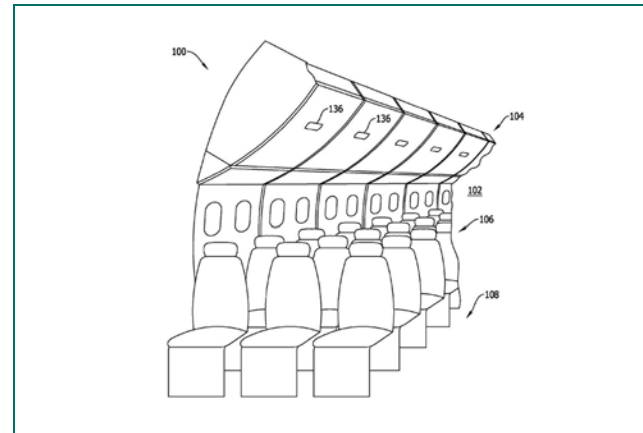

## System and Method for Allocating Objects Within Storage Bins

**U.S. PATENT: 9,869,574**  
**INVENTOR: ERIC NICKS**

Modern flights are almost always fully booked, leaving little available overhead storage space and stressed passengers who can't find anywhere to place their bags. This recent addition to the Boeing patent portfolio, however, offers hope.

This patent describes an object allocation system and method for determining and monitoring available capacity within overhead storage bins to facilitate the most efficient use of bin space. This system comprises storage bins with motion sensors and a profile sensor that would determine available capacity within the bins. A controller determines the boarding status of the aircraft, activates the sensors, and not only transmits an indication of the availability of space within the first bin but also determines the shape of the luggage already in the bin. Providing the shape of the luggage helps give a rearrangement recommendation among bins to ensure the most efficient use of space. A display device such as an LED light on the outside of the bin indicates fullness.

Such a system enables passengers and flight crews to quickly determine the location of available overhead storage space during boarding. This system could reduce both boarding delays and passenger frustration.

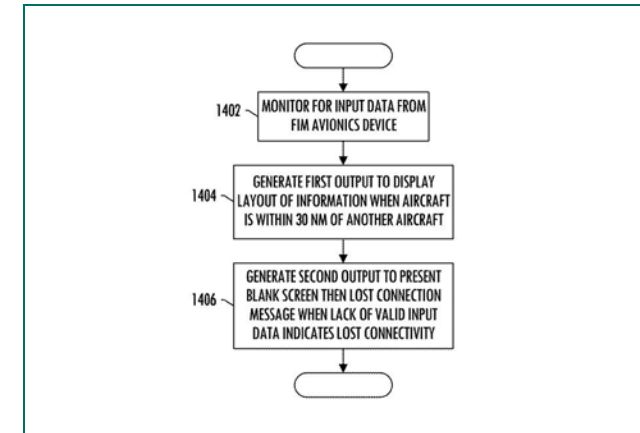

## Display of Flight Interval Management Data

**U.S. PATENT: 10,074,282**  
**INVENTORS: GEORGE WILBER**

Flight interval management (FIM) refers to the management of the spacing between aircraft in flight. Generally, FIM operation includes the instruction to the pilot to achieve or maintain a desired spacing (in time or distance) from another aircraft.

This recently granted Boeing patent describes a system to provide FIM instructions through a new module in the flight deck. When the module receives input that the subject aircraft is within 30 nautical miles of another relatively spaced aircraft, it generates an output displaying, at minimum, a paired mode of the module with the FIM avionics device, and a commanded speed reported by the FIM avionics device.

This system also includes specific flight safety provisions, which generates a blank screen instead of previously displayed data that might mislead the pilot. The display would message that the connection with the FIM avionics device has been lost.

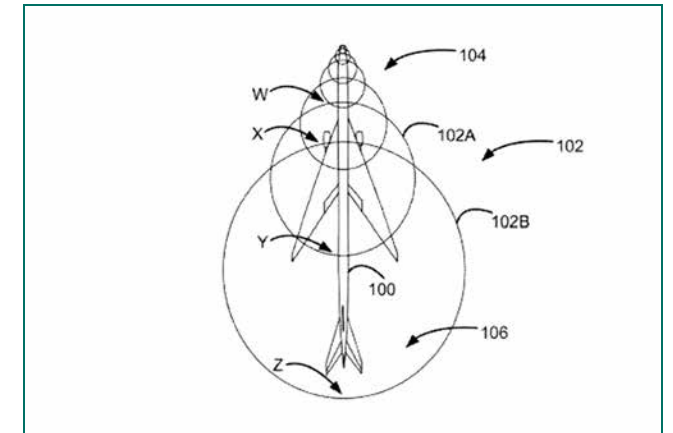

## Apparatus and Method for Reducing a Sonic Boom Signature

**U.S. PATENT: 10,093,411**  
**INVENTORS: ERIC E. ADAMSON, DAVID A. TREIBER**

A sonic boom is awe-inspiring but disruptive. Due to the extreme levels of noise heard on the ground as the result of the sonic boom, FAA regulations currently prohibit any commercial supersonic flight over land. Aircraft are thus required to fly at lower speeds, prolonging travel time.

The sonic boom is actually two booms—one when the initial pressure rise from the nose hits, the other when the tail passes and the pressure suddenly returns to normal. The power of the shock waves is dependent on the quantity of air that is being compressed, accelerated and recompressed and thus is dependent on the size and shape of the aircraft.

This new patent describes a method for reducing a sonic boom signature of an aircraft by using an interference body that is attached to the aircraft aft of the wings. The shape of the interference body is tailored to interfere with the compression wave coming off the aircraft and thereby reduce the sonic boom.

A significant noise reduction that results in an acceptable level of noise on the ground could prompt a revision of the regulations that currently prohibit supersonic overland flight.



# Computer vision in China

## A collaborative effort in machine perception research aids airplane inspection.

BY ALLY (YING) LIU, ELECTROPHYSICS ENGINEER | ELISABETH MARTIN, AEROSPACE ENGINEER | FONG SHI, TECHNICAL FELLOW

China is rapidly becoming the largest aviation market outside the United States. According to Boeing forecast, China's aviation industry needs at least 5,000 airplane technicians each year for the next 20 years. However, given that it takes five to seven years to train an airplane maintenance technician, a shortage of qualified airplane technicians becomes inevitable; on current trends, only 3,000 might be licensed.

An automated system to assist maintenance inspection could help mitigate this challenge in technician training and represents a significant business opportunity for aviation services.

The rapid development of combining immersive technologies such as augmented reality (AR) with artificial intelligence is now enabling computer vision-based applications, also known as machine perception technology, that could play an important role in airplane ground inspection.

Aiming to improve airline operation efficiency and support business development in aviation services, Boeing researchers have been collaborating with research partners from Chinese universities to develop an automated system for airplane inspection. Computer-vision research and development efforts across China have achieved major progress in recent years, driven by a need for practical applications such as this in light of the country's aviation system growth.

At the front-end image capturing stage, ground crews may scan an airplane with an AR headset along with other necessary hardware, and capture images of all possible regions

of an airplane. Captured images are transmitted to a back-end processing platform where computer-vision techniques are deployed to identify if certain abnormalities exist.

To achieve detections with higher accuracy, state-of-the-art computer-vision architectures and algorithms of deep neural networks are being designed and developed to recognize and analyze the captured airplane images to identify anomalies and initiate early warnings. Furthermore, for the purpose of training computers through intelligent machine learning, over 20,000 airplane images containing damages of various types have been collected.

Applying automated detection for a comprehensive airplane inspection—including airplane crown, tails and components that are hard to reach—will also facilitate shorter aircraft turnaround times on the ground.

Boeing's research center in China—established in 2009—has research collaborations with 35 major universities, 21 national institutes and 24 industrial partners in China as of 2018, making it a nexus of research, development and innovation for the Chinese research community.

Computer-vision-aided airplane inspection is an example of one of the research applications advancing with this effort, creating practical technical solutions for the burgeoning market. 



PHOTO: BOEING

## Global Scale

### Boeing's first factory in Europe opens in Sheffield

Boeing's first European factory opened in Sheffield, U.K., in October (pictured above). Each month, it will produce 10,000 actuation system components for the 737 and 767 passenger jets. These actuator components—mechanical devices that move or control mechanisms like wing flaps and landing gear—will be shipped to Boeing's Portland, Oregon, fabrication plant before heading to final assembly factories in Washington state. Sheffield has been the home of the Advanced Manufacturing Research Centre, a collaboration between Boeing and the University of Sheffield, since its founding in 2001.

### Autonomous synchronized flight tests in Australia

In Queensland, Australia, in August, Boeing completed synchronized unmanned aerial vehicle (UAV) flight tests without input from a human. The UAVs in this test featured an on-board command and control system—developed in Australia—that automatically perceives, processes and reacts in coordination with other unmanned vehicles. The system has potential for civil, commercial or defense application in air, land or sea environments. This project has been delivered in partnership with the Queensland government as part of Boeing's Advance Queensland Autonomous Systems Platform Technology Project.

### Japan's flight plan for future air mobility

Japan's Ministry of Economy, Trade and Industry has created a Public-Private Conference for Future Air Mobility; the effort aims to relieve traffic congestion, improve mobility for people in remote areas and aid disaster relief. The project brings together government agencies and companies, including Boeing, to examine the technologies and regulations necessary for the commercialization of air mobility services.

### Airplane Inspections Enhanced by Augmented Reality and Deep Learning

GRAPHIC: BOEING



AR Glasses



Wireless Network  
802.11b/g/n



Deep Learning Algorithm  
for Damage Detection

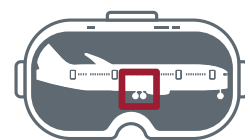

Terminal 1: AR Glasses View



Terminal 2: iPad View

#### SYSTEMS ARCHITECTURE

- Capturing images of airplanes with an AR headset
- Employing deep learning techniques to identify anomalies and initiate early warnings
- Transmitting the captured images wirelessly to a back-end workstation







PHOTO: BOEING



PHOTO: MATT HAGEN/UNIVERSITY OF WASHINGTON

Spreading  
the word to  
change  
the world



PHOTO: BOEING



PHOTO: BOEING



PHOTO: BOEING

**From the top, left to right:**

**CHANGE = OPPORTUNITY**  
Gena Lovett, a vice president from Boeing Defense, Space & Security, speaks alongside other technical leaders at a Women of Color STEM event in Detroit in October.

**LEARNING TO FLY**  
Boeing Chief Technology Officer Greg Hyslop shares a light moment while celebrating the 100th anniversary of aerospace education at the University of Washington's William E. Boeing Department of Aeronautics and Astronautics in October.

**AWARD-WINNING IN AUSTRALIA**  
General Angus Campbell, chief of the Australian Defence Force, visits the Boeing exhibit at the Land Forces conference for a demonstration of the Currawong Battlespace Communication System, which was named one of the best projects in the country at the Australian Engineering Excellence Awards.

**SILVER SNOOPY IN CALIFORNIA**  
Boeing Associate Technical Fellow Creed Blevins (second from left) was presented with the coveted NASA Silver Snoopy Award in September. The prize is given only to non-astronauts for critical contributions to the safety of the space program. Boeing Starliner astronaut Chris Ferguson and NASA astronauts Eric Boe and Nicole Mann presented the award, which includes a Snoopy pin that has been to space and back.

**GEEKING OUT IN SEATTLE**  
Senior Technical Fellow Paul Dodd was part of a team of Boeing technology ambassadors at the GeekWire Summit in Seattle in October. Participants were offered the virtual reality experience of docking the Boeing Starliner to the International Space Station.

Servicing  
the Aircraft  
from the Very  
Beginning

# How we keep the world flying

More than a century ago, when William Boeing founded Pacific Aero Products, he understood that his company would be continually introducing the world to machines so new that there would be no one to repair, maintain or teach people how to use them.

So, those services would naturally have to be part of the business.

This vision was included in the company's articles of incorporation, which had provisions not only for manufacturing airplanes but also "to act as a common carrier of passengers and freight by aerial navigation ... operate schools of aviation, and for teaching of all branches of knowledge and of the arts and sciences in any way connected with or useful to the operation of aeroplanes."

Throughout the following decades, Boeing has provided these services and more to both defense and commercial customers around the globe. And in 2016, 100 years after the company was established, Boeing announced it would form a new major business by integrating the services capabilities of the defense, space and commercial sectors into a single, customer-focused organization. Operating as a third business unit, Boeing Global Services provides agile, cost-competitive services to commercial and defense customers worldwide. [IQ](#)

—CANDACE BARRON AND MIKE LOMBARDI



PHOTO: BOEING

**ON THE FRONT LINES**

In this 1944 photo, Boeing field service representative Ken Hamner is in Italy to support U.S. 15th Air Force B-17s.



PHOTO: BOEING

**SIDE BY SIDE IN NORTHERN IRELAND**

Mechanics and technicians like Boeing's Flan McMahon, who works in Dublin, provide expertise and support to airline customers wherever and whenever they need it.



# BUILD THE FUTURE OF FAST

F/A-18 Super Hornet



With Boeing, you'll have tools and support, and we'll take your career development seriously. When can you start?

[boeing.com/careers](https://www.boeing.com/careers)



Boeing is an Equal Opportunity Employer. Employment decisions are made without regard to race, color, religion, national origin, gender, sexual orientation, gender identity, age, physical or mental disability, genetic factors, military/veteran status or other characteristics protected by law.

 **BOEING**