

Innovation Quarterly

A woman with long blonde hair, wearing a black motorcycle jacket with red and white accents, blue jeans, and black boots, stands next to a red and white motorcycle. The motorcycle is parked on an airfield with a control tower visible in the background under a clear sky.

2019 Winter
Volume 3, Issue 11

Industrial Champions

Multiskilled engineering
to optimize performance

Industry 4.0

The future of building

ISS: 20 Years Strong

The marvel of humanity
manufactured on orbit

PUBLISHER

Greg Hyslop
Boeing Chief Technology Officer

ASSOCIATE PUBLISHER

Peter Hoffman
VP Intellectual Property Management

EXECUTIVE ADVISORY BOARD

Heidi Capozzi, Todd Citron, Ted Colbert,
John Hamilton, Lynne Hopper,
Naveed Hussain, Gary Wicks

EDITOR

Candace Barron

DEPUTY EDITOR

Junu Kim

CONTRIBUTING EDITORS

Will Wilson, Patrick Summers,
Robin McBride

GRAPHICS AND

DESIGN EDITOR

William Crane

DESIGN TEAM

Kim Proescholdt, Clayton Chu,
Carlin Ng, Kevin Mau, Vaughn Hale,
Bruce Burton, Jessica Paladini,
Teresa Stanker, Mark Thibodeaux

DIGITAL TEAM

Conan Kisor, David Parke

PATENT SPOTLIGHT

Melanie Morrill

BOEING TECHNICAL JOURNAL

Ken Hardman, John Adrian, Gary Ray

TECHNOLOGY INTELLIGENCE

AND TRENDS

Marna Kagele, Will Wilson

LEGAL ADVISOR

Tom Donahue

COMMENTS

Comments and letters are welcome and
may be published in subsequent editions.
To submit a letter to the editor, email
candace.k.barron@boeing.com.

WEBSITE

boeing.com/IQ

ON THE COVER

Lauren Heisey is an industrial engineer
working in Ridley Park, Pennsylvania.

PHOTOGRAPHY BY FRED TROILO

Featured

12 | Innovation inside and out

Industrial engineers, who specialize in everything from production to design optimization, are some of the most versatile technologists in the business. And the people who become IEs, like Lauren Heisey, at Boeing's Philadelphia site, are as multitalented in their personal lives as they are at work.

28 | Industry 4.0 ready

Boeing's newest factory is also its most advanced. The fabrication plant in South Yorkshire, U.K, is ready for the Fourth Industrial Revolution and will be prepared to incorporate the newest production processes and equipment as they are developed and introduced into the industry.

40 | Machines learning to automate better

Data scientists and production engineers in Boeing South Carolina work together to apply artificial intelligence technologies to an advanced system of production automation.

Technical Papers

32 | Model and Analysis of an Active Cradle System

One of the most challenging aspects of manufacturing Boeing products is the integration of large-scale structures. In addition to the sheer size, airframes have specification tolerances that are stricter than smaller structures. One specific example of this is the fuselage joining process. Not only must the segments be aligned, the gravity-induced deformations must be accounted for. Recently, Boeing has been developing the active cradle system to take on these challenges. In this paper, we describe the mathematical model used to predict the behavior of the fuselage sections as they are modified by the cradle.

36 | Surface Smoothing of Powder Bed Fusion Additive Manufactured Ti-6Al-4V Components

Metallic powder bed fusion additive manufacturing (AM) processes for Ti-6Al-4V enable fabrication of complex geometries that are not practical using traditional manufacturing processes. However, the resulting rough surface finish causes design challenges in form, fit and function. It impacts mechanical properties (including fatigue life reduction) and impacts the resolution of non-destructive inspection imaging. While there are a relatively small number of potential part applications that are non-fatigue critical, many more part application opportunities exist for aircraft components with fatigue strength requirements. Conventional machining of rough surfaces is effective, however costly when applied to complex geometries. This paper describes ongoing efforts to identify alternative approaches for surface smoothing of the powder bed fusion AM surfaces, including description of challenges and technology gaps and results from surface smoothing technology evaluations.



Building the future

When I walk through a Boeing factory and see how new technology is transforming the workplace, I am amazed and grateful for all the people who are bringing innovation to the production system.

The factory is where ideas are brought to life in the manufacturing process. Whether we're building a helicopter, fighter jet, commercial airplane or any other product, people connect the production system.

Lean thinking and technology drive how we manufacture and build our products to continuously improve safety, quality and flow. Technology to me is the heart of innovation, but our amazing teams also innovate processes and new services. Innovation is in everything we do.

Today, mechanics are learning to use exoskeletons and virtual reality headsets to assemble parts of the airplane and train for complicated procedures, like landing gear installation, improving quality and safety. In 2018, we identified over 500,000 parts as potential candidates for 3D printing, and we're even bringing to reality 3D printing of satellites. Digital technology is informing the factory with new apps and real-time data.

The pace of innovation sweeping through Boeing and the aerospace industry is accelerating and reaching every aspect of our business. We are partnering with many stakeholders to build a digital thread that would connect our supply chain end to end. With digitization now at our fingertips, our long-standing challenge—to simplify our processes, update our tools and connect the supply chain all the way into our subtier suppliers—is also our opportunity.

I know we can succeed. Like Einstein said, "Logic will get you from A to B; imagination will take you everywhere."

We aspire to exceed our customers' expectations with innovation in all that we do. 

JENETTE RAMOS
Senior Vice President
Manufacturing, Supply Chain & Operations

Recognizing Advanced Developments and Research

Technology RADAR

The confluence of several technologies are unlocking manufacturing and supply chain capabilities for systemic change.

These advances are in the fields of data analytics, artificial intelligence, sensors, extended reality, additive manufacturing and robotics. In parallel, a digital transformation—especially through model-based engineering and predictive simulations—fosters production system fine-tuning before production even begins.

The results go beyond cost and performance benefits. The circular design movement has companies beginning projects with intentional environmental solutions.

Wearables, smart factories and augmented reality are driving better ergonomics, safety and a more effective experience for the people at the heart of a production system. 

People working in Boeing's Technology Intelligence and Trends community of practice are human sensors in the world of science and technology. We make it our business to watch for innovations in practice, new business models and new ways of thinking. Here's a peek at a few signals on the screen.

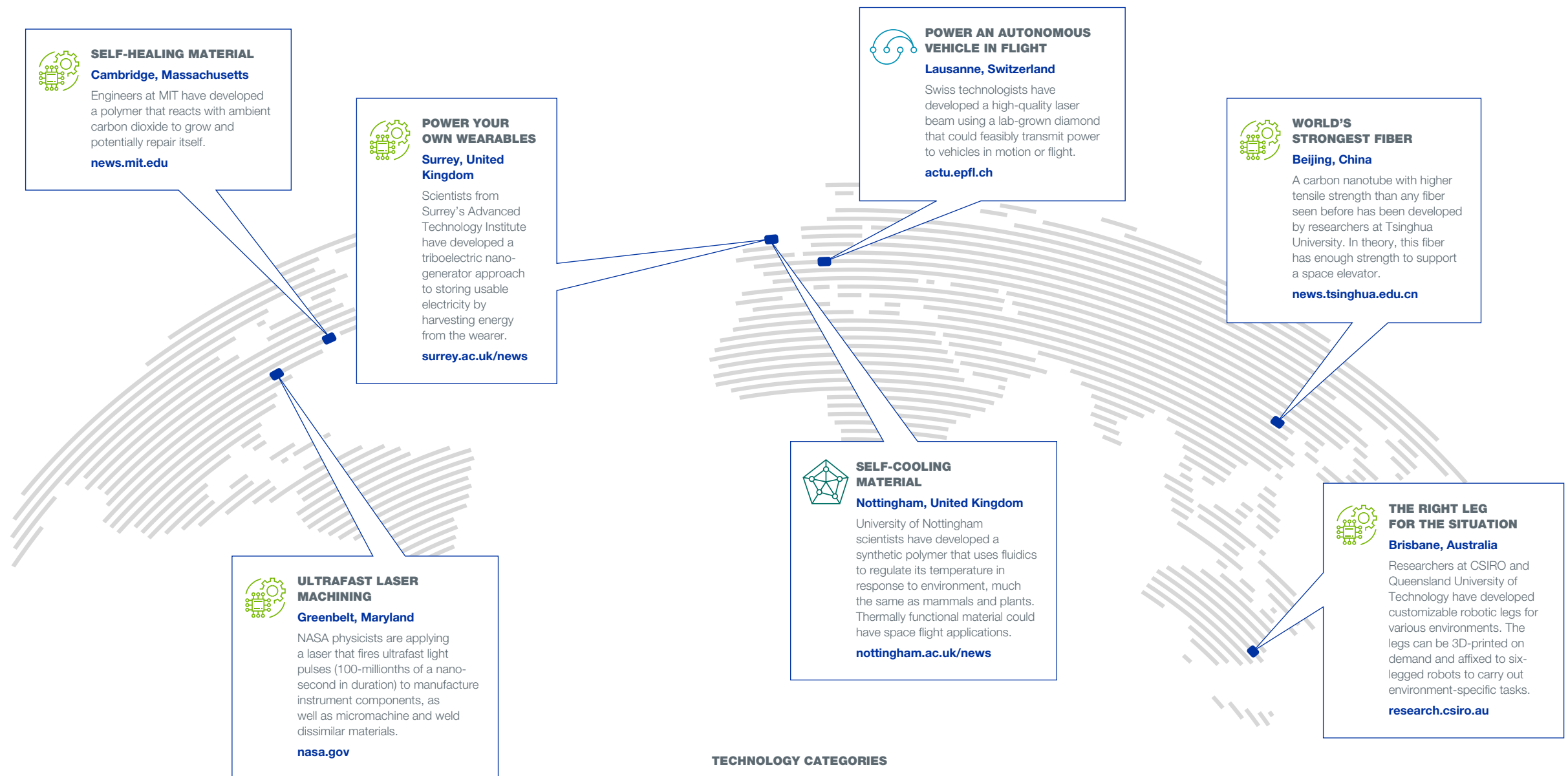

TECHNOLOGY CATEGORIES



Integrated Platform
Performance



Platform Systems
& Subsystems



Materials &
Manufacturing

Going 20 years at 200 miles

The International Space Station's contribution to human knowledge is measured in thousands of experiments, hundreds of spacewalks and a generation of life in space.

BY CARRIE ARNOLD, BOEING WRITER

STILL FLYING HIGH

The International Space Station on Oct. 4, 2018, photographed by Expedition 56 crew members from a Soyuz spacecraft after undocking.

PHOTO: NASA

A unique laboratory orbits overhead as a pinnacle of human achievement. It makes fresh contributions every day to improve life on Earth and pave the way to success in future space exploration.

The achievements of the International Space Station (ISS) began over 20 years ago with the launch of a modest module from Russia and a connecting node from the United States.

For Boeing, the journey had started years earlier with the first space station designs. Changes cycled through the system and ultimately a new international partnership with Russia cleared the way for humanity's most complex manufacturing project—a spacecraft assembled in Earth's orbit.

"The International Space Station enables future exploration by validating key technologies, systems and sciences that help us understand how astronauts will live and work through long-duration missions," said Peter McGrath, a director in Boeing's Space Exploration division. "It also serves as proof that Boeing and our partners have the engineering and operational capabilities to assemble a successful, habitable and sustainable structure in space."

On Nov. 20, 1998, the world watched as the Russian-built Zarya module launched into orbit. Two weeks later, NASA's space shuttle Endeavour launched the Boeing-built Unity module. During three spacewalks on the STS-88 mission, the two space modules—engineered on opposite sides of the planet—were joined together in space, marking the beginning of an unprecedented global effort to construct the ISS.

“The groundwork we have laid through collaboration with NASA and our international partners to build and support the station will allow for a robust human presence in space for years to come.”

**MARK MULQUEEN, BOEING'S
MANAGER OF THE INTERNATIONAL
SPACE STATION PROGRAM**

**DESIGNED ON EARTH,
ASSEMBLED IN SPACE**

Boeing engineers working on production of ISS module Unity in 1997.

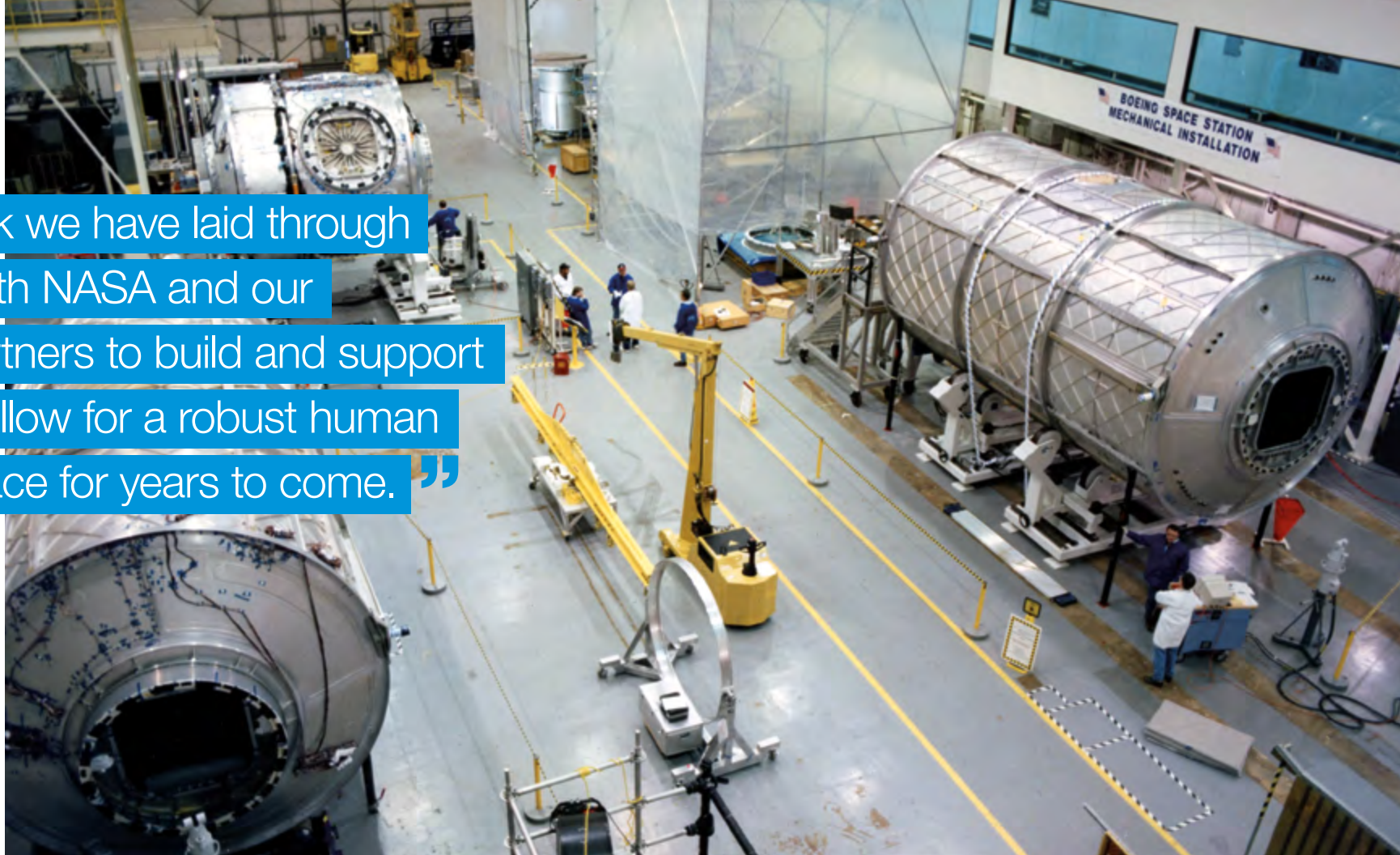

Boeing's accomplishments in low-Earth orbit have continued over the past two decades. In 2018, a team of engineers developed software that doubled the downlink speed of ISS computer systems, allowing more research and data to be transmitted at higher speeds to researchers on the ground.

Recently, Boeing and NASA teams began the process of installing a new set of Boeing-built lithium-ion batteries for the station. Capable of storing more energy than the station's current nickel-hydrogen batteries, these upgraded batteries can also be charged and discharged more rapidly, and aren't as susceptible to the "memory effect" that occurs when a battery is recharged before it is fully empty, diminishing its overall capacity.

Boeing engineers also built and tested the mechanisms that will connect future Commercial Crew spacecraft with the ISS. The first International Docking Adapter (IDA) was delivered to the station and installed during a spacewalk in 2016. The second IDA will be brought to the station on a future cargo resupply mission. When both docking rings are in place, the station will be equipped with physical connecting points for astronauts arriving to the orbital platform aboard America's first human-rated spacecraft since the space shuttle.

Selected by NASA as the prime contractor for the ISS in 1993, Boeing remains responsible for maintaining the station at peak performance levels through a dynamic series of missions: Since 1998, the ISS has hosted 232 individuals from 18 different countries. More than 200 spacewalks have occurred, totaling more than 1,300 hours to build and maintain the station.

Boeing teams support ISS from the ground with operational and technological solutions that continue to advance ISS mission capabilities. The station, now the size of a U.S. football field and weighing almost a million pounds (453,592 kilograms), is an engineering marvel unlike any the world has ever seen.

Traveling at 17,500 mph with an altitude of around 250 miles above Earth, the orbital laboratory hosts a wide spectrum of scientific research leading to profound discoveries in fields as diverse as medicine, agriculture, robotics and astrophysics.

Groundbreaking experiments conducted for programs like Genes in Space and MassChallenge not only benefit life on Earth, but also serve as critical steps in expanding humanity's footprint in deep space. The microgravity environment aboard ISS has been an optimum setting for thousands of studies, including new, more effective cancer treatment options and the development of medicine that has doubled life expectancy for thousands born with Duchenne muscular dystrophy.

"The magnitude of Boeing's accomplishments over the past 20 years reaches far beyond the company," said Mark Mulqueen, who manages the International Space Station program for Boeing.

"ISS remains a beacon of hope for what humans can accomplish when we come together in support of innovation and exploration," Mulqueen added. "The groundwork we have laid through collaboration with NASA and our international partners to build and support the station will allow for a robust human presence in space for years to come." 

PHOTOS: BOEING AND NASA



International Space Station Facts

Pressurized Module Length:

240 feet (73 meters)

Truss Length:

357.5 feet (109 meters)

Solar Array Length:

239.4 feet (73 meters)

Mass:

419,725 kilograms

Habitable Volume:

13,696 cubic feet (388 cubic meters)
Not including visiting vehicles

Pressurized Volume:

32,333 cubic feet (916 cubic meters)

With BEAM Expanded:

32,898 cubic feet (932 cubic meters)

Power Generation:

8 solar arrays provide
75 to 90 kilowatts of power

Lines of Computer Code:

Approximately 2.3 million



MIKE VANDER WEL
CHIEF ENGINEER

Engineering a global industrial champion

The future is indeed bright for industrial engineering roles, including production and systems engineering, human factors and safety engineering, and management science.

When history books are written thousands of years from now, the world will expectedly remember our society for medical advances, miniaturization and the impact of both the internet and aviation to make the world a smaller place.

Within the annals of aerospace history, these particular times will be remembered as a golden era for attacking and solving industrial challenges on a global scale.

Our innovation will ultimately be judged by the efficiency of our products, the breadth of our influence and our footprint on the environment. That is, how ecologically and economically we can manufacture our aircraft will be as important as how many we can put out there.

In only 25 years from now, the future will look as different as it did 25 years ago when I started my working career. In 1993, the transition from paper and drafting tables to the digital world had begun in earnest; huge improvements were expected when computing excellence was measured in kilobytes and megabytes. The production system was developed and optimized with industrial engineering effort that happened on paper and with sheer human effort. It was a time when discrete event simulation and flow modeling were only a dream.

Today, we carry at least one or several versions of a supercomputer around with us and can communicate and execute on ideas as soon as we decide to.

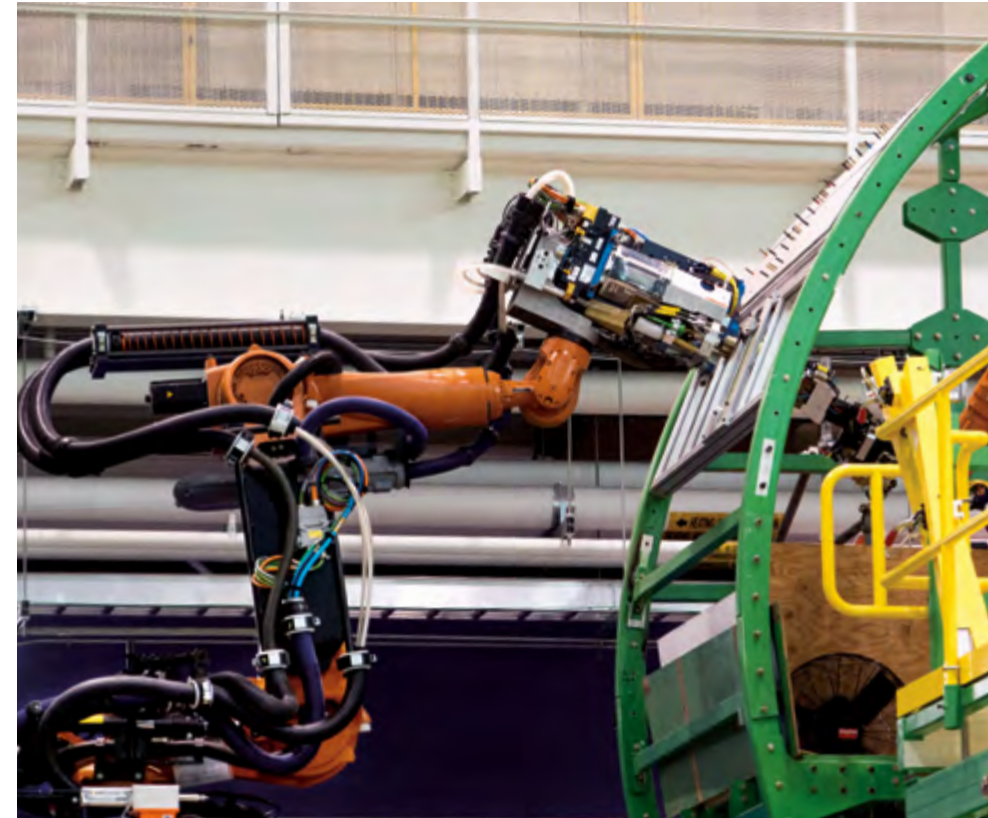

LENDING A HELPING ARM

Automation tools like this robotic arm help improve workplace safety in assembling aircraft and allow technical staff to apply their creativity toward broader goals.

PHOTO: BOEING

stages of a product life cycle what are the right decisions to make. Our factories across the globe will be larger, smarter, more efficient and centered around human achievement.

Along this journey, production engineers at Boeing will do amazing things, making it a magnet for fresh and ambitious talent from around the world. Engineers will have moved us from the static production system capability of today to tomorrow's complex adaptive systems that are resilient to changing conditions.

Of course, to unlock this exciting future it will take the vision and energy of a multitude of talented people from around the world who are not even in the company today; some of the biggest future contributors are not yet born.

The ability of new engineers to build on the shoulders of the previous generation will continue to accelerate. Future engineers will thus achieve great things and in turn have a larger influence on their world. **IQ**

Mike Vander Wel, is chief engineer for commercial production engineering in Boeing Commercial Airplanes.

Looking further into the future, Boeing will be one of a few industrial champions to survive low odds to still exist at 150 years old. We will have figured out how to marshal the efforts of larger teams of people to solve bigger problems, doing so with complex system modeling, artificial intelligence algorithms and big data techniques.

The industry will be much advanced from today—for example, we can expect the large technology gaps in propulsion systems to be filled with efficient and powerful engines, enabling space travel on a large scale. We will be reaping huge automation benefits for completely breaking our 1960s aerospace design paradigms. Automation will have changed how white collar work is performed, freeing engineers' time to creatively attack problems or leverage artificial intelligence algorithms to accelerate change.

The future is indeed bright for industrial engineering roles, including production and systems engineering, human factors and safety engineering, and management science.

How all of these disciplines link together to effectively operate a system that builds real things—really sophisticated things, like airplanes, spacecraft and drones—is significant. There are so many exciting new avenues to solve problems between designing and building both in today's context and where we will be in our bright future.

Machine learning will be ubiquitous and data management will inform increasingly rapid improvements. The data we collect spans the entire electromagnetic spectrum and five human senses, measuring and signaling the right data at the right time. We will have a production system model that can process data instantly and proactively inform leaders at all

Optimum performance

Industrial engineer Lauren Heisey has an interdisciplinary approach to life and to her work.

BY LAURA FENTON, BOEING WRITER | PHOTOGRAPHY BY FRED TROILO

As a child, Lauren Heisey shadowed her grandfather and father at Hess Garage, the family's automotive repair shop in Mechanicsburg, Pennsylvania. As the adults worked on cars, Heisey and her brother, Jordan, sat within earshot, picking up lingo from the shop floor and computer programming from the office.

She and her father still do all the maintenance on her car, and the oil changes she handles solo. They even participated in a tire-changing competition at the Pocono Raceway in 2015 where Lauren swept the competition and took home first prize in the women's category.

"My dad has a mechanical mindset, which then translated to both of us" Heisey said, referring to her younger brother who is a mechanical engineer living in Austin, Texas. "We shadowed [Dad] on car and house projects because we weren't allowed to stay inside and watch TV all day."

Now seven years into her Boeing career, Heisey works with cargo helicopters outside Philadelphia. As an industrial engineer, Heisey works with production and the manufacturing of the Chinook.

She finds ways the team can improve processes for a safer workplace and become more cost-effective. Heisey enjoys her broad role because she interacts with all facets of engineering at the facility, helping other engineers prioritize the production when things need to be built outside the traditional order, for example. Her work is partly in the

building's office area, but mostly Heisey spends time on the production floor where she can see if the current process is working and how to make things more efficient.

Previously, Heisey also worked on a project to improve the processes for salvaging parts from used transmissions. The new process required a redesign of the facility, replacing work tables with conveyor belts containing only one part at a time so employees could review parts faster.

"She's always been very data oriented and very good in Excel, as well as streamlining repetitive processes that a lot of industrial engineers do manually," said Timothy Lunger, a senior manager in production engineering, and one of Heisey's mentors. "I think Lauren really exemplifies someone dedicated to whatever it takes to support us in production engineering."

Heisey's parents intentionally brought their children to work and even financial meetings so they would have a broad knowledge base. In addition to the shop, Debbie Heisey, a nurse, took her children to the hospital on designated days.



"I think Lauren really exemplifies someone dedicated to whatever it takes to support us in production engineering."

**TIMOTHY LUNGER,
A SENIOR MANAGER IN
PRODUCTION ENGINEERING**

The Heiseys recalled one afternoon when they gave Lauren, who was in elementary school, spare wood pieces, a box of nails and a personalized hammer. They told her to go and play. When Lauren returned, she presented her father a message nailed into the wood: "I love Dad" with a heart symbol for the word "love." It's still displayed in their house along with other items Heisey has crafted, such as a wine rack she made from scrap wood.

"She's always been a driven child, and she's very caring, and willing to learn," said Debbie Heisey.

From seventh grade through her senior year of high school, Heisey participated in her local chapter of the Technology Student Association, which engages students in science, technology, engineering and mathematics competitions and leadership opportunities. One year Heisey entered the flight challenge category, where students transformed a piece of balsa wood into a small airplane that could fly

and land safely. Heisey made it to the state competition with her airplane model. Although she entered categories like nanotechnology or biotechnology, the flight challenge was her favorite.

It wasn't until high school that Heisey officially chose engineering for her career path. Her physics teacher, David Shoemaker, encouraged Heisey to take a look at engineering since she grew up in a family of mechanics. It was at that moment, while standing in the halls of Mechanicsburg Area High School, Heisey decided to go for it.

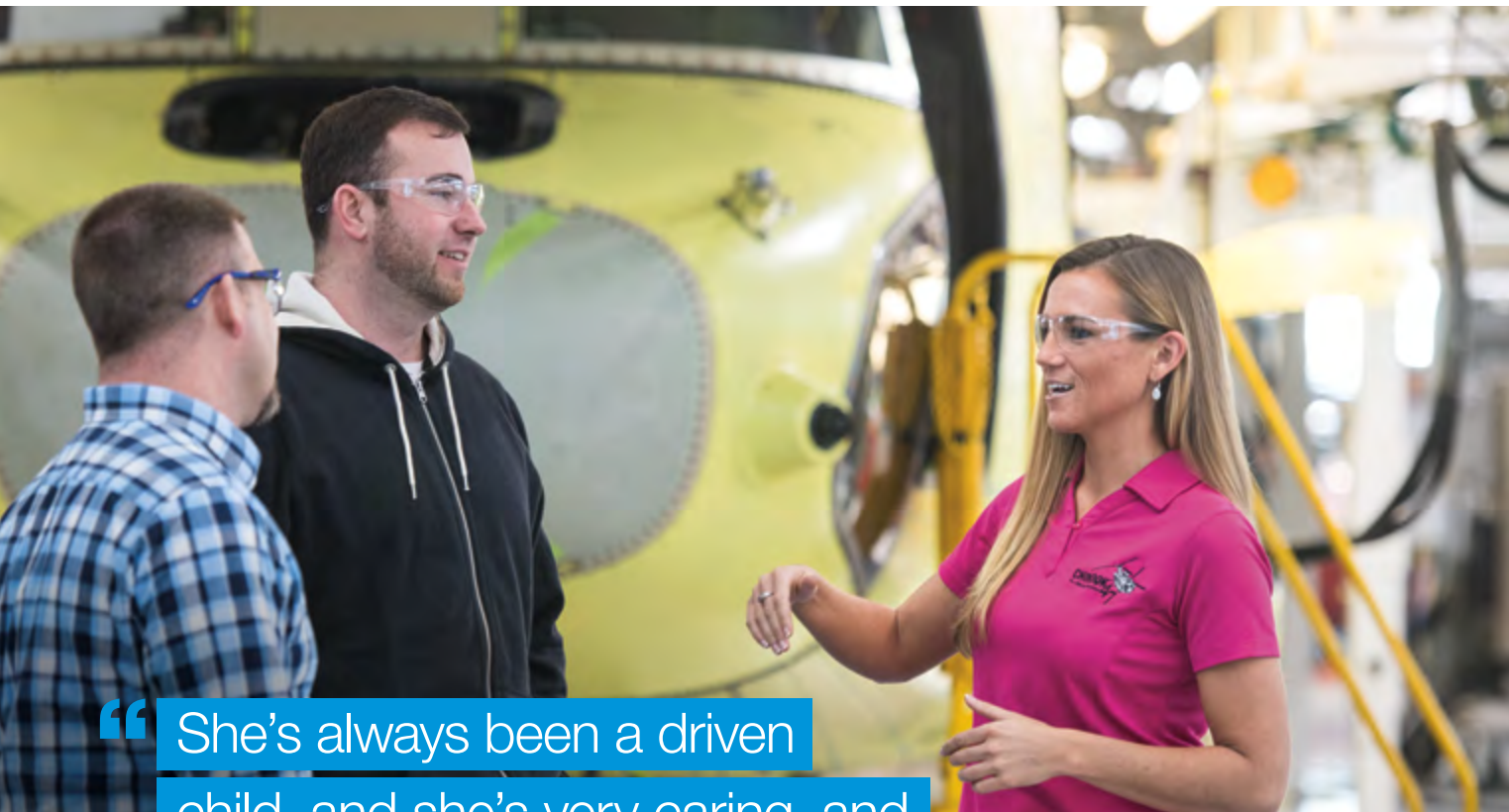

“She’s always been a driven child, and she’s very caring, and willing to learn.”

**DEBBIE HEISEY,
LAUREN'S MOM**

INDUSTRY FOCUSED

Lauren Heisey discusses process improvements for the Ridley Park, Pennsylvania, facility with teammates Bill Law (left) and Chris Sutton (right).

The decision led her to Boeing as an industrial engineer, and she is forever grateful to Shoemaker. "I never actually told him that," Heisey said.

Shoemaker recalls Heisey was a quiet student.

"I remember her as being typical because the high school physics class was not easy for her," he said.

"She worked, she studied, and she came in and asked questions. She did not do great on every test. There were struggles, but yet, she took those struggles and worked with them. What I've seen in my classroom currently, and have for years, is my class is rigorous. In some cases this is the first class [students] struggle with," he explained. "That's normal. That's how science works. It's not easy."

Shoemaker often finds himself reminding students that having to study and work for good grades in science doesn't mean you should shy away from it.

More people will need to enter the engineering field in the next five years to keep up with the anticipated 4 percent job growth, according to the U.S. Bureau of Labor Statistics. Industrial engineering employment is projected to increase 10 percent from 2016 to 2026.

In addition to her work as an industrial engineer, Heisey also served as president of the Boeing Women in Leadership (BWIL) Philadelphia chapter for the past two years. Both years of her time as president, the chapter earned the Business Resource Group Impact Award, as well as increased membership by 35 percent.

"Lauren has tremendous potential and almost unbridled energy that makes me feel really good about the future of our company," said Randy Rotte, executive sponsor of BWIL and a director in vertical lift programs at Boeing. "Being closer to the end of my career than the beginning, one of the more important roles I see is trying to prepare and foster that next generation of leaders for the company, and Lauren is certainly one of those."

As a versatile discipline that covers broad fields of manufacturing, supply chain management, process flow and control, and systems engineering, industrial engineering seemed to be a natural calling for someone of Heisey's wide-ranging interests and technical capability.

Heisey has also set her sights on the sky, pursuing a pilot's license for fixed-wing aircraft, which she intends to complete in early 2019. It wasn't until Heisey learned multiple co-workers were also working on pilot licenses that she considered it. Adding pilot to her resume was on par with Heisey's other hobbies of scuba diving, sky diving, skiing, riding motorcycles and working on cars. (Her mother refers to Heisey as a daredevil.) Rotte, who also flew helicopters for 26 years with the Army, enjoys hearing Heisey's updates.

Bob Buccino, certified flight instructor with FlightSafety International where Heisey is a student, also worked as a chemical engineer and enjoys when he and Heisey get to "talk shop" about engineering.

Although Heisey's goal is to earn her pilot's license, she's also looking forward to another milestone. "I always wanted to go into aviation because my dad likes it," she said. "I know it sounds cheesy, but I want to take my dad up for a ride once I'm certified." 



TAKING THE JUMP

Heisey gives sky diving a chance in 2016 over Dubai, United Arab Emirates.

Distilling solutions

At Boeing's factory moonshine shops, innovators make something from nothing.

BY DAN CAHILL, BOEING WRITER

With the parts to his parent's VCR strewn across a table, young Tim Pope had a clear picture of what he wanted to do in life.

"If anything had screws in it, I was taking them out," said Pope, a "moonshine" mechanic in Frederickson, Washington.

Not much has changed for Pope since his curiosity-seeking childhood.

"To this day, I'm that way," he said. "If my wife's phone doesn't work, I take it apart and try to fix it. In my home, I do everything. My attitude has always been, if somebody can work on it, then I can."

Pope takes that same attitude to work every day where he helps support the fabrication and assembly mechanics working on the 777, 777X and 787 programs.

It's a pattern in Boeing factories.

Although they're known as the Moonshine Team, operations manager Bob Brady and his highly skilled crew in Everett, Washington, would prefer to be called the "Sunshine Team."

With origins in Japanese manufacturing, these moonshiners are mechanics tasked with identifying production issues and quickly creating solutions. They often work nights, ostensibly by the light of the moon, thus their name.

"We don't do things under the cover of darkness," Brady said of his small shop that fabricated a big fix on a tool used for installing the 787 landing gear. "We embrace everybody so the customer gets what they want."

For example, Brady's moonshine shop was asked to come up with a solution for a "gagging" tool used to compress

the 787 landing gear for installation. Previously, mechanics balanced on a 4-inch beam about 4 feet off the ground while manipulating a 35-pound tool to perform this task.

After a safety request was written on the tool, the moonshine shop went to work, devising within days a broader platform using 50 percent recycled materials. Not only did the team provide a safer environment for mechanics, but it saved the company hundreds of thousands of dollars it would have cost had the vendor gotten involved with the issue.

"Engineering was quite impressed with our fix, and they joined us to help," Brady said. "Between moonshine and tooling (employees), we came up with a solution within a week and had something to work with."

The gagging tool is just one of several fixes Brady and his team—Jason Hennerberg, Danny Boglivi, Auwyn Hockett, Dan Pilgrim and Keith Gepner—have created over the years.

In 2017, the inventive crew came up with a loading cart that eliminated heavy lifting for 787 workers and saved the company about \$1.2 million over three years.

"We create interim tools quick and effectively to keep workers from getting hurt," Brady said. "We like to say we work by the clock, not the calendar."

Boeing adopted the moonshine method in 1995 as part of implementing a Japanese kaizen philosophy, which means "efficiency" or "continuous improvement." Lean activities, for example, are a large part of this philosophy in the manufacturing sector. Since then, Boeing has hosted a variety of challenges and events, including "Moonshine Wars" competitions. Boeing has also patented several innovations originating in the moonshine shops.

Moonshine is about creating something of value from items already on hand, according to consultants from Shingijutsu in Japan, who teach the moonshine method.

Back in Frederickson, Pope and fellow moonshine teammates Anthony Lenting and Wayne Howard are

"We literally have drawers in our shop that say 'opportunity' on them, because it's random stuff that someday is going to end up being the perfect solution for something."

**TIM POPE,
MOONSHINE MECHANIC,
FREDERICKSON, WASHINGTON**

tasked with getting parts efficiently to the mechanics in ergonomic ways.

Whether it's putting wheels on the side of a three-step ladder for easier mobility or fashioning a resin stir-stick out of a tongue depressor, they're up to the challenge.

Their shop recently devised better cure boxes, a way for mechanics to cure the composites used on the empennage.

The oven previously used to cure the tail section of the plane had to be lifted with a crane and was difficult to maneuver into place.

The moonshiners built new cure boxes that were on wheels, more compact and designed specifically for the part. The quick fix cut 30 minutes off the setup time.

"This particular part was a bar on the tail section of the airplane," Pope said. "It's used to build the wing boxes for the tail section—the vertical stabilizer.

"For composite parts, because they are not always uniform, we use a moldable plastic shim material. It's resin-based material that we have to put between the composite part and the titanium pivot-fitting. They have to give this part a flush-mounting surface. So we use this moldable plastic shim material. That is the material we're curing in place."

Moonshiners enlist a "try storm" method, where they build a concept and tweak the parts that don't work until they do. Because of deadline constraints, it's much harder for engineers to apply a similar approach.

Before the cure box solution, mechanics were using an awkward \$60,000 device that included fans, heaters and various other components. The new self-contained cure boxes encapsulate the heat to cure materials on a part and cost under \$10,000.

The moonshiners called upon their own experiences to deliver a better method.

"As mechanics, we are on the floor and understand how things work," Pope said. "So we were able to put together this much simpler unit, using technology that we know because we use it in our other areas. We were able to use existing things in the shop, like the shop air, to power the fan in conjunction with the process heaters. Using the shop air, it's basically a free resource for us to push that heat through a manifold to heat up the chamber. Because we had floor knowledge in the shop, we could see it clearer than the engineers who are up in a room asked to build an oven."

The serendipity of working in the moonshine shop makes work enjoyable for Pope.

"They come to us for everything and anything," he said. "We continuously make something out of nothing. We literally have drawers in our shop that say 'opportunity' on them, because it's random stuff that someday is going to end up being the perfect solution for something." **IQ**

MOONSHINERS

Wayne Howard (left), Tim Pope (center) and Anthony Lenting never know what opportunity they'll find hiding inside a drawer in their shop.

PHOTO: BOEING



Phil Crothers

marshals Boeing toward the next industrial revolution.



Boeing is actively investing in technologies to enhance the quality, safety and efficiency of the production system—including the supply chain—through the entire product life cycle.

BY CANDACE BARRON | PHOTOGRAPHY BY BARBARA FREEMAN

Q&A with the Technical Fellow who leads Boeing's research investment strategy for materials and manufacturing technology.

Q **How is Boeing preparing to lead in the future of aerospace manufacturing?**

A As an enterprise, we are investing in technologies for productivity, safety and quality, and creating what we call the One Boeing Production System. We are developing composites technology, such as thermoplastics and high-rate processing, as well as metals machining. We are continuing extensive investment in automation to get people out of dirty, dull and dangerous activity, like drilling and fastening. We are also extending human performance with virtual and augmented reality (VR/AR), as well as human collaboration technologies like cobotics and exoskeletons. Automated finishing and coating removal are also highlights in development. Our efficiency in implementing all of these technologies will be a key.

Digital technologies are forming a large proportion of our efforts in additive manufacturing, process control and machine learning. Along this line, it is our internal use of model-based engineering, Industry 4.0 technologies, and revolutionizing our supply chain, which will really see us lead the competition.

Q **What does Industry 4.0 mean to Boeing, and what steps are being taken to prepare the business to lead in the future of manufacturing?**

A Industry 4.0 has had many names, depending on which region of the world you are in. In some cases, it has had the stigma of being this all-encompassing trend that will deliver miracles. So we're paying close attention to where the real value is.

ROBOTS AT WORK

Boeing technologists work to integrate new automation tools into the production systems.

PHOTO: BOEING



At Boeing, Industry 4.0, also called the Fourth Industrial Revolution, will enable the convergence of physical and digital systems. This will cause massive transformations in the way we design, manufacture and service our products, and the ways our customers operate them. It's bringing together traditional manufacturing and design tools such as computer-assisted design and building information modeling, data management and physics-based simulations, and connecting physical assets through the Internet of Things to enable product life-cycle management.

In manufacturing, we are piloting several projects to help us find the key areas of value. These are the digital and systems architectures that will help us be successful locally, and then able to scale quickly. For example, with computing power and artificial intelligence technologies, such as machine learning, we can extract valuable patterns from complex combinations of the many influences on the quality or productivity of our manufacturing processes. These are patterns that would not be exposed by manual methods. By capturing these patterns or machine-learning models and implementing a closed loop of control, we can enhance our operations in real time, while also capturing data that can be run in future design loops. In another example, Industry 4.0 also transfers directly to our management of the supply chain, enabling real-time connection across the globe for reporting, collaboration, control and recovery from disruption.

Q What are the risks and rewards of being an early adopter of Industry 4.0 technologies?

A There are many risks, but the benefits are potentially huge. Behind the risks are questions like, how much will it cost us to extract and exploit necessary data? How long will it be before we see the required benefit from new methods, or will it be more efficient to use contemporary methods of control and process management? What are the right things to control with these technologies? How do we know if we are actually capturing the critical parameters for control of processes?

And then there is the need to choose the right data to use, source and/or store; what are the formats of data we need; can we reuse one method for a second application or do we have to reinvent for each implementation?

But if we can successfully answer these questions, the benefits of delivering and analyzing the right data means we can immediately multiply the skills of our workers; vastly improve our equipment and process productivity and quality; and potentially know of, predict and correct our supply chain disruptions in real time.

Other industries have been investing and leading the way with remote command centers of global production systems and supply chain. We are actively collaborating with other companies to share learning in this new field.

Q How can companies protect their intellectual property or competitively sensitive data with a digital thread that extends to both suppliers and customers?

A People need to trust Boeing. And thanks to our experienced information technology teammates, they can. It is more than a brand; our investments in cybersecurity reflect that. Some of the everyday controls protecting data include access controls, encrypting data, end-point protections and incident response. I'm always staggered to hear the number of emails coming into Boeing that are categorized as spam or malicious that are blocked.

Cybersecurity is one of the major investments that must be made as a part of any contemporary technology development involving digital data. A prime example is the protection of build files for 3D printing in remote machines at customer or supplier facilities. There is potential for IP escapes, counterfeit parts, build package corruption and printing beyond the authorized number of parts. Many developments, including blockchain, secure digital rights management, data delivery streaming and decryption at the machine, are being developed. This will make certain the parameters of operations and vital design intellectual property are contained in approved or certified channels, not reused or corrupted, and that only the designated machine is used for production.

Q What standards need to be established so that Industry 4.0 technologies can be broadly replicated, and who is working to establish them?

A The fundamental purpose of Industry 4.0 is to facilitate cooperation and collaboration between technical objects, which will require an unprecedented degree of system integration across domain borders, hierarchy borders and life-cycle phases. An Australian government report recently cited 22 relevant standards committees within the International Organization for Standardization (ISO) alone, including Information technology, software and systems engineering, safety, Industrial data, robotics, and security and resilience groups.

Within Boeing, we have many groups working in data standards, including making proactive decisions on adopting existing standards, developing our own internal standards, monitoring

external standards development and participating in external developments. Boeing, as a part of the global community, is working closely to try to smooth this path.

Q What methods can the business use to improve the implementation of technologies?

A The continued uptake and refinement of readiness levels, such as MRLs (Manufacturing Readiness Levels) are key, with their greater emphasis on early alignment and integration significantly lowering the risk of transition to the customer's engineering, production system and business operations.

The company is also continuing to improve methods of production hardening. We have different constraints to other industries; because of the high value of our products, physical demonstration is prohibitively expensive. So, unlike automotive, for example, we can't afford to physically prototype hundreds of parts before entering production to prove our new technology inclusions. Once again, digital advancements are key. Simulation tools and digital twins are becoming more and more powerful to minimize the gap between our physical world and our model-based engineering. Developing tools that combine our physics-based models and machine-learning models, based in production data, can be used to directly analyze our engineering models. This allows us to minimize our risks at the design stage. Through these methods we can ensure technology will work in operation the first time. **IQ**



An electroactive collaboration

Boeing and Australian partners are shaping the path for commercially produced inherently conductive polymers.

BY PAT KINLEN, RESEARCH CHEMIST
BOEING RESEARCH & TECHNOLOGY

Electroactive polymers (EAPs) and inherently conductive polymers (ICPs) have been the subject of a great deal of research since the discovery and initial development of ICPs more than three decades ago.

Because electrostatic discharge and electromagnetic interference are major applications of electroactive polymers, these technologies are of high importance to aerospace. Electroactive polymers are used today in applications like sensors and actuators for electronic appliances.

But other applications of electroactive polymers could include actuators and batteries, in addition to sensors and capacitors. The increasing need for electromagnetic interference shielding, for example, will likely increase the demand for this technology. And the electroactive polymer market is expected to exceed more than \$6 billion by 2023, according to an August 2018 report by the global consulting firm Market Research Engine.

Future aerospace systems that are enabled by electrically conductive polymers could feature functionality including energy storage (supercapacitors), electrochromic and charge dissipative optical coatings (for windows, visors and canopies), structural health sensors, and reconfigurable antennas and radomes.

Inherently conductive polymers exhibit a wide range of electrical conductivity—as well as a range of ambient stability in exposure to air and water—that apply to a number of aerospace applications. Though early ICPs were found to be non-processable, recent advancements have yielded highly soluble and processable materials that are easily fabricated into films, coatings and structures.

The proper combination of chemical composition of the polymer can produce materials with especially high conductivity and stability that are on the edge of truly metallic behavior. Conjugated polymers also are between reduction and oxidation charge states, allowing them to be electrochemically switched between charge states.

Boeing research efforts have focused on the synthesis of a solvent soluble polyaniline, PANI DNNSA—an environmentally stable ICP that is readily formulated into electrically conductive coatings. Such solvent soluble ICPs are not available commercially. The synthetic process to produce PANI DNNSA utilized the emulsion polymerization of aniline in the presence of the dopant, DNNSA, and the oxidant. The reaction is highly exothermic and requires precise temperature control at 0 degrees Celsius to prevent the formation of byproducts.

On a laboratory scale, utilizing a batch process, controlling processing is not an issue due to the small volumes involved, usually about 1 to 2 liters. However, to scale processing, temperature control is an issue because generation of higher temperatures may be unsafe in addition to yielding poor quality product. With these issues in mind, a continuous flow process for polymer production that would allow for very efficient temperature control of the reaction process was necessary.

ELECTROACTIVE
Chemist Pat Kinlen

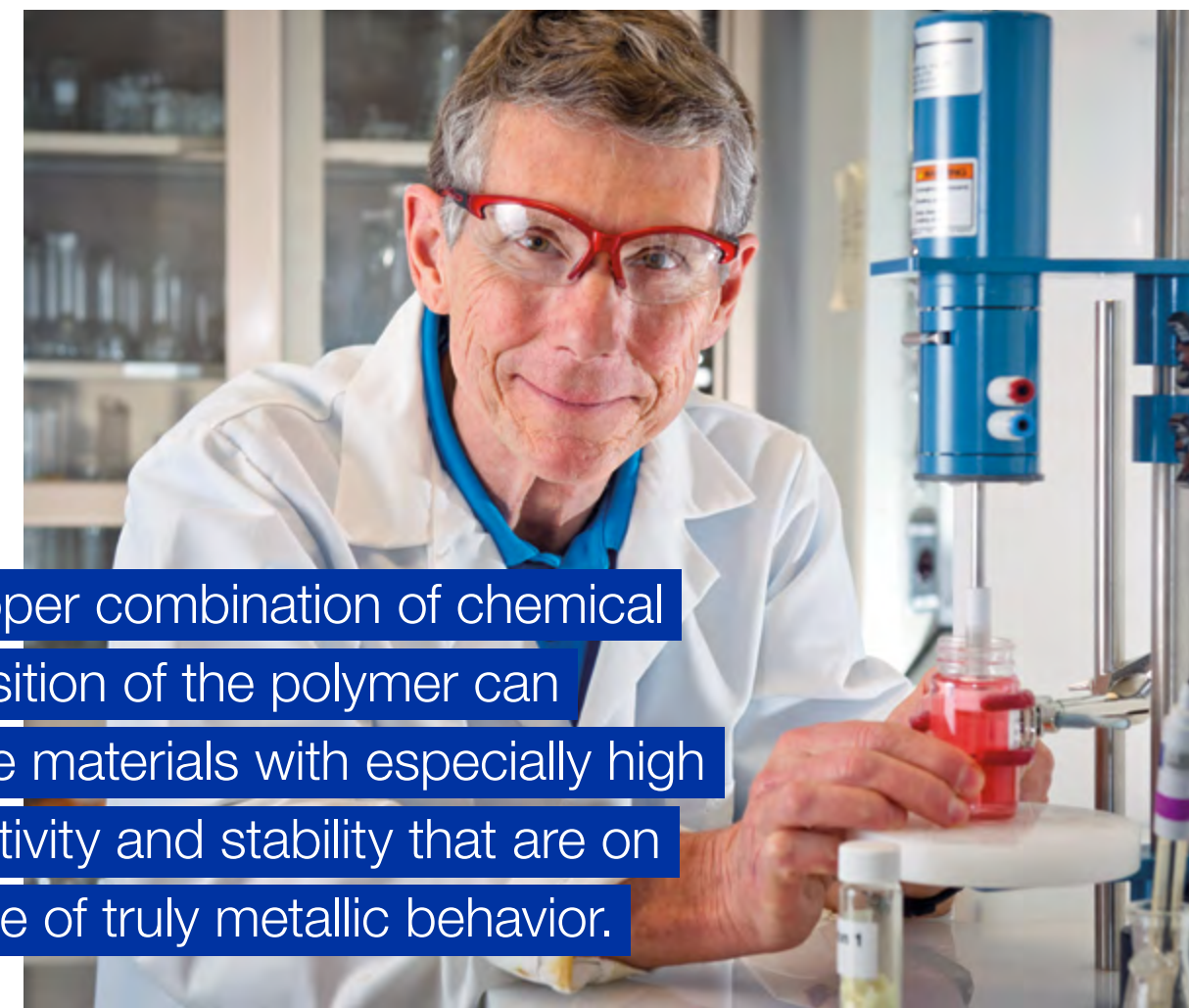

PHOTO: BOEING, MARIAN LOCKHART

As part of the effort, Boeing collaborated with the Commonwealth Scientific and Industrial Research Organisation (CSIRO), a partner in Australia with world-leading expertise in continuous flow processing technology and chemical synthesis. This technology partnership spans more than 29 years, over which time Boeing and CSIRO have invested more than \$140 million toward cooperative research. CSIRO's capabilities span materials discovery, characterization and optimization of chemical synthesis, pilot scale, and technology transfer to manufacturing.

With backing from Boeing's Office of Australian Industry Capability, which supports the Australian government's global supply chain program, Boeing and CSIRO researchers developed a continuous emulsion polymerization process for the synthesis of toluene-soluble polyaniline DNNSA.

The purpose in pursuing a continuous flow process was to:

1. Improve product consistency (run-to-run variation) through precise control of operating conditions.
2. Ensure safety—no need for large volume reactors and handling of intermediates.
3. Enhance product quality through precise temperature control (no exotherm as in batch processes).
4. Increase through-put greater than 50 grams per hour on demand synthesis.
5. Lower capital and operating costs (small footprint) with turn-key operation.

In order to rapidly commercialize this polyaniline product, the flow process co-developed by Boeing and CSIRO researchers was transferred to Boron Molecular, a specialty chemical company in Melbourne, Australia, for production and supply to Boeing. Under the agreement, Boron Molecular will be able to market the product globally. The agreement will simplify the commercialization process and allow the two organizations to more rapidly bring products to market.

GRAPHIC: BOEING

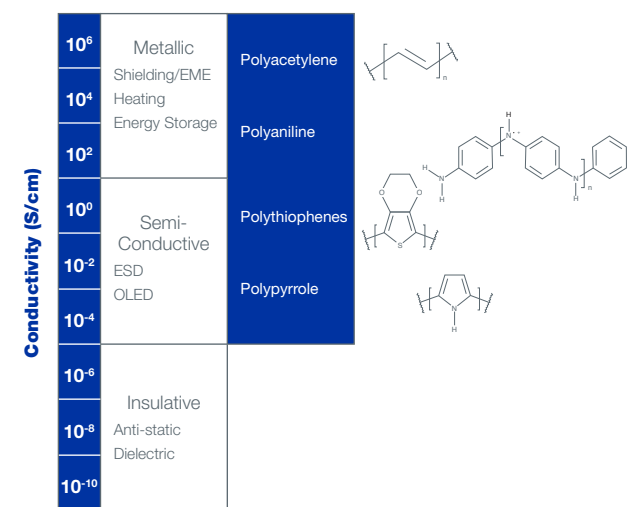

WHERE IT FITS
Conductivity versus applications waterfall

The materials of the future

Two focused applications have been driving ICP near-term development and are now possible due to the continuous flow process and enabling processing at commercial scale: electrostatically dissipative coatings for satellites systems and conductive coatings for rotor blade de-icing.

Controlled-Resistance Conformal Coatings

A new formulation for controlled-resistance conformal coating (CRCC) used on Boeing satellites was formulated using PANI DNNSA. The CRCC is used as a static dissipative coating on printed wiring board assemblies to prevent electrostatic discharge. This new formulation of the polymer could provide more than just a material replacement but may also expand material capability. The increased solubility of PANI DNNSA allows for less solvent to be used, thus allowing for greater viscosity control. Also, the pursuit of a frozen pre-mix will be an advantage simplifying the shipside use of this material. Both of these improvements will widen the possible uses of the CRCC and greatly reduce production times by reducing the number of steps involved in the preparation of satellites for our customers.

Rotorcraft Electrical De-icing Coating

A challenge for rotor blades is the compatibility of an effective and reliable de-icing system that can be coupled with modern, leading edge erosion protection. This is especially the case for incorporation of polymer erosion coatings that are thermal insulators, and for de-icing systems that depend on the use of durable erosion impact protection for longevity from aggressive environments.

An alternative method to conventional rotor blade de-icing is sought using these electrically conductive polymer coatings to maximize de-icing performance and reliability, while minimizing the cost and maintenance associated with conventional electrothermal systems.

Primary benefits of this solution include increased blade coverage, reduced power consumption, vastly improved reparability, reduced impact on blade manufacturing processes and improved system life. In addition, since conductive polymers may be printed and patterned onto surfaces using direct write or ink-jet, electrical circuits may be designed to apply controlled heating to specific areas known to form ice, enhancing de-icing efficiency and effectiveness. **IQ**

Patent spotlight

Check out a few of Boeing's latest ideas and technical breakthroughs recently granted by the U.S. Patent and Trademark Office.

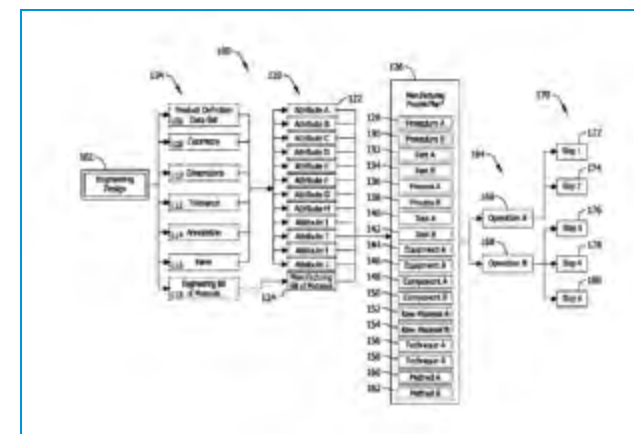

System and methods for managing changes to a product in a manufacturing environment including an anytime design check

U.S. PATENT: 10,162,342
INVENTORS: EDWARD A. DIPIPPO, KYLE KURTIS HAGBERG, CHRISTOPHER LUIS CARPENTER, MAX NEAL JENSEN, ANTHONY JOHN WILLIAMS

When products become larger and more complicated, it becomes considerably more difficult to track all of the parts and processes required to manufacture them. In a global organization comprising technologists from all walks of engineering, seamless and real-time collaboration among these groups is crucial to ensure that products are properly assembled. Communication is critical and accountability is key.

This recently granted Boeing patent describes how to manage engineering and manufacturing changes to a product, specifically changes to a product before, during and after the product is in production. The system is composed of a manufacturing process management computer device that is configured to manage engineering requirements based on completed operations, pre-generate and then manage a manufacturing bill of materials.

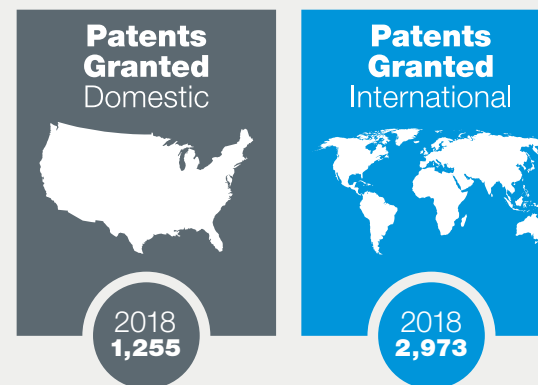

2018 Boeing patents

With a healthy patent portfolio in the United States and internationally, Boeing has continually been acknowledged as an innovation leader by multiple third-party analysts.

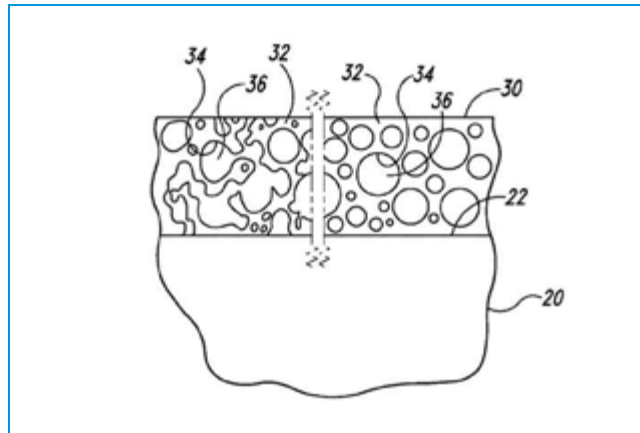

Systems and methods for ignition source testing with flammable foam

U.S. PATENT: 10,132,722
INVENTORS: EDDIE KWON, JASON S. DAMAZO

Many vehicles, including aircraft, typically operate in extreme environments. Because of this, ignition hazard avoidance is a vital element in aircraft design and testing, typically involving reducing the likelihood of ignition, containing the ignition hazard, or withstanding the ignition hazard.

Ignition hazard testing is vital. But it could also involve an explosion, and is time-consuming, cumbersome and expensive. Test systems often require specialized equipment and facilities that consume resources in design, construction, troubleshooting and disposal.

This recently-issued Boeing patent describes a method for ignition source testing using a foam that contains flammable components to indicate the presence of an ignition source on the item to be tested. The foam is applied to the item, and an energy discharge is then applied to the foam-covered test article to create an ignition source. Testing determines whether the flammable components within the foam ignited in response to the energy discharge.

Using a foam with flammable components can eliminate the need for specialized containment vessels, which would make testing easier, quicker and cheaper. Using foam also allows the testers to limit the volume of flammable material to a thin shell surrounding the test article, thus potentially making the tests safer and requiring fewer restrictions on the test facility.

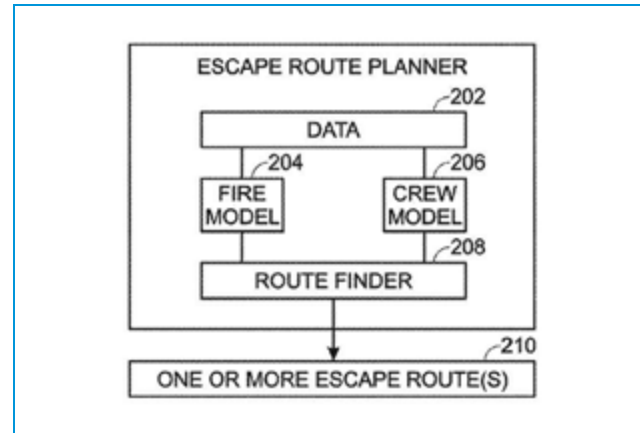

Systems and methods for real-time escape route planning for firefighting and natural disasters

U.S. PATENT: 10,145,699
INVENTORS: CHARLES SPINELLI, ALAN EUGENE BRUCE, DANIEL DALE FULLER, MICHAEL SAHAG

As they battle to contain and extinguish the fire, firefighters are often just one educated guess away from being trapped by the fire. Wildland firefighters need to be able to immediately identify multiple escape routes and multiple real-time, safety zones.

The firefighters must predict three things with some degree of accuracy: how fast the fire will travel, in which direction the fire will travel, and how fast the firefighters will travel. Unfortunately, all three of these variables are difficult to estimate. While weather forecasting and GPS technology have improved, crews still have limited access to reliable up-to-date communication. Technology must be developed to reduce subjectivity and improve the decisions in real time.

Boeing recently obtained a patent for dynamically planning escape routes across terrain based on data related to the fire, the crew and the geographical fire area. A routing algorithm embodied in a computer integrates data from geographical databases, current weather forecast information, fire fuel estimates and locations, and real-time location reports of personnel, resources and equipment to identify routes and areas that are known to be safe. A human factors model takes into account the physicality of individual firefighters, their level of exhaustion, and the weight of equipment they are carrying. The output data are overlaid and routes areas are mapped and rated based on suitability and the firefighter's preference. The firefighter sees all of this on a mobile device that includes a display showing the real-time routes and conditions, which then enables the best possible decision.

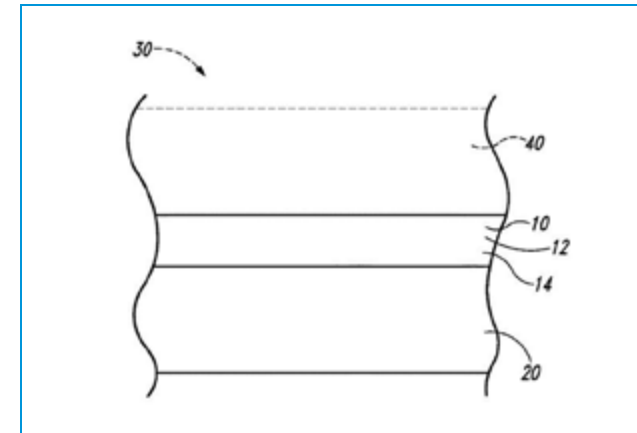

Corrosion-inhibiting sol-gel coating systems and methods

U.S. PATENT: 10,167,394
INVENTORS: PATRICK JOHN KINLEN, LAWRENCE MICHAEL LAWLESS, EILEEN OLGA KUTSCHA

Corrosion damage is a costly problem for environmentally exposed metals. Current conventional surface treatment for metals often uses hexavalent chromium as the active corrosion-inhibiting ingredient. Hexavalent chromium is effective but bad for the environment. However, alternatives to hexavalent chromium are not as effective, have poor compatibility with common coating materials and are expensive.

Sealants generally protect the underlying metal from corrosion. Nonetheless, if the integrity of the sealant's coating is compromised, the underlying metal, which is not visible beneath the sealant, may be compromised. Thus, there is a need for more effective and corrosion-inhibiting coating methods that may enhance sealant performance while being better for the environment.

This Boeing patent granted in January describes a method for inhibiting corrosion by treating metals with the combination of a sol-gel and a disulfide group. Sol-gels, such as Surface Pre-Treatment AC-131, are zirconium-based systems for promoting adhesion of paint to metal surfaces but offer minimal corrosion protection on their own. However, combining sol-gel with a disulfide compound results in a corrosion-inhibiting system that contains no hexavalent chromium. The disulfide compound within the sol-gel protects the metal from corrosion while not endangering the environment. This method offers Boeing (and any future licensees) the opportunity to "go green" without getting rusty.

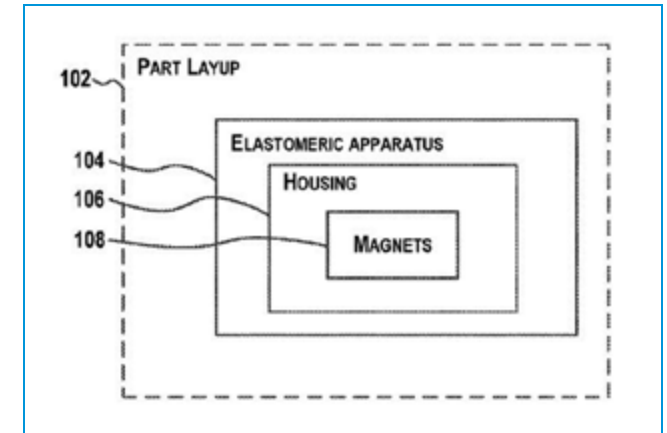

Bladder that changes stiffness based on temperature effects for manufacture of composite components

U.S. PATENT: 10,173,349
INVENTOR: EDWARD HEATH, SAMUEL KNUTSON

Composite parts can be constructed using various curing processes, including the use of a rigid cure tool/mandrel on which the composite material is applied and then cured into a rigid composite part using an autoclave applying heat and pressure to the part during the cure cycle.

Because some composite parts contain internal cavities that collapse under autoclave pressure, placing a bladder or mandrel tool in the cavity is necessary. The problem with many bladders or mandrels, however, is that they are inflexible. A rigid tool is optimal to lay up composite laminate parts at room temperature. However, a flexible tool is optimal during high-temperature curing to conform and evenly distribute pressure across the part.

One of Boeing's first patents issued in 2019 describes a tooling solution that is an elastomer matrix with magnetic components that create a rigid cross-section during automated lamination. When heat and pressure are applied during cure, the magnetic field dissipates due to the Curie temperature effect, and the tool becomes flexible, which allows the cross-section to conform and expand as required.

Welcome to Boeing's factory of the future

Manufacturing revolution comes to the U.K.

BY GARY HILTON AND JAMES NEEDHAM
BOEING SHEFFIELD



GRAPHIC: BOEING

When Boeing officially opened its first European fabrication plant in South Yorkshire last fall, it wasn't just the newest for the company. Boeing Sheffield, with its fully digital-capable infrastructure and state-of-the-art machinery, is a herald for what's to come in manufacturing everywhere.

The site was designed to be the model for Industry 4.0 in the company. The approach was conceived through design-thinking principles aligned to the Boeing production system. The philosophy is concentric around users and how they leverage technology to perform their jobs. This way, the technical design is always focused on enabling the factory and mitigating repetitive motion.

Boeing Sheffield will make more than 100 different high-tech actuation system components for 737 and 767 jets from raw materials sourced in the U.K. These components, used on the trailing edge of both models' wings, are responsible for extending and retracting wing flaps during different phases of flight.

The 6,200-square-meter factory is the newest Boeing Fabrication site. It is also the flagship of vertical integration—the combination in one company of two or more stages of production normally operated by separate companies. The factory is strategically located beside

the U.K.'s Advanced Manufacturing Research Centre (AMRC), founded in 2001 by Boeing and the University of Sheffield.

Boeing's partnership with the AMRC allows the team to accelerate research and development simultaneously with production operations. Boeing has multiple work packages ongoing with the AMRC in multiple value streams, including the digital thread. Before Boeing Sheffield officially opened its doors, the AMRC produced virtual production system models to optimize space, materials and machinery. The models showed the capability for the facility to increase productivity by 50 percent in the future.

The digital thread work package was also specifically designed to de-risk and accelerate Industry 4.0 technologies that will be used in the Boeing Sheffield factory. Adopting the Industry 4.0 framework creates the potential to leverage all of the capabilities of Boeing's 2nd Century Enterprise Systems.

The 2nd Century architecture is a native Internet of Things platform engineered to seamlessly share and communicate data across the production life-cycle management, manufacturing operations management and enterprise resource planning processes.

The models showed the capability for the facility to increase productivity by 50 percent in the future.

THE FUTURE OF BUILD

The Fourth Industrial Revolution, also called Industry 4.0, will be marked by the convergence of digital, biological, and physical or mechanical systems.

Through this new system, Boeing will transform systems and processes across the enterprise to enable better decision-making, improve productivity, reduce cost and generate revenue.

Using 2nd Century Enterprise Systems also sets up an incubator model to displace legacy systems and rapidly move toward this future. This strategy allows Boeing to evaluate these technologies for potential use worldwide across sites that are already operational.

Boeing Sheffield's factory network is the backbone of enabling Industry 4.0 with the ability to interconnect, collect and share data among all computing assets within the factory. A robust yet highly scalable network capable of speeds up to 10 GB per second is coupled by the advanced yet flexible security design of a segmented control point.

This advanced Industry 4.0-ready network is complemented by a stout, powerful and highly versatile converged server chassis; direct attached storage; and network-managed uninterruptible power source equipment. This stack is a fully virtualized, high-availability design with full disaster recovery.

The factory is blanketed with radio frequency identification (RFID) hardware capable of ultra-wideband and passive tracking. This infrastructure is designed to track and trace tooling, parts, components and any other items deemed valuable to the success of the factory. The RFID hardware will be integrated with multiple systems to enable a supply chain digital thread for the factory.



PHOTO: NATO

Global Scale

Upgraded AWACS for NATO

Boeing has delivered the final Airborne Warning and Control System (AWACS) aircraft modernized with avionics and a digital cockpit to the North Atlantic Treaty Organization (NATO) in Manching, Germany. Upgrades include five full-color digital displays in each aircraft that provide crewmembers with customizable engine, navigation and weather data. These digital capabilities ensure NATO AWACS compliance with current and future air traffic control and navigation requirements and also allow NATO to consolidate crew responsibilities. The 14 AWACS aircraft are the alliance's first integrated, multinational flying unit, providing rapid deployment, airborne surveillance, and command and control for NATO operations.

European autonomous systems airspace management

Boeing has joined the EU Network of U-Space Demonstrators, a Europe-wide platform for unmanned aircraft systems airspace management initiatives, including future technology—in particular beyond visual line of sight and automated operations—and the associated regulatory framework. The network aims at creating a safe, reliable and sustainable future mobility airspace for piloted or autonomous vehicles in order to address transportation challenges such as increasing urbanization, a growing global population, aging infrastructure and increasing e-commerce.

Customized services for supply chain and logistics needs

In order to meet airlines' growing supply chain requirements for parts and logistics solutions, Boeing has launched an integrated material solution (IMS) that offers 24/7 parts support at more than 75 parts depots globally. IMS provides demand planning and management of more than 12 million rotatable parts—providing customers with guaranteed parts availability, reduced logistical complexity, cost savings and improved cash flow.

A key component of the supply chain digital thread is Boeing Sheffield's enterprise resource planning system. This system will use location data to manage material procurement through delivery. This data, together with performance data collected from the automation, will feed the site's discrete event simulation model. This tool has the capability to model the factory from goods in to goods out in real time. The technology provides an unprecedented level of transparency into the production system and establishes the factory's digital twin.

Boeing Sheffield will also be the first site to deploy the company's manufacturing execution system apriso. This application is part of a forward-facing architecture designed to "bolt on" the rest of the 2nd Century portfolio as services become available.

The Sheffield site will also use an advanced tooling database management system to track, trace and maintain configuration management of all production cutting tools. These tools will all be RFID-enabled to allow digital tracking and monitoring of performance data, and to establish the engineering digital twin with the tooling model. This will streamline the numerical control programming processes and ensure first-pass quality on cutting-tool delivery. 

Selections from the Boeing Technical Journal

The Boeing Technical Journal is a peer-reviewed periodical for Boeing subject matter experts to capture and share knowledge. Research coverage includes all manner of commercial and defense product development, and products and services spanning land and sea, to air and space, and cyberspace.

Contributing Authors

Model and Analysis of an Active Cradle System



WILLIAM R. FERNG

is a research scientist and applied mathematician in Boeing's advanced research and technology organization.



JEFFREY H. HUNT

is a Boeing Technical Fellow in systems technology, with expertise from condensed matter physics to advanced production systems.

Surface Smoothing of Powder Bed Fusion Additive Manufactured Ti-6Al-4V Components



MATTHEW R. SOJA

is a structural analyst in Boeing's advanced research and technology organization developing and implementing additive-manufactured parts for structural applications.



K. CHANNA R. DE SILVA

is a chemical engineer in Boeing's advanced research and technology organization and an expert in surface treatment and analysis.

The Journal is a proprietary publication, but the articles on the following pages are summaries of technical papers approved for public release and available online at Boeing.com.

Model and Analysis of an Active Cradle System

Summary

BY WILLIAM R. FERNG | JEFFREY H. HUNT

One of the most challenging aspects of manufacturing Boeing products is the integration of large-scale structures. In addition to the sheer size, airframes have specification tolerances that are stricter than smaller structures.

One specific example of this is the fuselage joining process. Not only must the segments be aligned, the gravity-induced deformations must be accounted for.

Because of the massive scale involved, an aircraft fuselage is typically manufactured in sections. The sections are attached later by drilling holes and applying brackets and bolts. Because it is impossible to build the subsections to arbitrary precision, the fuselage sections might not align properly and the attaching of sections must be delayed. There may be extensive additional work to overcome.

One specific example of this is the fuselage joining process. Not only must the segments be aligned, the gravity induced deformations must be accounted for.

To address this challenge, Boeing is working on an active or adaptive cradle. It consists of a frame with actuators positioned only along the lower half of the barrel, and forces can be applied to these actuators so that the barrel can be adequately deformed to match the contour of the adjacent section, allowing the fastening process to take place.

In this paper, we describe the mathematical model used to predict the behavior of the fuselage sections as they are modified by the cradle.

Natural questions regarding such systems include (1) how does it operate and (2) what degree of risk, meaning unexpected damages to the fuselage, does it have?

The basic notion of an active cradle is that a section of the fuselage can sit in a cradle, and forces can be applied

at different locations along the bottom half of the fuselage barrel edge to achieve desired displacements all around the barrel aligning the section for attachment with its adjacent fuselage section.

Mathematical model and algorithms for computing the optimal forces needed to achieve desired displacement were fully described from a prior Boeing technical project. One of the concerns related to such an active control system is whether the process or applied forces can lead to unexpected material damage. The purpose of this paper is to address such concern by establishing a theoretical result that provides conditions under which we can ensure we are safe from causes of unexpected material damage. We further perform statistical analysis of the data obtained from actual experiments and derive statistical inferences.

Given a barrel with initial displacements from nominal shape $b_0 \in \mathbb{R}^m$, the objective of the active cradle system is to compute forces $x \in \mathbb{R}^n$ so that the following condition is satisfied:

$$\|\varphi(x) + b_0\|_\infty \leq \delta,$$

where $\delta > 0$ is the maximum allowable deviation from nominal shape. That is, we seek to find forces x to deform the fuselage shape sufficiently to

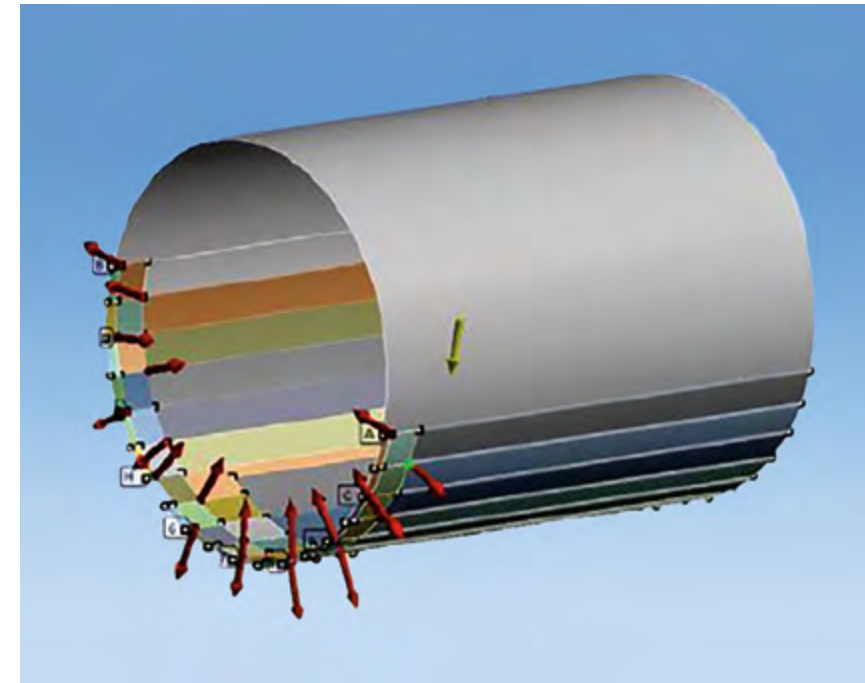

FIGURE 1.

A Model of the fuselage barrel is shown. The deformation forces are represented by arrows. In this particular case, forces are shown that are applied radially to the edge of the barrel. Tangential forces would be applied at the base of those arrows, perpendicular to the radial forces.

counteract the displacement b_0 so that all displacements from nominal are within the maximum allowable deviation.

We model the forces as being normal to the barrel with positive forces pointing toward the interior and negative forces pointing outward. The displacements are measured in normal-tangential coordinates, and we assume that m accounts for this; i.e., there are actually $m/2$ measurement locations, each location with normal and tangential components, so that the resulting vector b is of size m . The system is currently designed to apply only normal forces. Our model and analysis still works when considering tangential forces, but the mathematics become a little more complicated (and the subsequent optimization a little more challenging).

Efficiently solving any of these problems in practice requires a little more reformulation. In practice, the optimization process can be applied iteratively to achieve a desired and optimal solution. An active control system iterates between applying

optimal forces and updating the displacements as the process proceeds. In each iteration, two tasks are based on the behavior of the structure φ , and the optimization process O .

One of the major concerns related to the active control system is whether or not the optimization process and the fixed-point iteration can lead to an unexpected outcome in which the material is damaged. That is, unexpected displacements in the control loop which could damage the material.

The possible causes of material damage include:

- Material strain limit unexpectedly exceeded.
- Inaccuracy in the system matrix approximation leads to unexpected wild behavior.
- Spike in displacement occurs between adjacent measurement locations.

The following mathematical notations are used throughout this summary:

- $x \in \mathbb{R}^n$: A vector of n actuator forces.
- $b \in \mathbb{R}^m$: A vector of m measured displacements from a pre-defined nominal shape.
- $\delta > 0$: The maximum allowable deviation from nominal shape.
- $L > 0$: The maximum allowable actuator forces applied.
- $\varphi : \mathbb{R}^n \rightarrow \mathbb{R}^m$: The physical deformation of the barrel as an unknown function of applied forces.
- $A \in \mathbb{R}^{m \times n}$: The system control matrix used as an approximation of φ .

Material strain is computed at the finite element analysis (FEA) level, and the strain limits are roughly 1.5 percent of the length of the element. Because this is assessed via FEA, strain checks cannot be efficiently performed inside a control loop. If we make the reasonable assumption that corrections to the initial optimal forces inside the control loop are small compared to the initial forces themselves, then the strains measured by the FEA when optimal forces are applied should be sufficient to enforce the safety concern that strain limits never be violated. It is unclear at this point how to incorporate strain limits into the optimization problem. Strain limit violation was never observed in earlier analysis.

The function ϕ is the physical deformation of the fuselage barrel as an unknown function of applied forces and is essentially a black box. The approach taken here is to construct a system matrix as an approximation of ϕ . In practice, the construction of a system control matrix can be accomplished either from a detailed FEA or by actually physically deforming the barrel and taking precise measurements. This is done by choosing a set of suitably defined unit vectors of forces, applying each set of unit forces and measuring the resulting displacements. The resulting measurements become the columns of the system matrix.

Because of how fuselage sections are constructed, we only consider actuator positions that coincide with stringer locations on the bottom half of the barrel so that the structure is not damaged by applied forces. A possible actuator location (stringer) is called a control node. On the other hand, displacements are measured at specific locations around the fuselage barrel called response nodes. Control node and response node

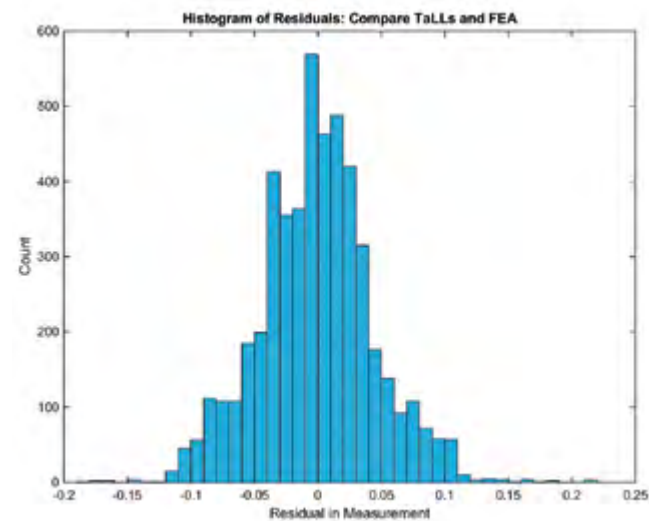

FIGURE 3(A).
Histogram of all residuals in all directions.

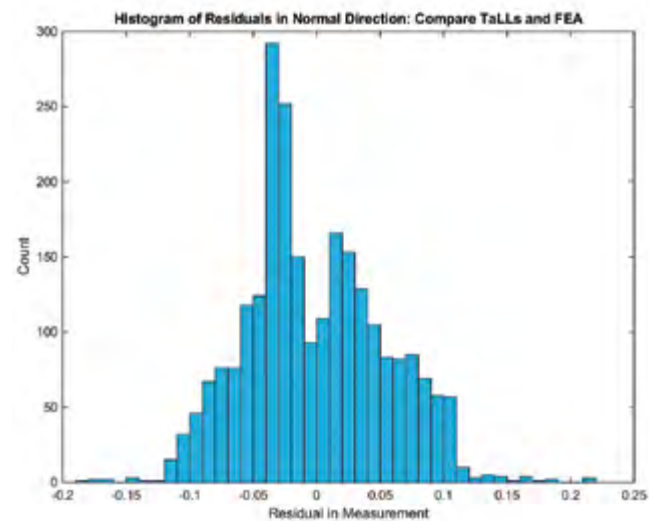

FIGURE 3(B).
Histogram of residuals in the normal direction.



AIRCRAFT IN ASSEMBLY

A 787-10 fuselage in early stages of the alignment and joining process.

PHOTO: BOEING, ALAN MARTS

locations are given in terms of azimuth around the fuselage barrel, with the convention that the crown of the barrel is set at -180 degrees, increasing counterclockwise to 0 degrees at the keel and back to 180 degrees at the crown again.

A fuselage section was used in our experiment. There are 10 control nodes, 241 response nodes from the Targetless Laser Locator System (TaLLs) and 71 from FEA. Although forces were only applied in the normal direction so that displacements in the tangential direction are small and can be ignored, displacements in both directions were recorded and analyzed.

In addition, locations of response node results from FEA are smaller than those of TaLLs. A smooth spline model is used to interpolate the displacements simulated by FEA to the response locations taken by TaLLs so the differences can be computed.

To perform the analysis, we took advantage of the software tool Joint Fuselage Analysis Matlab Tool developed by Mark Abramson under the Boeing Active Cradle Project.

Below are the steps we performed:

- Run Joint Fuselage Analysis Matlab Tool on fuselage section test by loading data from both FEA simulation and TaLLs measurements.
- Extract system matrices and response nodes.
- Construct a spline model for each column of the system matrix of FEA simulation and interpolate the model with the response nodes from TaLLs.
- Compute the component-wise residual.

In this report, we described the mathematical model for an active cradle system to achieve desired displacements all around the aircraft barrel to align the sections for attachment.

Most importantly, we established conditions under which no material damage will occur, and we reported the choice of threshold parameters that governs these conditions. A full accounting and mathematical proofs are available in the full paper online. **IQ**

To read and download the complete Boeing Technical Journal paper titled:

“Model and Analysis of an Active Cradle System”

Please visit boeing.com/IQ.

Surface Smoothing of Powder Bed Fusion Additive Manufactured Ti-6Al-4V Components

Summary

BY MATTHEW R. SOJA | K. CHANNA R. DE SILVA

Metallic powder bed fusion (PBF) additive manufacturing (AM) processes for Ti-6Al-4V enables fabrication of complex geometries that are not practical using traditional manufacturing processes.

However, the as-deposited surface finish is rough and causes design form, fit and function challenges; impacts mechanical properties (including fatigue life reduction); and impacts the resolution of non-destructive inspection imaging.

While there are a relatively small number of potential part applications which are non-fatigue critical, many more part application opportunities exist for aircraft components with fatigue strength requirements. Conventional machining of rough surfaces is effective, however costly when applied to complex geometries, such as those enabled by PBF AM.

As such, the as-deposited AM surface quality is a significant barrier for widespread application of the powder bed fusion technology for aircraft components, especially for structures with fatigue and damage tolerance requirements.

While efforts are in work to improve the as-printed surface condition through the laser PBF printing process, this study focuses on using post-processing surface smoothing methods.

Several commercially available surface smoothing processes have been evaluated as alternatives to machining based on their ability to improve the fatigue life and mitigate the form, fit and function issues. While processing cost and flow time are critical elements to selecting a viable solution, this project is primarily focused on technical performance of the

smoothing technologies to help identify a path forward for future development.

All parts used in this study were fabricated from Ti-6Al-4V using laser PBF AM, followed by stress relief and hot isostatic pressing (HIP). All static and fatigue test coupons were fabricated within one AM build cycle to eliminate build-to-build variability that could complicate the ability to compare static or fatigue test results.

Prior to surface smoothing, radiographic inspection was performed on a sampling of test coupons to verify internal material quality. These inspections are intended to check for the presence of porosity or lack of fusion in the material that could impact static and fatigue test results. The laser PBF AM processes utilized here are prone to these types of defects, which could result from a variety of powder, machine or print process parameter issues.

Fatigue performance is especially sensitive to the presence of these types of defects that act as stress concentrations and crack nucleation sites within the material. In order to enable comparison of relative fatigue life data, it is imperative that the printed test coupon material is of high quality, free from defects and is consistent across the lot of coupons used.

These inspections are intended to check for the presence of porosity or lack of fusion in the material that could impact static and fatigue test results.

Three commercial surface-smoothing procedures were selected for evaluation. Process I utilizes an abrasive process, whereas Process II and Process III are similar to chemical metal removal processes. In addition, two hybrid surface-smoothing processes were evaluated, where individual surface smoothing processes were performed in series.

According to surface relative roughness average, or Ra, measurements in Figure 17 and Figure 18, utilizing abrasive Process I as a secondary surface finishing step recorded the best surface Ra values for both the fatigue specimens and demonstrator

parts. While Process I generates what appears to be a homogeneous surface based on lower-resolution imaging or profilometry using standard surface roughness parameters, the Scanning Electron Microscope (SEM) images on the next page indicate the presence of additional surface features.

The chemical-and-abrasive Process V hybrid surface smoothing was superior in surface roughness to both its constituent Process I and Process IIa components applied individually to the cylindrical fatigue specimens. While this is also true for the demonstrator part surfaces evaluated, abrasive Process I applied by itself to

the configured part performed nearly as well as the hybrid chemical-and-abrasive Process V. This inconsistency may be due to part geometry and/or orientation differences between the two scenarios, as well as the ability of the Process I to more easily address flat or planar surfaces.

Similarly, chemical Process III resulted in a significant improvement in surface roughness relative to chemical Processes IIa or IIb for the demonstration parts. However for fatigue test specimens, the surface finish results were comparable. For chemical Process II, the addition of a Process IIb showed a consistent

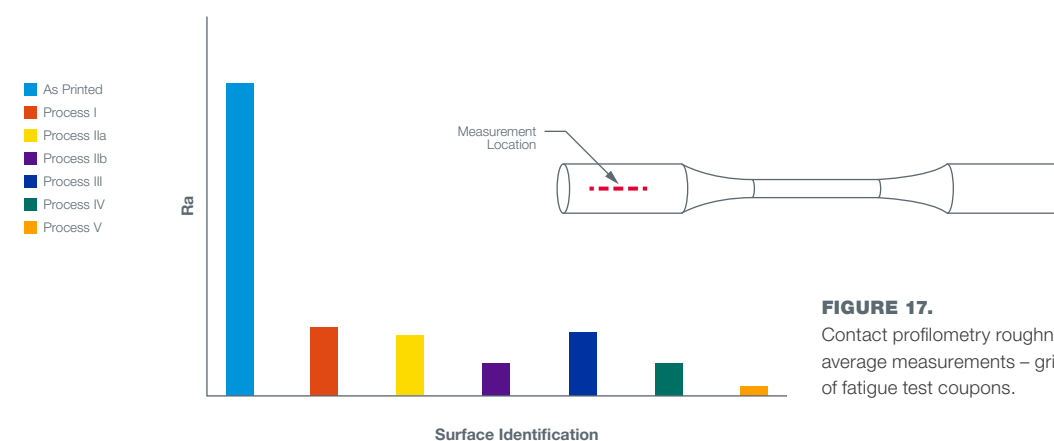

FIGURE 17. Contact profilometry roughness average measurements – grip ends of fatigue test coupons.

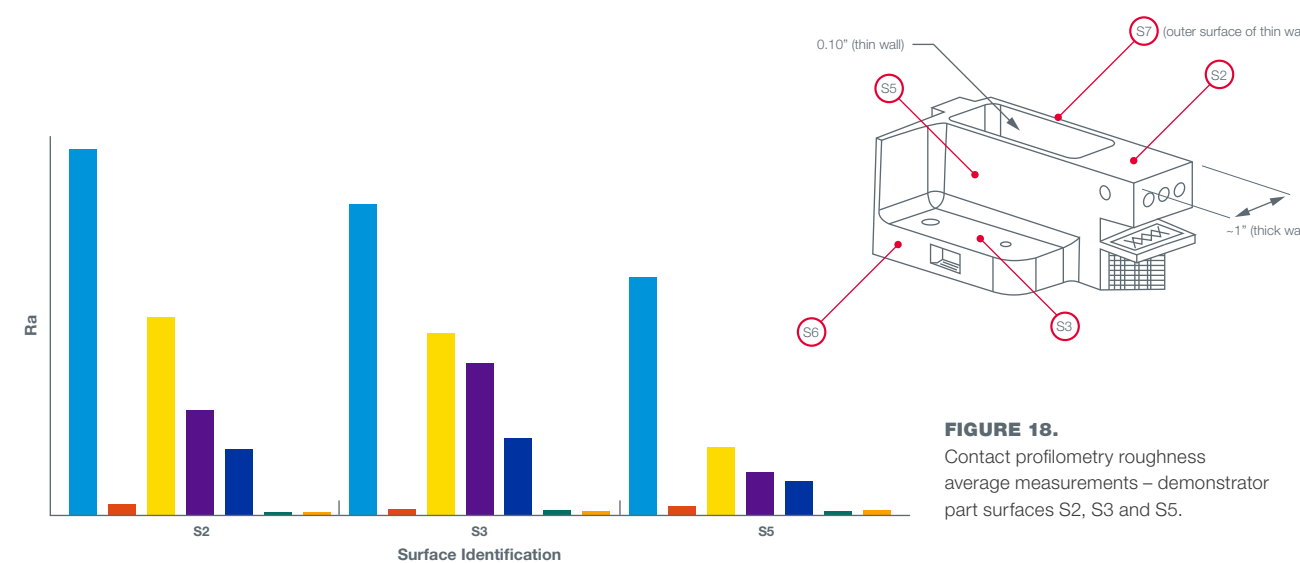

FIGURE 18. Contact profilometry roughness average measurements – demonstrator part surfaces S2, S3 and S5.

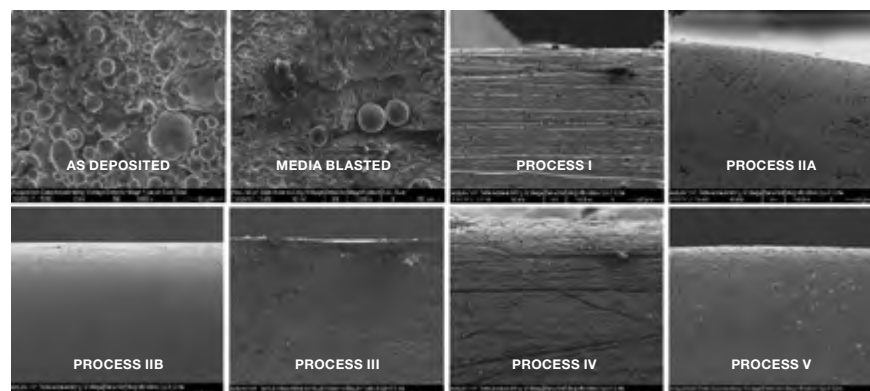

PHOTO: BOEING

Summary descriptions of each commercial and hybrid smoothing process evaluated

Process I

Is an abrasive smoothing technology.

Process II

Employs two different smoothing processes. One is a chemical metal removal process identified as Process IIa; the other is a combination of Process IIa and chemical-mechanical metal removal identified as Process IIb.

Process III

Is a chemical metal-removal process and has no limitations on material thickness removal. As such, this process was evaluated due to its capability to remove material beyond the total roughness and perhaps remove subsurface defects.

Process IV

Includes a batch of as-printed parts and test coupons that were pre-treated with dry abrasive media blasting. Since Process I is only capable of removing a minimal amount of surface material, media blast pre-processing was applied to reduce the initial surface roughness for Process I to enhance surface material removal.

Process V

Is another hybrid approach. Between the two steps employed by Process II, the chemical process component (Process IIa) is mainly responsible for material removal. And the abrasive Process I component is meant to target aesthetic improvement. Based on prior evaluation of electron beam powder bed fusion Ti-6Al-4V parts, it was observed that Process I can generate uniform surfaces. As such, the combination of Process IIa, followed by Process I was evaluated.

improvement in surface roughness for all geometries evaluated.

Both Process II and Process III, which are chemical based, have no limitation in the amount of material that can be removed. Chemical metal removal processes can address support structure interfaces or residual rash. However, this requires significant material removal from targeted surfaces which requires masking and other controls to ensure geometric stability of the finished part. Abrasive processes such as Process I are not viable options for addressing support structure interfaces. The final surface quality achieved by all commercial processes are geometry-dependent and require fixturing and varying orientation inside a process tank for optimal results. Chemical metal removal processes are relatively inexpensive compared to abrasive processes, but carry with them the associated risks with handling hazardous chemicals.

Prior to fatigue testing, static test of both as-printed and machined surface tensile coupons was performed to establish static strength properties for the baseline surface conditions and facilitate selection of initial fatigue test stress levels. Testing was performed per ASTM E8, and a constant displacement rate was utilized through failure of the test coupons. Baseline fatigue test values were generated per ASTM E466 for both the as-printed and machined surface conditions to serve as a basis of comparison for surface-smoothed fatigue test results.

While the as-printed surface fatigue life is significantly lower than that of machined, the results are generally consistent with good repeatability as indicated by stress levels for which multiple test replicates were performed. The machined surface

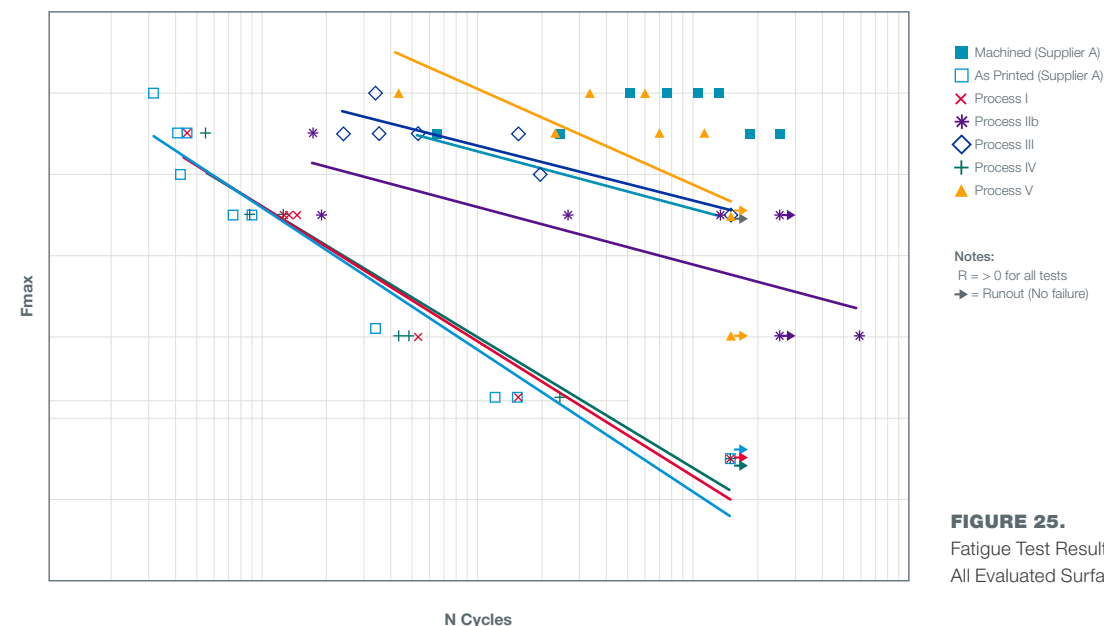

FIGURE 25.
Fatigue Test Results –
All Evaluated Surfaces.

performance is better relative to as-printed, but far less consistent.

Figure 25 presents all fatigue test results and associated curve fits for the as-printed, machined and five surface-smoothing conditions evaluated.

In general, fatigue life of the surface-smoothed test coupons varied significantly between the two abrasive and three chemical smoothing processes evaluated. In addition, standard surface roughness measurement parameters (R_a , R_t) do not correlate with fatigue life performance observed, as these surface roughness parameters do not capture the effects of distributed surface and subsurface features which drive fatigue life.

The abrasive surface-smoothing processes (Process I and Process IV) did not exhibit any measureable fatigue life improvement over the baseline as-printed surface.

In contrast, the chemical-smoothing-based processes (Process IIb, Process III and Process V) showed

a significant improvement in fatigue life relative to the as-printed surface. Both the chemical Process III and hybrid chemical-and-abrasive Process V treated surfaces showed fatigue life performance similar to that of machined surfaces.

Secondary surface smoothing, as with that employed with hybrid chemical-and-abrasive Process V, produces a more consistent and pit-free final surface which is capable of fatigue life similar to that of a fully machined surface.

Although fatigue life performance of laser PBF Ti-6Al-4V is dramatically limited by the rough as-printed surface, non-machining smoothing processes that are capable of fully removing the rough outer layer of as-printed material can achieve fatigue life performance similar to that of a fully machined surface. **IQ**

To read and download the complete Boeing Technical Journal paper titled:

“Surface Smoothing of Powder Bed Fusion Additive Manufactured Ti-6Al-4V Components”

Please visit boeing.com/IQ.

“Choosing the right machine learning algorithm is a balancing act based on our business goals, the desired accuracy, scalability and speed of predictions.”

SRINI VENKATRAMAN,
DATA SCIENCE AND ANALYTICS MANAGER

PHOTOS: BOEING, JOSH DRAKE



TESTING THE MACHINE LEARNING

Industrial engineer Margaret Eicks validates the machine by turning it on and off at the right hole locations from the early fastener feed predicted model. This test confirms that the file being sent to the machine is being captured, read and communicated to the machine correctly.

Artificial intelligence, machine learning advances hit factory floor

Introduction of automated technology saves even more time in assembly.

BY HILARY SOLAN, BOEING WRITER

Technologists from across Boeing are using artificial intelligence to drive even more efficiency from precision automation equipment assembling aircraft in South Carolina.

The advances, supporting fuselage section assemblies for the 787, are greatly improving the productivity of four German Broetje-Automation skin-fastening machines, equipment that is already highly engineered and specialized for aerospace production.

Srini Venkatraman, whose artificial intelligence and machine learning team has developed machine-learning models, used clustering and genetic algorithms to introduce predictive capabilities to the early fastener feed feature of the Broetje machines.

“Previously, the Broetje mechanics manually turned on/off the early fastener feed feature based on their individual experience and judgment, but with limited usage and success,” Venkatraman said. “The introduction of

automated early fastener feed technology has been saving up to five hours of flow for each line since April.”

Originally, the machines drilled and filled in a time-consuming process; however, this new solution has created a predictive model. These machines perform drilling/countersinking, sealant application, fastener insertion, collar swaging, positioning sensors and early fastener feed.

“As part of the work, we developed machine learning models using model-based clustering and generic algorithms to cluster the grip-length of the fasteners from historical data and predict when the early fastener feed can be turned on and for how many continuous holes,” Venkatraman said.

Savings have increased as the machine-learning models are constantly learning from new data, and data scientists believe there’s potential to get even faster and more accurate.

Even more exciting, Venkatraman said, is the potential for reuse and replication of the techniques in other Boeing production facilities. This includes not just the other skin-fastening machines but anywhere predictive capabilities can be used.

“Choosing the right machine learning algorithm is a balancing act based on our business goals, the desired accuracy, scalability and speed of predictions. It required us to try many different algorithms to come up with the most optimal option. At the same time, we needed something generalizable across the other factory machines,” Venkatraman said.

Margaret Eicks, an industrial engineer, and Michael Rojas, a data scientist, are teaming up to replicate the machine-learning technology across other automation cells: for example, the Quadbot machines supporting parts of the 787 fuselage section assemblies. Meanwhile, development work has begun for replication on Boeing’s Flex Track machines, as well.

Rojas, Eicks, safety engineer Fletcher Burgess and database analyst Michael Honea at Boeing South Carolina, along with data scientist Sayantan Chattopadhyay in Bangalore, India, collaborated across international time zones for the initial work.

In the immediate future, the team wants to see how it can reuse this model to drive other predictive capabilities across 787 aft body to support 787 rate increase. Long term, the team wants to replicate and expand this work to other aircraft production programs. **IQ**



PHOTO: COURTESY MANUEL KURTH.CH



PHOTO: BOEING

Spreading
the word to
change
the world



PHOTO: CHRIS MILLER



PHOTO: BOEING



PHOTO: BOEING

From the top, left to right:

WORLD ECONOMIC FORUM

Boeing Chairman, President and CEO Dennis Muilenburg (right) discussed the future of mobility with UPS Chairman and CEO David Abney and Uber CEO Dara Khosrowshahi in Davos Klosters, Switzerland.

INSPIRING A DIVERSE SCIENTIFIC COMMUNITY

Chang Hyun Son, Boeing mechanical system design and analysis engineer, speaks at the 2018 Society of Asian Scientists and Engineers conference, where he was honored for his community service efforts.

TAKING A STEM INITIATIVE

Chris Miller, a Boeing flight simulations lab manager, shows students how to fly using his portable simulator. Miller received the 2019 Chairman's Award for Employee Community Engagement for getting students interested in science, technology, engineering and math.

PARTNERSHIP WITH JAPAN

Greg Hyslop, Boeing chief technology officer, and Yoshihiko Isozaki, Japan's state minister for Economy, Trade and Industry (left), announce a collaboration on research and development related to electric propulsion, automation and future mobility technologies.

RAMPING UP ASSEMBLY RATE

Employees at Boeing South Carolina and other volunteers put together bikes as part of the company's Spirit of the Holidays drive during the recent holiday season. The group put together more than 300 bikes in three hours.

Advanced
materials take
wing over a
century of flight

From fabric to carbon fiber

Walk through the Composite Wing Center in Everett, Washington, where autoclaves will cure the massive carbon fiber wings of the 777X widebody jetliner, and try to imagine an airplane wing being made instead by hand with needle and thread.

Turn back the clock to 1916, and that's exactly what you would see. In what became known as the Red Barn, The Boeing Company's first building in Seattle, seamstresses created the skin for the wood-frame biplane wings by sewing together heavy linen fabric with long needles and thread.

Founder William Boeing personally hired the company's first woman employee, seamstress Rosie Farrar.

Wood-and-fabric airplanes first started to give way to stronger, better-performing metal-frame and aluminum-skin aircraft in 1929, in a transformation that was mostly complete by the late 1930s.

Turn the clock forward a few decades, and the pace of innovation accelerates, until today when new technology and advanced metals, such as titanium and lightweight aluminum alloys, continue to expand the possibilities of aircraft design and manufacture.

One of the most significant advances in aviation materials, of course, is composites made with strands of carbon fiber, which are enabling new generations of stronger, lighter, more efficient and better performing Boeing aircraft, such as the 777X. **IQ**

-PATRICK SUMMERS



PHOTO: BOEING

FIBERS OF HISTORY

Seamstresses in Seattle 100 years ago sewed linen over wooden frames to create the wings of the first Boeing aircraft.



PHOTO: BOEING

THE FIBER OF TODAY

Technologists use advanced tooling and equipment to create carbon fiber laminates for the Boeing aircraft of today.

A young man with dark hair, wearing a blue denim shirt, is focused on working on a robotic device. The device has a prominent red light and various wires and components. The background is blurred, suggesting an indoor setting like a workshop or classroom.

INSPIRED MINDS INSPIRE THE WORLD.

Inspiration starts young. And when we come together, there is no limit to what we can do. Boeing is proud to encourage young minds to tackle the challenges of tomorrow, today.

 **BOEING**