

# IQ

# INNOVATION QUARTERLY

INNOVATION. INSIGHT. INSIDE AEROSPACE.

# Metal Man

**Award-winning  
engineer keeps  
it simple**

**Sustainability Is Built In**  
Boeing's product life cycle,  
every step of the way

**Defiantly Different**  
Four ways DEFIANT X  
defies convention

**Libation to Innovation**  
A beer keg inspires  
aviation history

**MIND OVER MATERIALS**

Dr. Alain Adjorlolo in front of a  
787 Dreamliner. His ideas are used  
in the production of every one.

**PLUS:**

How a missile launch  
is like a waterfall

**PUBLISHER**

Greg Hyslop  
Chief Engineer

**EDITORIAL DIRECTOR**

Gary Wicks

**EDITOR**

Michael King

**DEPUTY EDITOR**

Ed Muir

**DIGITAL EDITOR**

Vienna Catalani

**CONTRIBUTING EDITORS**

Justin Gibson, Melanie de Git, Rob Gross,  
Randy Jackson, Whitney Jones,  
Rachelle Lockhart, Lori Rasmussen,  
Josh Roth, Dee Russell

**PROJECT MANAGER**

Ben Jackson

**CREATIVE LEAD**

Clayton Chu

**DESIGN TEAM**

Bruce Burton, William Crane,  
Vaughn Hale, Shayla Hufana,  
Tony Ly, Kevin Mau

**COPY EDITOR**

Teresa Stanker

**DIGITAL TEAM**

Christopher Barrett, Jan Bartko,  
Diane Foshage, Casey Gilman,  
Shipra Gupta

**LEGAL ADVISER**

Tom Donahue

**COVER PHOTO**

Marian Lockhart

**JOIN US**

jobs.boeing.com

**LET'S TALK**

Feedback is welcome and may  
be published in a subsequent issue:  
IQ@exchange.boeing.com

**IQ IN YOUR INBOX**

Sign up at Boeing.com/IQ



**Sustainability  
Is Built In**

Boeing's product life cycle,  
every step of the way.



**Metal Man**

Award-winning engineer  
keeps it simple.



**Defiantly Different**

Four ways DEFIANT X  
defies convention.

**16 | Tech R.A.D.A.R.: Global Innovation**

From robot tigers to Red Hawks to printing in space.

**32 | TimeTravel: Libation to Innovation**

A beer keg inspires aviation history.

**36 | Q&A: Cyber Security Guard**

Tips from a product security engineer.

**40 | PatentPower**

Ultraviolet disinfection and interference reduction.

**42 | Engineer Training That Works**

New methods for modern learners.

**44 | Out&About: Starliner Star**

One hundred gallons of lifesaving love.

**46 | Insight: Spring-Loaded Innovation**

How to get there and stay there.

**50 | TopShot: Night Light**

Minuteman III up, up and away.



**Uncompromising**  
commitment

**We all have choices to make.** Whether it's a quick request, an everyday moment or a major milestone, we make a call: pivot or commit. In order to move forward, to achieve, to excel, we must determine a course of action. And once an informed decision is made, we stay that course. This uncompromising commitment appears on every page of this issue of Innovation Quarterly.

In 2020, Boeing chose to put additional emphasis on sustainability by formalizing an organization focused on environmental stewardship, social progress, and values-based and transparent governance. In this edition, we explore how sustainability is built into every stage of our product life cycle and how engineering and sustainability must be integral parts of the process, as essential and routine as a nut or bolt.

Another story features engineer Alain Adjorlolo and his commitment to simplicity in the midst of complex manufacturing processes. His approach furthers quality and safety.

We are committed to meeting our customers' needs with DEFIANT X. The advanced utility helicopter and air assault weapon system can fly low and fast, land quickly, deliver soldiers to the objective area (known as the "X") and get out — all while evading the enemy in complex terrain.

Also in this issue, our team members have demonstrated their commitment to resourceful innovation in the 1930s, to cybersecurity today and to the health of humankind, more tangible ties to Boeing's uncompromising commitment to sustainability.

We assess, commit and deliver — safely and sustainably. **IQ**

**Chris Raymond**  
Chief Sustainability Officer

# SUSTAINABILITY IS BUILT IN

## Boeing's product life cycle, every step of the way

BY LISA MAULL, PAUL MCELROY AND JOANNA WINGBERMUEHLE, BOEING WRITERS

**In California**, the low hum of a 3D printer stops — a satellite part is unveiled that will soon orbit in space. A unique ecosystem in the United Arab Emirates makes airplane fuel using land where food won't grow and using water we can't drink. Excess carbon fiber from making wing components for the new Boeing 777X could become a laptop case or even a wind turbine blade — and possibly be used by the next generation of innovators to make the world a better place.

To survive and thrive in today's world, aerospace must consider the world itself. From a customer's initial request to the creation of the aircraft or product to its use and eventual retirement, every stage along the way can be engineered with Earth and all its inhabitants in mind.

This is Boeing's life-cycle approach: Design, build and deliver each of its products and services with the highest standards of safety, quality and integrity.

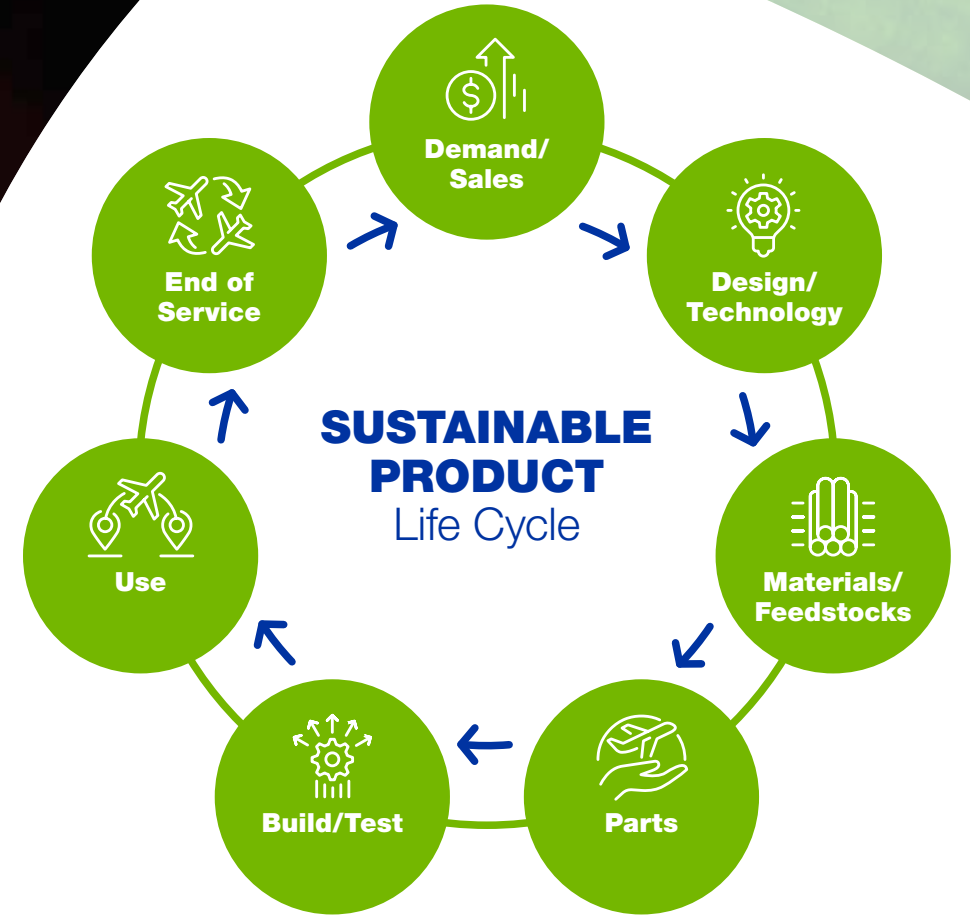

### DATA DECISIONS

Jeppesen FliteDeck Pro provides pilots with real-time flight information, including routing and weather data that is used to enhance decision-making and fuel-efficient flight operations.

PHOTO: BOEING



**WINGS OF CHANGE**

With new breakthroughs in aerodynamics and engines, the 777X will deliver 10% lower fuel use and emissions and 10% lower operating costs than the competition.

PHOTO: PAUL WEATHERMAN/BOEING



“ Whether we’re finding solutions to keep our employees and passengers safe, reduce our carbon footprint, source responsibly or serve our communities — we ensure that sustainability is built in during every step of the product’s life cycle. ”

**DR. BRIAN YUTKO, CHIEF ENGINEER, SUSTAINABILITY AND FUTURE MOBILITY**

## SUSTAINABILITY STARTS AT THE BEGINNING AND NEVER STOPS.

**DEMAND/SALES**

Airlines have always demanded airplanes with the highest fuel efficiency and best environmental performance possible. That continues today as demand for lower emissions has increased — and airlines have accelerated the retirement of older, less-efficient aircraft during the pandemic. Through technological improvements and innovation, Boeing calculates that each generation of its commercial airplanes is 15% to 25% more efficient than the generation before.

“ Improving efficiency makes flying more economical for airlines, affordable for more travelers and better for the environment. ”

**SHEILA REMES**

Vice president, Environmental Sustainability

## ADDITION BY SUBTRACTION

Additive manufacturing, also known as 3D printing, is a process that creates sustainable products by using less raw material (reducing mining, conversion and transportation), printing at the point of use and reducing the weight, thereby minimizing the carbon footprint during the end-to-end life cycle.

A recent example realized by Boeing is the additive-manufactured deployable ion engine mount for a recently launched 702MP satellite, made from powder-bed laser fusion of aluminum alloy AlSi10Mg.

“Additive manufacturing allowed an optimized design, which placed material only where it was required to support the loads, resulting in a 28-pound reduction in weight of the part while simultaneously eliminating almost all of the scrap associated with traditional manufacturing.”

**DR. MELISSA ORME**  
Vice president, Boeing Additive Manufacturing



## DESIGN/TECHNOLOGY

A majority of the environmental impact of a technology's or product's life cycle is determined in the design phase. Boeing embeds sustainability into its design process and conducts life-cycle assessments to ensure aircraft design and new technologies are safe and sustainable.

“There is no time like the present to design for a sustainable future. Our design decisions today influence the raw materials we procure, the parts we machine, and the products we build and fly for decades to come.”

### CHRISTIN DATZ

Lead engineer, Environmental Sustainability, Product Development, and Boeing's 2020 Environment Champion

## LIGHTER SATELLITE

The upper Y bracket is one of three 3D-printed parts on the deployable ion engine mount for a recently launched satellite. Additive manufacturing optimized the design — printing material only where needed — resulting in an overall 28-pound reduction, which means less energy required for launch. The hollow form with geometric cutouts also uses less aluminum and minimizes scrap material that would be wasted when traditionally manufactured as a solid part.

PHOTO: BOEING



## MATERIALS/FEEDSTOCKS

When selecting the materials that go into its products, Boeing identifies opportunities for eliminating, capturing and recycling solvents and chemicals while developing alternative materials, primers and coatings. Boeing is also developing materials with increased recycled and renewable content.

“Matter matters. We have the opportunity to design products with more-efficient materials — selecting materials that can be reused and recycled. When we pay attention to the materials used early in the process, there is so much we can do to benefit the planet.”

### DR. TIA BENSON TOLLE

Director, Advanced Materials and Sustainability, Product Development



## PARTS

Boeing is committed to working with suppliers to source responsibly; create economic opportunity for diverse communities; and drive industry sustainability progress in social, environmental and governance aspects. So sustainability is not just responsibly using resources in terms of the planet; it's also responsibly obtaining resources for those who live on Earth now and in the future.

“A Boeing commercial aircraft is comprised of millions of parts — 2.3 million for the 787. Whether the part is made internally or comes from our suppliers, each is an opportunity to consider our impact and how we can continue to drive towards environmental considerations. Every little change matters and is a step toward our future, from the nuts and bolts to the engines to the people who provide the parts.”

### ERIN GUTIERREZ

Manager, Environmental Sustainability & External Collaboration, Product Development

## PLAN OF ACTION

Boeing Australia has a growing commitment to creating a better future for Aboriginal and Torres Strait Islander peoples, in part by working with Indigenous-owned businesses through Boeing Reconciliation Action Plans and maximizing Australian industry content in the supply chain.

As of April 2021, Boeing Defence Australia achieved more than 17 million Australian dollars in accumulated Indigenous supply chain spend since 2012 as part of its growing relationship with Supply Nation, which connects companies with Indigenous suppliers like the Indigenous Defence & Infrastructure Consortium. One of many milestones was Boeing's work with the first Indigenous-owned business in Australia to become qualified to audit or certify under AS9100, the international quality management system standard for the aerospace industry.

“Diversity is core to The Boeing Company's values, allowing us to provide innovative solutions to our customers. Our Reconciliation Action Plan is a clear demonstration of our determination to prepare Indigenous-owned businesses for growth in new and existing domestic and international markets.”

### SCOTT CARPENDALE

Vice president and managing director, Boeing Defence Australia



#### SOLAR ROOF

Nearly 10 acres of solar panels installed on top of Boeing South Carolina's Final Assembly building have helped provide sustainable power to the site for nearly a decade.

PHOTO: BOEING



#### BUILD/TEST

Boeing continues to improve the sustainability of its manufacturing processes and is committed to reducing emissions across its operations, including at production sites. The 787 Final Assembly building in South Carolina, for example, has nearly 10 acres of solar panels on its roof. Boeing South Carolina is also a zero-waste-to-landfill site, meaning everything from packaging to paper cups is recycled, reused or repurposed.

To support sustainable manufacturing, Boeing works with U.K.-based ELG Carbon Fibre Ltd. to recycle excess carbon-fiber material from the airplane assembly process. This first-of-its-kind partnership prevents about 1 million pounds of waste a year from going to landfills. The renewed carbon fiber is used by manufacturers to make computer laptop cases, automobile parts and other products. These efforts are rapidly developing into a scalable supply chain.

“After a decade working with academia and industry, there are now solutions to the excess carbon-fiber composite waste challenge. Removing the cured resin without damaging the valuable aerospace-grade carbon fiber frees it up to provide the same performance attributes we value to non-aerospace applications.”

**PETE GEORGE, PROJECT ENGINEER AND ASSOCIATE TECHNICAL FELLOW, ADVANCED MATERIALS, PRODUCT DEVELOPMENT**



PHOTO: BOEING

#### EYE ON EFFICIENCY

Boeing's newest twin-aisle airplane, the 777X, began flight testing in 2020. Through advanced aerodynamics, latest-generation carbon-fiber composite wings and advanced General Electric GE9X engines, the 777X is designed to be the most fuel-efficient twin-engine jetliner in the world.

## REAL-TIME REROUTE

Boeing uses data analytics to help airlines plan the most efficient flight routing. The Fuel Dashboard service analyzes how airplanes are flown to determine optimal speeds, altitudes and other factors to improve efficiency and reduce emissions. Apps for pilots provide real-time information about weather and traffic, enabling faster rerouting when conditions change during the flight.

Boeing also works with air navigation service providers on procedures such as continuous descent approaches and infrastructure upgrades to implement GPS-based navigation for more direct routings and better airspace efficiency to accommodate future growth.



### DIGITAL DIRECTION

Boeing IT manager Abbey Donley works to ensure airline customers' success via digital tools that collect, analyze and leverage insights to improve safety and reliability, increase efficiency in maintenance work and lower operating costs.

This photo was taken before Boeing implemented COVID-19 pandemic safeguards.

PHOTO: BOB FERGUSON/BOEING



### USE

Boeing's responsibility and support doesn't end when an aircraft rolls out of the factory. Given most carbon emissions of the aircraft occur during use, Boeing continues to focus on a portfolio of solutions, including operational efficiencies, new technologies and renewable energy transition to reduce carbon emissions during this stage of the life cycle.

For example, Boeing's pioneering role in making sustainable aviation fuel a reality dates back to 2008, when test flights conducted with airline customers helped gain certification for its commercial use. The ecoDemonstrator program has used sustainable aviation fuel on each of its flight test programs since 2012 and also conducts test flights for fuels that are not yet approved for commercial use to help expand the potential sustainable fuel supply base.

In 2018, the ecoDemonstrator, in collaboration with FedEx, flew the world's first commercial airplane using 100% sustainable aviation fuels.

**“Boeing has been a pioneer in making sustainable aviation fuels a reality. We were centrally involved with initial testing and approval for commercial use and continue to research ways to scale up supplies from different feedstocks.”**

### SEAN NEWSUM

Director, Sustainability Strategy

**“Within Boeing's digital services, we offer several products that help our customers increase efficiency and reduce fuel consumption, so their fleets operate more sustainably. Products such as Jeppesen Fuel Dashboard, Emissions Reporter and Wind Updates give airlines and pilots visibility into real-time effects on their fuel usage and emissions so they can reduce them, which is better for the environment and for the bottom line.”**

### DUANE WEHKING

Boeing Global Services  
vice president, Digital  
Solutions and IT Services



### SOUND THINKING

In collaboration with Etihad Airways and Safran Landing Systems, Boeing tested landing gear modified to be quieter on the 2020 ecoDemonstrator 787-10.

PHOTO: PAUL WEATHERMAN/BOEING

## LASER FOCUS

While in use, airplanes need to have their coatings removed about every five years. Instead of using a sander or chemical process, Boeing developed lasers to remove the paint, which improves the quality and speed of the work while also reducing waste and the ergonomic risk to employees.

**“Laser ablation offers a paradigm shift away from traditional methods that pose risks to people and the environment. Lasers are attractive because right-sized systems can meet or exceed current rates while saving cost and reducing more than 90% of hazardous waste generated by other methods. That makes them a key part of Boeing's strategy as an environmental leader.”**

### DR. KADY GREGERSEN

Research engineer, Chemical  
Technology; Associate Technical  
Fellow; and Boeing Designated  
Expert for laser depainting



### LASER FOCUSED

Laser ablation removed the yellowish-green paint in a tight circle on this aluminum aircraft part.

PHOTO: KADY GREGERSEN/BOEING

## SURPLUS PLUS

Recertified parts from retired airplanes help customers reduce the cost of repairs while offering cost-efficient quality solutions. Boeing Global Services provides access to this inventory, called used serviceable material — or USM. Boeing recertifies the parts, ensuring quality.

Materials have been harvested from retired Boeing airplanes, including the 767 and 737, as well as non-Boeing-manufactured aircraft. Boeing is a founding member of the Aircraft Fleet Recycling Association, the leading global organization for developing and promoting the safe and sustainable management of component and aircraft circularity in the aviation sector. One dismantled airplane can provide up to 6,000 parts.

“Boeing is contributing to reducing waste by recertifying and reusing airplane parts. In addition to retired airplanes providing recycled parts for in-service aircraft, we are helping customers reduce the cost of repairs by offering cost-efficient, quality options for parts at reduced prices and more inventory access.”

**JOHN BROOKS**  
Senior manager,  
Used Serviceable Material



## END OF SERVICE

Boeing's commercial airplane designs enable parts disassembly and materials recovery. As a result, Boeing airplanes are nearly 90% reusable or recyclable by weight.

# THE FUTURE IS BRIGHT — AND DIGITAL.

**Some solutions** affect many aspects of the life cycle. There is a particularly prevalent intersection between digital engineering and sustainability. The U.S. Air Force designated the T-7A Red Hawk advanced trainer as the first in its digital “eSeries.” Embracing model-based engineering and 3D design tools, the T-7A achieved an 80% reduction in assembly hours and a 75% increase in first-time engineering quality, as well as cut software development time in half. With digital engineering, more testing is done in the simulator.



## FIRST FLIGHT OF THE FUTURE

The uncrewed Loyal Wingman recently completed its first voyage in Australia. The project used a digital twin to flight-test missions and advance from design to flight in three years.

PHOTO: COMMONWEALTH OF AUSTRALIA, DEPARTMENT OF DEFENCE/CPL. CRAIG BARRETT

## DIGITAL PIONEER

The T-7A is the first in the U.S. Air Force's new digital eSeries of aircraft, weapons, satellites and assets — designed and built along a digital thread that embraces advanced manufacturing techniques to improve quality and enhance performance.

GRAPHIC: BOEING

Boeing has also used this type of innovation on the Airpower Teaming System uncrewed aircraft being developed with the Royal Australian Air Force. The Loyal Wingman recently completed its first test flight under the supervision of a Boeing test pilot monitoring the aircraft from a ground control station at the Woomera Range Complex.

As Boeing ensures its products and services are safe and sustainable for future generations, it will continue to work with industry and community partners worldwide.

Boeing has joined with the International Civil Aviation Organization and other industry groups, academia and cross-sector businesses to tackle global challenges. Among these many partnerships, Boeing is a founding member of Villanova RISE (Resilient Innovation through Sustainable Engineering) Forum and member of the MIT Climate and Sustainability Consortium.

Every sector, business, technology, researcher and country has a part to play — a shared responsibility. Global challenges require global solutions. **IQ**

“We had already flown the [T-7A] in the simulator using the exact same digital software many times rehearsing for [the first] flight. So when it comes to the real thing, we know what to expect — the jet flew exactly as it was supposed to, no surprises.”

**DAN DRAEGER, CHIEF TACTICAL AIRCRAFT TEST PILOT, BOEING TEST & EVALUATION**



**Boeing's Foresight and Technology Intelligence Community of Practice tracks innovation around the world.**

tech

**R.A.D.A.R.**

**Recognizing Advanced Developments and Research**

 **Carbon Bye-Oxide**

**Squamish, British Columbia**

A new carbon dioxide removal service launched by Carbon Engineering allows customers to purchase removal of carbon dioxide. A direct air capture facility removes carbon dioxide from the atmosphere and puts it underground.

 **Digital Design Pioneer**

**St. Louis**

A new era of aircraft design and assembly began as the T-7A Red Hawk advanced trainer entered production. Fully designed digitally, the jet went from concept to first flight in just 36 months.

 **Space 3D Printing**

**Cologne, Germany**

A vision for space exploration could enhance self-sustainability using in-space 3D printing to maintain, repair and produce objects without ground support. The notion is described in a paper from the Institute for Materials Physics in Space, among others.

 **Green Means Go**

**Warsaw, Poland**

A "green" satellite thruster fired for 60 seconds at Poland's Institute of Aviation. The test evaluated a biopropellant combination using concentrated hydrogen peroxide to potentially identify more environmentally friendly thruster options.

 **Robotic Tiger**

**Seoul, South Korea**

An experimental vehicle known as TIGER (transforming intelligent ground excursion robot) can carry loads in extreme, remote locations. The uncrewed machine features four legs that extend or retract to "walk" over previously inaccessible terrain.

 **Loyal Wingman First Flight**

**RAAF Woomera Range, South Australia**

The first Loyal Wingman completed its inaugural voyage, successfully taking off before flying a set route under the supervision of a test pilot on the ground. The uncrewed aircraft advanced Boeing Australia's and the Royal Australian Air Force's teaming aircraft program.

# METAL MAN

## AWARD-WINNING ENGINEER KEEPS IT SIMPLE

BY JILL HULINGS, BOEING WRITER

During routine 787 Dreamliner flight tests a decade ago, pilots were startled by sudden popping sounds coming from the flight deck.

**The noise, loud and sharp,** was caused by movement between the flight deck window and the cab structure when the cabin pressure and outside temperature changed. With just a few weeks until the first customer delivery, the Boeing engineering team, which included Dr. Alain Adjorlolo, knew they had to understand the issue and develop a safe solution.

### MIND ON MATERIALS

Dr. Alain Adjorlolo in front of a 787 Dreamliner. His ideas are used in the production of every one.

PHOTO: MARIAN LOCKHART

Some initially considered redesigning the window frame assembly to stop the slipping, but Adjorlolo had a different idea. He convinced the team to encourage the slipping motion, instead of preventing it.

Given his extensive expertise in corrosion and wear prevention — a discipline that comprehends damage, wear or deformation of material at solid interfaces — Adjorlolo understood that the slipping, although noisy, was safe. To encourage the slipping, he applied a release spray to the window frames of the static test airplane.

A series of on-the-ground simulations on the static airplane and subsequent flight tests on two airplanes proved the solution worked — the popping noise was silenced. The spray helped the team deliver a quality product to the customer and avoid an unnecessary redesign of the flight deck window or window frame. The spray is still used on all 787 airplanes.

“I strongly believe in simple solutions, and I apply that rule to everything I do,” Adjorlolo said.

This photo was taken before Boeing implemented COVID-19 pandemic safeguards.

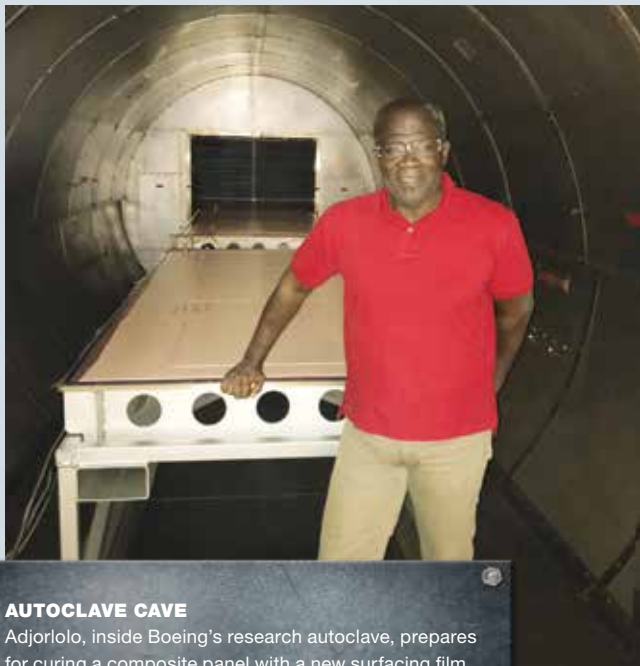

#### AUTOCLAVE CAVE

Adjorlolo, inside Boeing's research autoclave, prepares for curing a composite panel with a new surfacing film.

PHOTO: BOEING

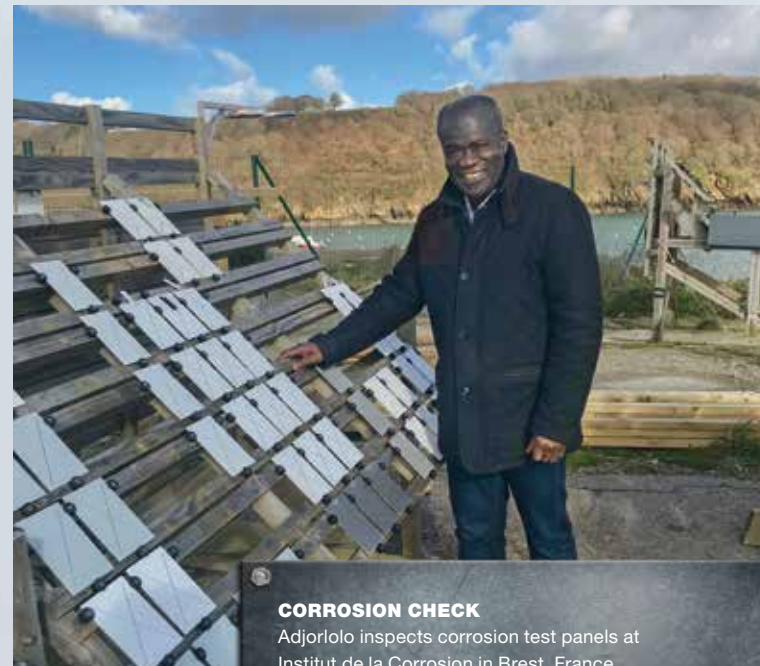

#### CORROSION CHECK

Adjorlolo inspects corrosion test panels at Institut de la Corrosion in Brest, France.

PHOTO: ALAIN ADJORLOLO



**I STRONGLY BELIEVE IN SIMPLE SOLUTIONS, AND I APPLY THAT RULE TO EVERYTHING I DO.”**

DR. ALAIN ADJORLOLO

Throughout his 30-year career at Boeing, he has approached the most complex issues with simplicity in mind. This philosophy was largely influenced by a series of challenges he experienced early in life.

He grew up in Grand-Lahou, a small town in West Africa's Ivory Coast. His parents valued education and inspired Adjorlolo and his 11 siblings to attend college. From a young age, he excelled in math and science.

His father showed his children the way, transitioning from carpenter to trade school teacher and administrator, eventually serving as staff administrator in the Ministry of Technical Education and Professional Training in Abidjan, formerly the capital city.

“I give him credit for everything I've been able to accomplish,” Adjorlolo said.

His father opened up his kids' world through jazz and James Brown, books and stacks of magazines. Adjorlolo began reading *Tout l'Univers*, a weekly science and technology magazine for children, which sparked his interest in materials structures and properties.

“I learned that processing materials of all kinds was a key technology enabler for developing societies,” Adjorlolo said. “I was hooked.”

He wanted to understand why materials behaved the way they did and set his sights on studying metallurgy in college. But the subject was not an available option in his home country.

Undeterred, he pursued and landed a scholarship to study metallurgy at the University of Washington in Seattle.



#### PROUD PARENTS

Adjorlolo's mom, Antoinette Ezueyou, and dad, Lawrence Koissi, at home in Abidjan, Ivory Coast, in 1985.

PHOTO: ALAIN ADJORLOLO

**His father was proud of his son's initiative but was also worried.**

“My dad was primarily concerned about the gun culture and the racism in the U.S.,” Adjorlolo said. “He was quite anxious about my decision to study here.”

And his father's fears were sometimes confirmed. Adjorlolo says he had to get used to living in a place where he was often reminded of his race.

After arriving in the United States and before heading to Seattle, his University of Washington coursework began by taking English language classes at the University of Oklahoma in Norman, Oklahoma. There were times when he was the target of racial slurs while walking to class.

“We had all followed the Civil Rights Movement at home,” he said. “In my mind, I knew there were some areas where I wouldn’t feel welcome and that I’d better be careful.”

After finishing his language classes and transferring to the University of Washington, he credits two professors for helping him make the transition from Africa to America. Dr. Tom Stoebe, an undergraduate adviser, encouraged Adjorlolo to get involved in volunteerism, technical affiliations and mentorship.

“It was clear from the beginning that Alain was a special student who would rise to great heights,” Stoebe said. “The impact of Alain’s activities have been of great social value, especially for students of color. His friendly manner and openness to others is a great gift to all who encounter him.”

Adjorlolo also forged a friendship with Dr. Gordon Orians and his wife, Betty. Like a surrogate mother, Betty helped young Adjorlolo become independent and settle into a new city.

**When a landlord refused to rent him his first Seattle apartment because of his skin color, she stepped in.**

“The previous tenant was Black and trashed the place, so he told Betty in private that he wasn’t going to rent to ‘them’ anymore,” Adjorlolo said. “She really told him a thing or two. Betty was the wrong person to mess with regarding issues of race.”

Armed with bachelor’s and master’s degrees in metallurgical engineering and a doctorate in materials science and engineering from the University of Washington, Adjorlolo landed a job for the national petroleum company back in Ivory Coast.

Four years later, he returned to the United States to develop hands-on material science projects at the University of Washington. He fondly remembers developing laboratory experiments in fabricating materials such as nylon and metallic glasses, with students under the Engineering Coalition of Schools for Excellence in Education and Leadership program. This coalition of schools included several historically Black colleges and universities.



#### X-RAY VISION

As a graduate student in 1983, Adjorlolo familiarized himself with the X-ray diffractometer at the University of Washington in Seattle. The device analyzes a material’s crystal structure.

PHOTO: ALAIN ADJORLOLO



#### HOME AWAY FROM HOME

Adjorlolo found support in his early years in America from two of his University of Washington professors. From left: Alain Adjorlolo, Colin Orians (Betty and Gordon’s son), Jan Stoebe, Dr. Tom Stoebe, Betty Orians and Dr. Gordon Orians in 1983.

PHOTO: KENDAHL ADJORLOLO



#### THE DOCTOR IS IN

Adjorlolo says he “couldn’t believe it was over” as he celebrates graduation day, earning his doctorate at the University of Washington in 1985.

PHOTO: SPENCER SHAW

As a graduate student, Adjorlolo met Dr. John H. Jones, a Boeing engineer who taught materials science part time. Jones invited Adjorlolo to be his teaching assistant. As the friendship blossomed, Jones encouraged him to apply for an engineering position at Boeing. In 1991, Adjorlolo joined Jones’ team at The Boeing Company. Adjorlolo also became Jones’ mentee.

Over the next three decades at Boeing, Adjorlolo achieved international recognition and emerged as a trusted subject matter expert and consultant specializing in corrosion prevention, composite finishes, films and adhesives for airplane design and manufacturing. He holds 16 patent disclosures, including seven granted, and has several publications to his name.

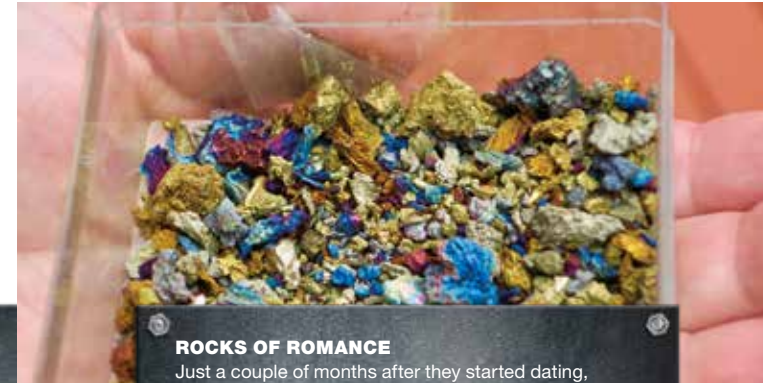

#### ROCKS OF ROMANCE

Just a couple of months after they started dating, Adjorlolo presented this handful of oxidized titanium-sponge nuggets to his girlfriend, Kendahl, in 1983. “These nuggets developed beautiful colors as they reacted inside a high-temperature furnace with the tiny amounts of oxygen impurities in my tanks of pure nitrogen,” he said. “I used the nitrogen for my thesis experiments. The bright, iridescent colors were to remind her of the colors and joy she brought into my life.” They would marry five years later. Kendahl still has them in their original box.

PHOTO: ALAIN ADJORLOLO

He has made lasting, impactful contributions to the 787 program, including the development of a process called Corrosion Risk Assessment/Rectification Impact Assessment (CRA/RIA). These two assessments estimate the design, manufacturing and repair impacts for products. They also help airplane designers decide if aluminum alloys could be used in assembly with carbon composites.

## Being Black in America: A view from Africa

### Born in Ivory Coast, a Boeing engineer reflects

There are a lot of parallels between America and colonized regions in Africa. You’re made to feel as though you can never rise to “white standards” of excellence. There is a tendency to devalue people who are not at that perceived standard.

Growing up in Africa, we have a legacy of colonization. In America, it is slavery. For instance, I am a fluent French speaker as a result of being educated in Ivory Coast, a French-speaking country. But in France, many whites assumed I went to French schools. In America, many white people would ask if the French I spoke was “real French,” as if my education were inferior.

We approach reality from different points of view, language, background and gender. To see reality and solve problems, everyone must feel valued and be heard.

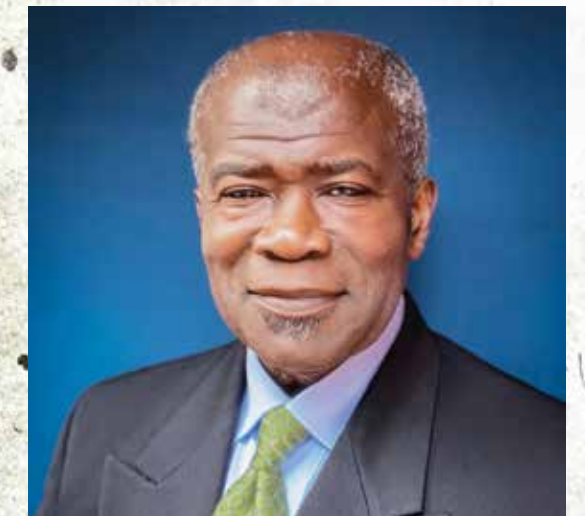

#### DR. ALAIN ADJORLOLO

Adjorlolo was recently honored with a 2021 Black Engineer of the Year Award for Outstanding Technical Contribution.

PHOTO: ALAIN ADJORLOLO

CRA/RIA allows airline customers to potentially increase maintenance intervals for 787 airplanes from eight to 12 years.

**This has become a standard design evaluation tool for 787 airplanes and 777X wing and composite airplane structures.**

Now in the company's Product Development organization, Adjorlolo and his team are creating a road map to improve corrosion testing and better characterize environmentally compliant finishes when used with new and advanced alloys.

When he's not discovering novel ways to improve airplane design and manufacturing, Adjorlolo gives back by helping others further their education. He developed and taught classes to more than 1,000 Boeing engineers at multiple sites across the company, including in Russia.

Adjorlolo also participates in several Boeing programs aimed at helping early-career engineers network and develop their technical skills.



#### GROUP HUG

Christmas 2018 in downtown Seattle. From left: Wife Kendahl; sons Maoulay, Koissi and Bogui; daughter Keely; and Alain Adjorlolo.

PHOTO: BARB BAKER

He maintains a close relationship to his alma mater as a lecturer of Corrosion and Wear of Materials and Introduction to Materials Science and Engineering courses. Many of the materials sciences students he taught at the University of Washington are now Boeing engineers. Like Adjorlolo himself, two of his former students are Boeing Associate Technical Fellows, companywide technical experts. He works side by side with another, as they share a manager.

"It is actually quite exciting to see them as colleagues to share knowledge with," he said.

Adjorlolo is especially interested in guiding young people who have been racially disenfranchised to find their passion in STEM. In cooperation with the University of Washington College of Engineering, he developed the Minority Engineering Program.

"There's a long history of Black achievement that is unknown," Adjorlolo said. "It's important to bring some level of visibility about these achievements to younger generations. There are a lot of people out there who look like them, making significant contributions to society."

As a mentor, Adjorlolo is intentional about developing meaningful, mutually beneficial relationships. "It's a two-way street," he said.

When mentoring engineers, he offers career advice and often shares his personal story to build trust. He encourages mentees to find areas where they can shine.

"My parents seldom explicitly told me what to do except to excel. They had so much lying around. My curiosity just took over," he said.

When reflecting on his journey, with its many twists and turns, Adjorlolo says the biggest lesson is that there is so much we can't control. Just like the popping of the 787 flight deck window, sometimes it's best not to fight movement but, instead, encourage it.

"For the little things you can control, do something about it," Adjorlolo said. "For everything else, learn to move on." **IQ**

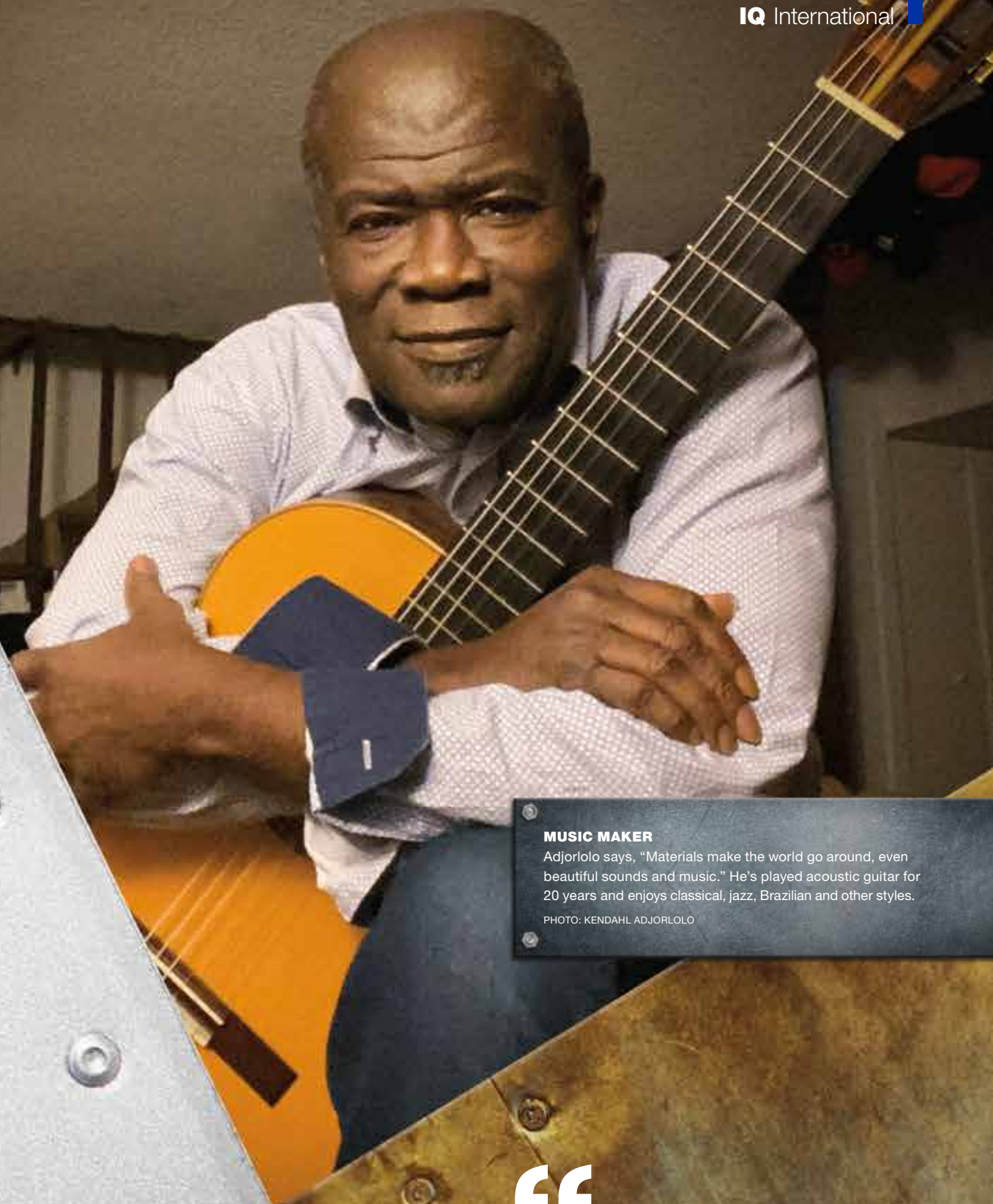

#### MUSIC MAKER

Adjorlolo says, "Materials make the world go around, even beautiful sounds and music." He's played acoustic guitar for 20 years and enjoys classical, jazz, Brazilian and other styles.

PHOTO: KENDAHL ADJORLOLO

“

**THERE'S A LONG HISTORY OF BLACK ACHIEVEMENT THAT IS UNKNOWN.”**

DR. ALAIN ADJORLOLO



# DEFIANT X:

The fastest, most maneuverable, most survivable military helicopter in history is on the horizon

BY RACHELLE LOCKHART AND ED MUIR, BOEING WRITERS

## Defiantly different

**Thirty aircraft, carrying 360 soldiers,** lift into the air and disappear into the night. They fly low and fast, grouped in six formations.

The mission is to secure a sensitive infrastructure complex deep in enemy territory. To get to the landing zone, they will have to fly twice the length of New Jersey, through a web of enemy air defense.

Once at the landing zone, soldiers will travel on foot.

**The helicopters weave through tree lines, a valley, then over a riverbed — too low to show up on radar and too fast for adversaries to even get a shot off.**

### DEFIANT

The highly maneuverable DEFIANT X delivers unmatched survivability in high-threat air defense environments and flies twice as far and twice as fast as the Black Hawk helicopter it is designed to replace.

ILLUSTRATION:  
SIKORSKY-BOEING

“It’s an air assault weapon system with all the advantages of a traditional helicopter and the speed, range and payload of an airplane.”

NATE MORGAN, BOEING ENGINEER

The last mile of flight is the most dangerous. The landing zone is surrounded by hostile forces. Pilots must maneuver the aircraft on the spot to land quickly and smoothly — and then get out the second soldiers disembark.

Speed, reach and maneuverability are critical to mission success and to ensure everyone comes home.

Someday, this imagined scenario could be DEFIANT X in action.

DEFIANT X is an advanced utility helicopter and air assault weapon system that can fly low and fast, land quickly, deliver soldiers to the objective area (known as the “X”) and get out — all while evading the enemy in complex terrain. It will revolutionize the Army’s air assault capability and be the fastest, most maneuverable and most survivable military helicopter in history.

Recently, Sikorsky and Boeing released details about the new aircraft, which is the team’s entry for the U.S. Army’s Future Long Range Assault Aircraft competition, a top modernization priority for the service.

The Army is expected to issue a request for proposals later this year, with contract award anticipated in 2022.

**Nate Morgan** is one of the Boeing engineers working on the DEFIANT X program. His team is involved with system integration, analysis and safety.

“Our role is to ensure all the parts and systems of the aircraft work together, safely and efficiently,” he said.



#### MISSION CRITICAL

Four DEFIANT X aircraft fly in formation at high speed, through contested territory, to deliver mission-critical equipment to the landing zone.

ILLUSTRATION: SIKORSKY-BOEING

Morgan has worked on vertical lift programs since 2013, but he is especially excited about DEFIANT X because it is a clean-sheet aircraft that incorporates state-of-the-art technology and innovation. According to Morgan, four aspects of DEFIANT X make it exceptional.

#### Coaxial Rotor System

Two sets of composite rotors are stacked atop each other. The rotors’ rigidity, along with the pusher prop on the rear of the helicopter, enables DEFIANT X’s game-changing speed, exceptional maneuverability, and enhanced acceleration and deceleration. DEFIANT X will fly at speeds exceeding 230 knots, twice as fast as the Black Hawk helicopter it is designed to replace.

“It’s an air assault weapon system with all the advantages of a traditional helicopter and the speed, range and payload of an airplane,” said Morgan.

#### Fly-By-Wire Flight Controls

Advanced flight control software and pilot interfaces coupled with redundant control surfaces reduce the workload for aircrew and provide the framework for autonomous operation.

#### Composite Fuselage

Advanced materials and manufacturing techniques reduce weight, vibration effects and corrosion in harsh environments.

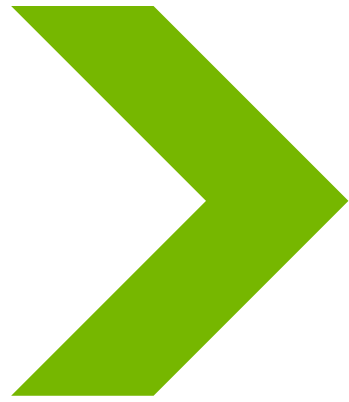

“It’s a special time in the industry to be able to develop a helicopter from paper to proof. This only happens once in a generation.”

NATE MORGAN, BOEING ENGINEER

#### Model-Based Engineering

The tools and processes used to develop DEFIANT X are fully model based. Model-based engineering (MBE) uses a digital system model integrated during all stages of the development in order to form a robust digital thread of program data, which increases first-time quality and safety. This approach also enables early discovery of issues during development; facilitates rapid technology insertion later in the program; and forms the basis of digital twins, which can be used to support the aircraft once fielded.

“This is industry-leading use of MBE, not just in the military helicopter realm,” Morgan said. “We are evolving and innovating processes along the way, and it is an amazing opportunity for the team.

“It’s a special time in the industry to be able to develop a helicopter from paper to proof,” he added. “This only happens once in a generation.” **IQ**

#### ADVANCED

DEFIANT X boasts an advanced coaxial rotor system, pusher prop with clutch, composite fuselage, retractable landing gear, fly-by-wire controls and a cabin for 12 troops — while fitting in the same footprint as the Black Hawk helicopter.

ILLUSTRATION: SIKORSKY-BOEING



#### VIDEO

See DEFIANT X soar.

## VETERANS MAKE US BETTER

Boeing is dedicated to helping veterans and their families. We support health and wellness programs for recovery and rehabilitation and high-quality training and career development programs for the nearly 15% of our U.S.-based workforce who self-identify as veterans. Their leadership, commitment and selflessness are invaluable assets.

[boeing.com/careers](https://boeing.com/careers)      

Boeing is an Equal Opportunity Employer. Employment decisions are made without regard to race, color, religion, national origin, gender, sexual orientation, gender identity, age, physical or mental disability, genetic factors, military/veteran status or other characteristics protected by law.





# Libation to innovation

**Beer keg helped Boeing engineers conduct critical testing for world's first pressurized airliner**

BY ANNIE FLODIN AND MIKE LOMBARDI,  
BOEING HISTORICAL SERVICES

**Beer doesn't often play a role in aerospace innovation. But there is a notable exception.**

The Boeing Model 307 Stratoliner is an airplane of many "firsts." It was the first four-engine airliner in scheduled domestic service. The Stratoliner was also the first to employ a flight engineer as part of its crew. But most important for lovers of a fine lager, it was the world's first high-altitude commercial transport, thanks to its pressurized cabin — and thanks to a beer keg.

In the late 1930s, Boeing engineers were hard at work designing a commercial version of the Model 299/B-17 bomber. The new airplane — the Model 307 — used the B-17's wings, engines and tail surfaces. But it was different in one big way: Its fuselage was much bigger. Some could say noticeably rotund. But this massive, perfectly circular space allowed the airplane to be pressurized.

As a result, it could fly above rough weather at altitudes reaching 20,000 feet (6,096 meters).

Other pressurized aircraft had to constantly pump unregulated, compressed air into the cabin, making for a rather uncomfortable and potentially dangerous flight. To get around those issues, Boeing engineers invented a pressure regulator that would improve both safety and comfort.

When it came time to test the regulator, the engineers approached company leadership to ask for funding to build a pressure test lab. Unfortunately, in the throes of the Great Depression, funds were scarce.

The airplane was given the name Stratoliner, a nod to the stratosphere.



#### ABOVE IT ALL

Pan Am's Clipper Flying Cloud — one of 10 Model 307 Stratoliners built by Boeing — is now on display at the Smithsonian National Air and Space Museum.

PHOTO: BOEING ARCHIVES. IMAGE ALTERED FOR LAYOUT.

**But Boeing engineers were determined. And they found their answer in a local junkyard.**

In a moment of innovative genius, they purchased a discarded beer keg. They suspected it would be the perfect pressure test vessel. This early example of recycling allowed them to test and verify a workable cabin pressure regulator that was then patented and put into production on the Boeing Model 307.

Because of its ability to operate at high altitudes, the airplane was given the name Stratoliner, a nod to the stratosphere. It was the third Boeing aircraft to receive an official name in addition to its model number.

With individual aircraft called Rainbow, Comet and Flying Cloud, the Model 307 entered service with Pan American Airways in 1940 and set new standards for speed and comfort. And yes, beer was occasionally served on board. **IQ**



#### RECYCLING PIONEERS

A lack of funding inspired Boeing engineers to think outside the box and inside the junkyard to test their cabin pressure regulator. They salvaged this discarded beer keg and used it to build a pressure controls test module.

PHOTO: BOEING ARCHIVES

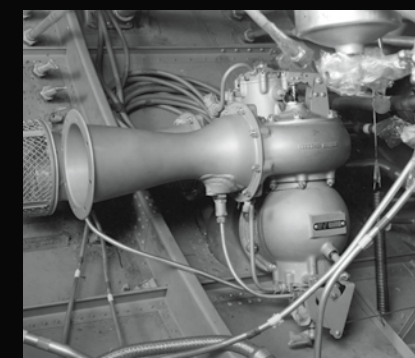

#### RESULTING REGULATOR

The cabin pressure regulator designed by Boeing engineers allowed the Stratoliner to fly above rough weather, making for a safer and more comfortable flight.

PHOTO: BOEING ARCHIVES

# CYBER SECURITY GUARD

## Q&A with a product security engineer

**Boeing product security engineer Anna Guthrie supports the Missile and Weapon Systems' Ground-based Midcourse Defense program. She recently won the DEF CON Aviation Information Sharing and Analysis Center (A-ISAC) Capture the Flag challenge, a 24-hour cybersecurity competition. In this Q&A, she offers a glimpse into a day in her life plus three tips to staying cyber safe.**

### **IQ: What do you do on a daily basis?**

**Guthrie:** With the clock counting down and the movie hero's safety on the line, the techie character types frantically on the keyboard. "I'm in!" she says, coming to the rescue just in time. Those movie moments, although sped up and dramatized, often remind me of my role. I help make sure systems are able to withstand cyberattacks. Each day I come to work with permission and encouragement to break and fix systems — repeatedly!

My team and I also get to create and deploy new tools to make this process more efficient. The goal is to win the race, and we win by finding and fixing any potential vulnerabilities before adversaries discover or exploit them. My job feeds my naturally competitive spirit. Each day, I get to increase the cyber resiliency of Boeing products and help keep us safer as a company and as a nation.

**IQ: Why cybersecurity?**

**Guthrie:** Cybersecurity was a natural path for me. I've been into computers as long as my fingers could type on a keyboard.

I was the 5-year-old taking apart Mom's printer, the 10-year-old bypassing the password on some of our home computers and the 14-year-old writing BAT files as pranks.

**I was one of only two girls in my high school computer science classes and was advised that, as a woman, I wouldn't succeed in a tech field. I took that as a challenge.**

That offhand comment helped decide my major in college.

When I finally got to Brigham Young University, I started in information technology. I then switched to cybersecurity as soon as the major became available my junior year. I ended up being the only female to graduate in cybersecurity from my school that year.

As I approached graduation, I knew I wanted to work with a defense contractor. I find a lot of value in creating more-resilient technology and systems for the cause of national defense.

Joining Boeing's cyber program was an absolute dream come true. I've been able to work with and learn from fantastic teammates on engaging, technical, cross-enterprise projects while supporting national defense.

Boeing's cyber program is still growing, and I'm thoroughly enjoying the opportunity to contribute to and steer the program. I love knowing that I make a difference and my voice is heard and considered.

**IQ: What do you like about the job?**

**Guthrie:** It's gratifying to leave work for the day saying, "Today I helped make our nation safer!"

My favorite aspect of the cybersecurity field is it is always changing. It forces you to stay up to date and relevant. I continue to learn every day.

My team's projects have been technical and hands-on, and I'm constantly creating new techniques and technologies to increase efficiency and effectiveness. There are many opportunities for simultaneous, technical, diverse projects too. I enjoy having the freedom to switch between projects and change it up each day.

I am also privileged to work with brilliant, dedicated, hardworking colleagues. I love being a part of a global team with a common goal. **IQ**

**CYBER WINNER**

Product security engineer Anna Guthrie recently won a 24-hour cybersecurity competition.

PHOTO: ANNA GUTHRIE

**Device advice****Three must-know cybersecurity tips**

**1 Resist the click:** Don't click on links or open attachments from unknown sources. This applies to text messages, emails, online searches and anything else you can think of. Validate that any software, browser extension, app, update package or email attachment you decide to open, save, install or use comes from a trusted source.

**2 Pass on passwords:** Use passphrases instead of passwords (and don't reuse them). While previous security suggestions for passwords included tips like "use numbers instead of letters and throw in some special characters," these tips may not actually be as helpful as they may seem. A computer will guess "p455w0rd!" just as easily as "password!" Instead, use a passphrase, such as "PurpleElephantsWear-Bloomers." Passphrases are usually longer than a typical password. (In fact, the longer they are, the better; this drastically increases password security.) And if they evoke a funny mental image, passphrases are much easier for a human to remember.

**3 Freshen up:** Update your systems regularly. Vendors release security patches for newly discovered vulnerabilities frequently. Stay up to date to avoid being attacked with these exploits. Also, although some systems will automatically update themselves, remember to consider the Internet of Things devices in your life — your watch, doorbell, security camera or thermostat will also need to be updated, just like a laptop, phone or computer tower.

**ANNA GUTHRIE**

**“ Each day I come to work with permission and encouragement to break and fix systems — repeatedly!”**

**ANNA GUTHRIE**

# PatentPower

Boeing's latest ideas and technical breakthroughs recently granted or published by the U.S. Patent and Trademark Office

## Lasting Light

**U.S. PATENT:** 10,852,638  
"Systems and Methods for Operating a Light System"

**INVENTOR:** Associate Technical Fellow Melanie L. Kimsey-Lin is a Boeing systems engineer in Product & Services Safety.

### Melanie Kimsey-Lin took to science early.

"Growing up, I really liked science fiction books and shows like 'Star Trek' and 'Dune.' And my dad was always tinkering in the garage," she said. "So I picked up a lot of my curiosity about how things work from him."

Becoming an inventor was not a goal but a happy consequence of her work. "Labs and experiments always appealed to me," she said. And to see her efforts result in a product is "kind of a bonus."

One such bonus is recently issued U.S. Patent No. 10,852,638, "Systems and Methods for Operating a Light System," which is one of a series of patents for disinfecting an environment with ultraviolet light.

**This particular patent describes a method of maintaining the same strength of the light over a period of time to also maintain the same kill rate for bacteria and viruses.**

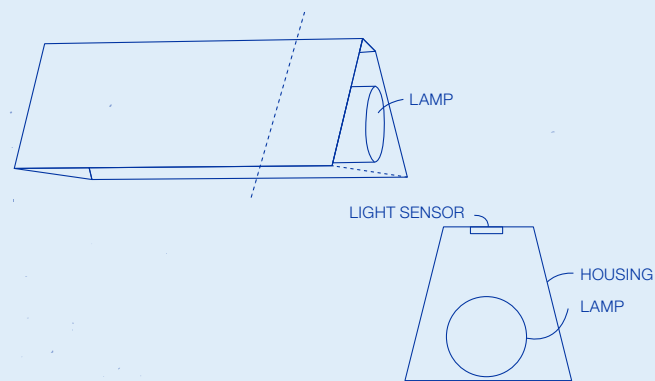

**LIGHT SOURCE**  
Perspective and cross-section views of the UV light source that includes the light sensor above the lamp.

GRAPHIC: BOEING

Previous attempts allowed electrical input that resulted in a reasonable output throughout the bulb life but did not change input to compensate for degradation or environmental conditions. Kimsey-Lin devised a method to provide a power supply that adjusts the voltage or frequency to the UV light source as the output changes.

### The goal is to achieve uniform performance throughout the bulb's life.

This way, a 2-year-old light is just as effective for disinfection as a new light.

**Unaware of what was to come, the invention disclosure was filed in 2017, well before the COVID-19 pandemic.**

Having more than two years of development for this technology provided a critical head start for Boeing's efforts to provide cleaner, healthier aircraft environments.

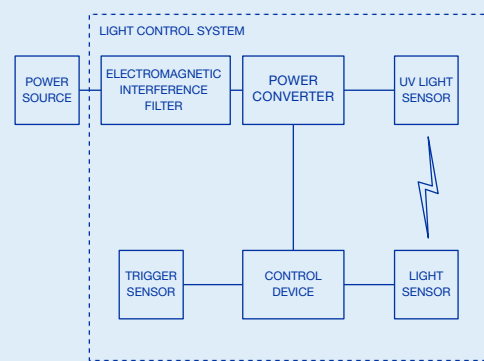

**CYCLE OF LIGHT**  
From the official U.S. Patent: "The control device and the light sensor can dynamically adjust operation of the power converter to maintain the target level of antimicrobial efficacy over a plurality of activation cycles of the UV light source."

GRAPHIC: BOEING

## Sensor and Sensibility

**U.S. PATENT:** 10,871,405  
"Indicator Device and Method"

**INVENTOR:** Associate Technical Fellow Paul G. Vahey works in chemical technology integration for Boeing Research & Technology.

### Paul Vahey calls himself a helper.

"I'm much better at tweaking than coming up with the first article. I enjoy helping you improve," he said.

When he saw a sensor developed by the University of Washington for nondestructive monitoring of thermal exposure, he sensed an opportunity. Given his background as an analytical chemist, he suspected the device might need modification to be used for its intended purpose, monitoring temperatures in airplane engines.

The material in the sensor changed color the more it was heated. However, it was originally placed on a transparent material and interrogated using fluorescence spectroscopy, which made it highly susceptible to interference from surrounding materials, especially when those materials also fluoresce.

### Vahey figured out how to add a reflective layer between the material of the sensor and the material it was testing.

The result was U.S. Patent No. 10,871,405, "Indicator Device and Method." Not only does this improvement make for a stronger, faster sensor that is less susceptible to interference, but it also allows the sensor to be used on any surface.

Vahey and his University of Washington colleagues were able to collaborate freely because Boeing and the university had an agreement in place that defined intellectual property ownership rights.

### They were energized by the challenge of figuring out how to transform material in the lab into a real-world application.

Last year, the thermal tape made its debut during testing. This year, it will likely get its second flight on a Boeing test plane.

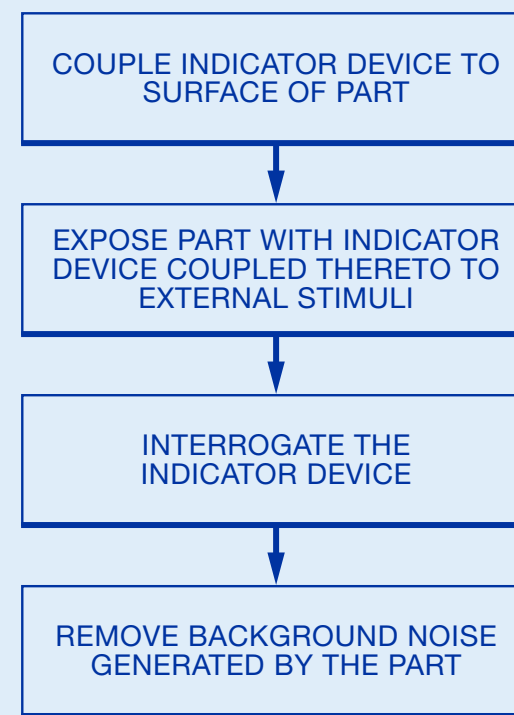

**STOP THE NOISE**  
The indicator device is coupled to a surface of the part during testing/manufacture of the aircraft or during normal operation. The device is interrogated. Background noise from the part is blocked by the reflective layer.

GRAPHIC: BOEING

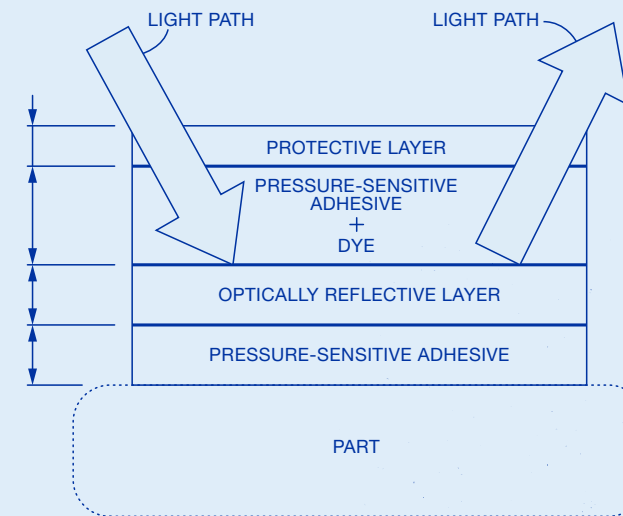

**LAYERED APPROACH**  
Cross-section schematic of the indicator device that provides for nondestructive evaluation of external stimuli (such as thermal effects and mechanical forces) on any suitable parts, such as aircraft parts.

GRAPHIC: BOEING

**NEW TEACHING METHODS**

Brandon Chapman teaches engineers how to perform fatigue analysis of structural joints.

This photo was taken before Boeing implemented COVID-19 pandemic safeguards.

PHOTO: TAYLER WILEY



# ENGINEER TRAINING THAT WORKS

**A new way of interactive teaching is helping Boeing engineers retain crucial knowledge**

**When travelers fly on a Boeing airplane**, they rightly expect the aircraft will maintain structural integrity in the presence of repeated loading, corrosion or other forms of damage that may occur in operation, such as foreign object impact or a lightning strike. So engineers involved in structural design and analysis need to have extensive knowledge in **durability and damage tolerance (DaDT)**, which plays a critical role in the safety and economics of the airframe. Their expertise overlaps with that of engineers who specialize in load design, manufacturing, systems engineering, and materials and process technology.

However, most U.S. undergraduate engineering programs do not cover DaDT in depth. That's where Boeing's revamped and updated training comes in.

**The need for a new learner experience**

The Structures Engineering team developed introductory DaDT classes more than 20 years ago. Courses cover the fundamentals of durability, fail safety and damage tolerance. For decades, those classes were long lectures with intricate slides. The learning was passive. And since some engineers couldn't put their knowledge into practice right away, retention was a concern.

To address these challenges, the team developed a pilot program designed to restructure the training, making it easier for the learner to access and retain crucial knowledge. A new daylong workshop uses modern methods to engage and teach engineers in two areas: **inductive learning** and **active learning**.

A team of technical experts along with an internal learning development organization, Structures University, recognized that not all engineers will immediately encounter DaDT in their functions. So the group focused on **inductive learning** (also known as backward teaching), which is inquiry and problem based. Rather than begin the class with a lecture on the mathematical equations of fracture mechanics, the instructor first presents the students with a challenge (e.g., the damage of an in-service part) and then gradually introduces the underlying theory and methods.

In this way, the process of finding the solution to the problem is now primarily a learner-centered activity, involving iterative loops as the students incrementally gain the necessary tools they need.

**Active learning** is anything students do in class to learn material, other than listen to the instructor and take notes, with the key activity and engagement elements. The team employed several examples of active learning techniques across a broad spectrum, ranging from interactive polls and quizzes to more-structured, team-based activities. In one tutorial activity, the students are given a simple spreadsheet analysis tool and then

challenged to work together to answer a series of questions. Learning that is hands-on and experiential tends to be more effective because the learner can do something and get immediate feedback.

**Active and engaged students**

The goal was to create an environment where the students could be active and engaged, make attempts to apply their learning, struggle with the material — even make mistakes — and receive feedback from their peers and the instructor.

Engineers who will engage in DaDT analysis can advance to more in-depth training classes. The training was first offered in late 2016 to Boeing structures engineers in Everett, Washington, and has since spread to other Boeing sites. It has been deployed both in-person and, more recently, virtually in Renton, Washington; Seal Beach, California; Charleston, South Carolina; Moscow, Russia; Kyiv, Ukraine; and Melbourne, Australia. **IQ**

**BOEING TECHNICAL JOURNAL**

The Boeing Technical Journal is a peer-reviewed, proprietary periodical for Boeing subject matter experts to capture and share knowledge. This article is a summary of "Effective Durability and Damage Tolerance Training: New Methods for Modern Learners," an article originally published Nov. 11, 2020.

**About the Author:**

Brandon Chapman is a structural analysis engineer in the Boeing Commercial Airplanes Structural Damage Technology group. He also teaches classes on structural durability and damage tolerance.

**Structural analysis engineer  
Mark Mansfield donated his  
100th gallon of blood**

# Starliner star

**100**  
gallons donated (378 liters)

**2,400**  
lives saved or  
sustained



**STAR DONOR**

Starliner engineer  
Mark Mansfield  
donates blood at the  
OneBlood facility in  
Orlando, Fla.

PHOTO: PAT MICHAELS,  
ONEBLOOD

**Mark Mansfield recently marked an incredible milestone.**

He donated his 100th gallon (378 liters) of blood, over a donor “career” spanning 39 years. The Florida resident, a Boeing structural analysis engineer, has donated regularly at the OneBlood donor facility in Orlando, and OneBlood estimates Mansfield has saved or helped sustain an incredible 2,400 lives through his blood and platelet donations. He is one of fewer than 300 Floridians who have donated at least 100 gallons of blood.

Mansfield is busy working at the Commercial Crew and Cargo Processing Facility at Kennedy Space Center in Florida, supporting the Boeing CST-100 Starliner. But he always makes time to donate blood.

“I hope my story will encourage others to become blood donors too,” Mansfield said. **IQ**

# Spring - Loaded Innovation

## How to get there and stay there

Innovation is like a spring. Systems engineer Marna Kagele explores how we load that spring and harness its power.



### ABOUT THE AUTHOR

Marna Kagele is a Boeing Technical Fellow in systems engineering and strategic foresight and a real-life rocket scientist.

PHOTO: MARIAN LOCKHART

### We can sense innovation.

If asked to name an innovative company, most of us will rapidly list several. Identifying an innovative company is easy. The criteria we use are likely related to what we see the companies producing and the way they function.

But finding out how they sustain innovation is more difficult. Then determining how we can ensure continuous innovation in our own company is even harder. This has been explored in numerous studies, with no shortage of recommendations. But in practice, there is no one-size-fits-all answer.

Most of the commonly used innovation metrics are selected because they are readily measured. Unfortunately, this method is wrought with pitfalls because the measures don't correspond to actual innovation results, can be misleading in isolation, and offer little insight into the actual state of innovation or areas needing improvement.

It is also important to consider that simply knowing we are innovative is not enough. Effective measures should direct attention to those areas needing improvement and tell us the impact if changes are made.

### The Portfolio

Measuring innovation is most effective when tailored for an individual company and its innovation goals. For example, is the company seeking to create a new market, improve an existing offering or become the top market leader? Effective innovation will look different in each case. So begin with a company's strategy. Measures chosen should point to areas that need improvement or where current assumptions are incorrect. The intent should be to track any change as a result of actions taken and then use findings to enhance innovation culture, tools, resources and support systems.

### The Framework

Innovation starts with a strong foundation, including:

- A clear strategy.
- Talented, diverse people.
- Dedicated funding.
- Support programs.

These elements are like the potential energy of the company just waiting to be transformed into kinetic energy. They could result in patents, papers, products, services, low employee turnover and other desirable outcomes. However, friction in the system can limit the amount of potential energy that is ultimately realized.

Think of innovation as a spring, which is intentionally designed for repeated force. It requires compression and then draws on its design attributes to release kinetic energy.

The spring is the design of our innovation system. The compression is our innovative action. The release is the result.

### The Measures

The spring analogy illustrates the three categories for meaningful measures of innovation:

- Capacity
- Transformation
- Evidence

### HELLO, SPRING

Innovation is like a spring that compresses and releases kinetic energy when resources are applied by empowered employees.





# Plan for trial and error to arrive at an effective set of measures for your situation.

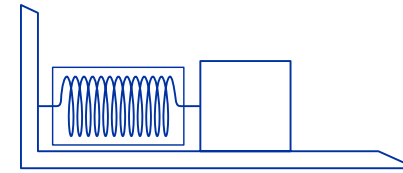
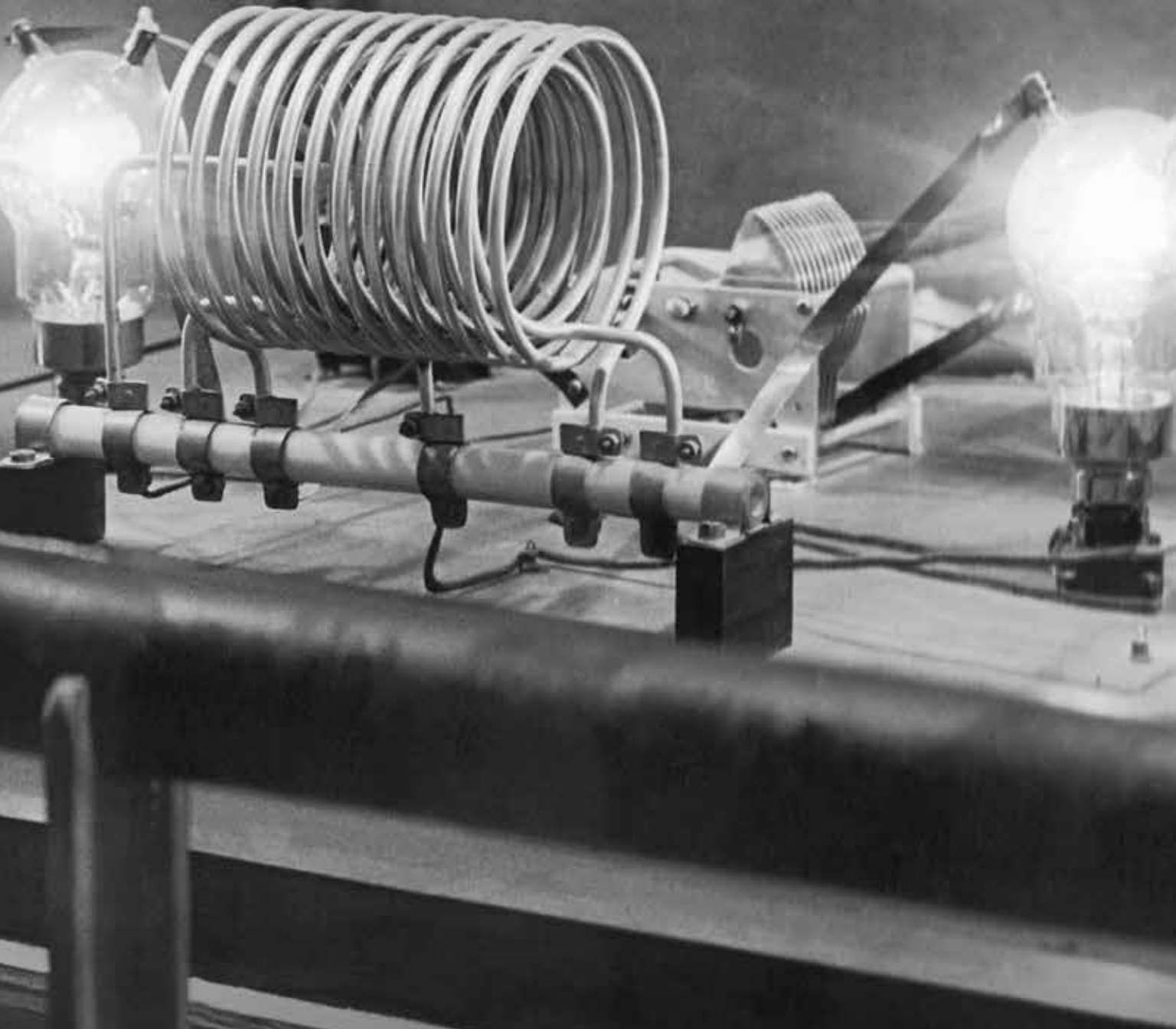

**Capacity:** Just like a spring's design, the way a company's innovation enablers are constructed determines its capacity for potential innovation. Useful measures include the right people, exposure to innovation stimuli, tools, and training and committed funding.

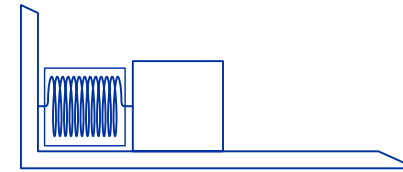

**Transformation:** As the spring compresses — as employees access resources — potential energy builds. Useful measures include awareness, engagement and utilization.

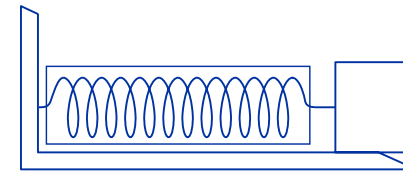

**Evidence:** The release of the spring, its expression of kinetic energy, results in evidence of innovative activity. Useful measures include collateral, speed to learning and portfolio movement.

## The Assessment

These three measure categories can be assessed individually to reveal strengths and weaknesses. For example, one might see that their company has low transformation but high capacity. This would indicate there is room to increase innovation by focusing on more engagement and utilization of current programs.

Or maybe there are many programs, but transformation is low because they aren't the right programs for employees' needs. Similarly, low capacity with high evidence indicates innovative capability despite internal high barriers. Thus, measuring these segments separately directs us to specific areas of improvement.

## The Selection

Start by getting a sense of barriers to innovation. In every company, there are hypotheses and assumptions about strengths and barriers to innovation, proven or not. Measurement will establish the truth of those hypotheses and will reveal other issues.

Measures should be selected to not only test our hypotheses but also give us information about the full framework of capacity-transformation-evidence. Put them into practice to establish a baseline and adjust from there. It is unlikely those chosen initially will be ideal. Plan for trial and error to arrive at an effective set of measures for your situation.

One should also determine a time frame to revisit measures to ensure they are still useful and insightful. Note that measuring and increasing the effectiveness of innovation is not a passive or static process. It must be actively managed and continually adapted as the organization grows and changes.

## The Consequences

Every measure drives employee behavior, and there can be unintended consequences. It is important to anticipate responses to ensure measures activate strategic goals and do not lead to less-desirable actions.

For example, if an organization is solely measured on its patent generation, it might forgo less-promising, riskier ideas and only generate technical work in areas likely to become an invention. Incremental and risky innovations would be avoided, and the company could miss potential valuable contributions.

A company with low patent filings would show as lacking innovation capability, when in reality, numerous business reasons, unrelated to innovation, drive the decision to move forward with a patent filing. However, we do not need to avoid these measures altogether. They can be very useful when included in a portfolio of measures.

In general, when selecting measures, there is a need to watch for the development of reactionary behaviors. All measures drive behavior, even how work is performed.

The leading or lagging nature of measures is another factor to consider based on what one is seeking to understand. Many measures, such as the number of technical publications produced, reflect activity from a wide time frame. If we have recently made changes to our innovation enablers, we won't see the results reflected in that measure.

## The Conclusion

There is no single answer for how to ensure your company is innovative and stays that way. You can, however, spot areas that need attention by selecting and monitoring indicators using the capacity-transformation-evidence framework. And that will empower your company to spring into innovation. **IQ**

# Night Light

Test launch off the California coast

## PHOTOGRAPHER

Christopher Okula, U.S. Space Force

## DATE

Feb. 23, 2021

## TIME

11:49 p.m. PST

## PLACE

From Vandenberg Air Force Base, California, toward the Pacific Ocean

## EVENT

First Minuteman III intercontinental ballistic missile (ICBM) test launch of 2021

## U.S. Space Force scientific photographer

Christopher Okula was 4,400 feet (1,341 meters) from the launch facility and opened the shutter on his camera five seconds into the flight (to counter overexposure at liftoff) for 104 seconds.

“A Minuteman III begins its flight with a sudden and tremendous roar,” he said. “If I had to compare it to anything else on earth, I’d say it sounds most like a rushing waterfall being poured directly into your ear. The roar fades as the missile climbs, and the silence that grows around you leaves you feeling awestruck and alone.” **IQ**

## Minuteman III by the numbers

**Height:**  
**59.9 ft**  
(18.3 m)

**Weight:**  
**79,432 lbs**  
(36,030 kg)

**Top speed:**  
**15,000 mph**  
(24,140 kph)

**Maximum range:**  
**>6,000 mi**  
(>9,600 km)



## BONUS IQ TOPSHOT

See two KC-46A Pegasus tankers soar.



# BUILDING THE FUTURE TOGETHER

Diversity and inclusion are part of Boeing's values at the deepest level, and we proudly celebrate our team coming together to raise the bar for change.

[boeing.com/careers](https://www.boeing.com/careers)



Boeing is an Equal Opportunity Employer. Employment decisions are made without regard to race, color, religion, national origin, gender, sexual orientation, gender identity, age, physical or mental disability, genetic factors, military/veteran status or other characteristics protected by law.

This photo was taken before Boeing implemented COVID-19 pandemic safeguards.

